

JVC

SERVICE MANUAL

WIDE LCD PANEL TELEVISION

**LT-26A61BJ, LT-26A61BU, LT-26A61BU_{IC},
LT-26A61SJ, LT-26A61SU, LT-26A61SU_{IC},
LT-32A61BJ, LT-32A61BU, LT-32A61BU_{IC},
LT-32A61SJ, LT-32A61SU, LT-32A61SU_{IC}**

BASIC CHASSIS

FT

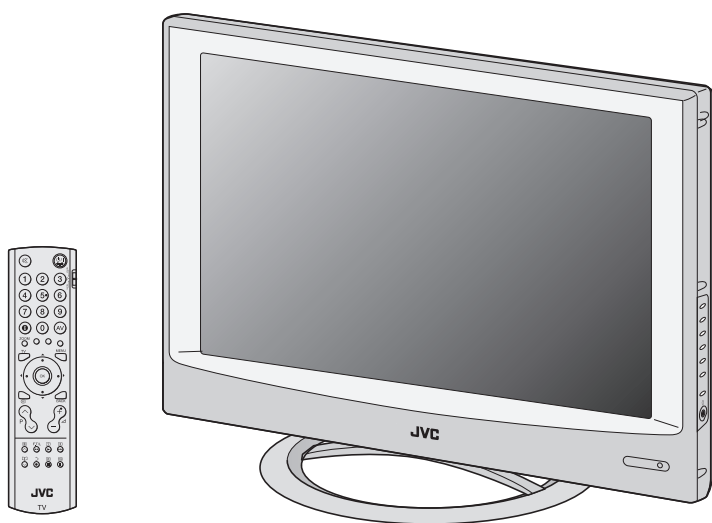

InteriArt
T-V LINK
HD
ready

TABLE OF CONTENTS

1	PRECAUTION.....	1-3
2	SPECIFIC SERVICE INSTRUCTIONS.....	1-7
3	DISASSEMBLY.....	1-10
4	ADJUSTMENT.....	1-15
5	TROUBLESHOOTING.....	1-19

SPECIFICATION

Items	Contents	
	LT-26A61BJ LT-26A61BU LT-26A61SJ LT-26A61SU	LT-32A61BJ LT-32A61BU LT-32A61SJ LT-32A61SU
Dimensions (W × H × D)	68.6 cm × 52.5 cm × 26.9 cm [Included stand] 68.6 cm × 47.4 cm × 12.1 cm [TV only]	82.0 cm × 60.2 cm × 26.9 cm [Included stand] 82.0 cm × 55.1 cm × 12.7 cm [TV only]
Mass	14.9 kg [Included stand] 12.3 kg [TV only]	18.8 kg [Included stand] 15.4 kg [TV only]
Power Input	AC110V - AC240 V, 50 Hz / 60 Hz	
Power Consumption	158 W (Standby: 2.1 W)	
TV RF System	CCIR (B/G, I, D/K, L)	
Colour System	PAL, SECAM, NTSC 3.58/4.43 [EXT only]	
Stereo System	NICAM (B/G, I, D/K, L), A2 (B/G, D/K)	
Teletext System	FLOF (Fasttext level 2.5), TOP, WST(World Standard system)	
Receiving Frequency	VHF: 47MHz - 470MHz UHF: 470MHz - 862MHz	
Intermediate Frequency	VIF	38.9MHz (B/G, I, D/K, L)
	SIF	33.4MHz (5.5MHz :B/G) 32.9MHz (6.0MHz :I) 32.4MHz (6.5MHz :D/K)
Colour Sub Carrier Frequency	PAL	4.43MHz
	SECAM	4.40625MHz / 4.25MHz
	NTSC	3.58MHz / 4.43MHz
LCD panel	26V-inch wide aspect (16 : 9)	32V-inch wide aspect (16 : 9)
Screen Size	Diagonal : 66 cm (H: 57.6 cm × V: 32.4 cm)	Diagonal : 80 cm (H: 69.7 cm × V: 39.2 cm)
Display Pixels	Horizontal : 1366 dots × Vertical : 768 dots (W-XGA)	
Audio Power Output	5 W + 5 W	
Speaker	6.6 cm, round type × 2 (Oblique corn)	
Aerial terminal (VHF/UHF)	75 Ω unbalanced, coaxial	
EXT-1 / EXT-2 (Input / Output)	21-pin Euro connector (SCART socket) × 2	
EXT-3 (Input)	S-Video	Mini-DIN 4 pin × 1 Y: 1 V (p-p), Positive (Negative sync provided), 75 Ω C: 0.286 V (p-p) (Burst signal), 75 Ω
	Video Audio	1 V (p-p), Positive (Negative sync provided), 75 Ω, RCA pin jack × 1 500 mV (rms), High impedance, RCA pin jack × 2
EXT-4 (Input)	Component Video 1125i/750p	RCA pin jack × 3 Y : 1 V (p-p) (Sync signal: ±0.35V(p-p), 3-value sync.), 75Ω Pb/Pr : ±0.35V(p-p), 75 Ω
	625p / 525p / 625i / 525i	Y : 1 V (p-p), Positive (Negative sync provided), 75 Ω Cb/Cr : 0.7V(p-p), 75 Ω
DIGITAL Input	DVI-D signal link 19pin connector × 1(Digital-input terminal is not compatible with computer signal)	
Headphone	3.5 mm stereo mini jack × 1	
Remote Control Unit	RM-C1816S (AA/R6 dry cell battery × 2)	

Design & specifications are subject to change without notice.

SECTION 1 PRECAUTION

1.1 SAFETY PRECAUTIONS [EXCEPT FOR UK]

- (1) The design of this product contains special hardware, many circuits and components specially for safety purposes. For continued protection, no changes should be made to the original design unless authorized in writing by the manufacturer. Replacement parts must be identical to those used in the original circuits. Service should be performed by qualified personnel only.
- (2) Alterations of the design or circuitry of the products should not be made. Any design alterations or additions will void the manufacturer's warranty and will further relieve the manufacturer of responsibility for personal injury or property damage resulting therefrom.
- (3) Many electrical and mechanical parts in the products have special safety-related characteristics. These characteristics are often not evident from visual inspection nor can the protection afforded by them necessarily be obtained by using replacement components rated for higher voltage, wattage, etc. Replacement parts which have these special safety characteristics are identified in the parts list of Service manual. **Electrical components having such features are identified by shading on the schematics and by (Δ) on the parts list in Service manual.** The use of a substitute replacement which does not have the same safety characteristics as the recommended replacement part shown in the parts list of Service manual may cause shock, fire, or other hazards.
- (4) **Don't short between the LIVE side ground and ISOLATED (NEUTRAL) side ground or EARTH side ground when repairing.**
Some model's power circuit is partly different in the GND. The difference of the GND is shown by the LIVE : (\perp) side GND, the ISOLATED (NEUTRAL) : ($\frac{\perp}{\text{---}}$) side GND and EARTH : (\oplus) side GND.
Don't short between the LIVE side GND and ISOLATED (NEUTRAL) side GND or EARTH side GND and never measure the LIVE side GND and ISOLATED (NEUTRAL) side GND or EARTH side GND at the same time with a measuring apparatus (oscilloscope etc.). If above note will not be kept, a fuse or any parts will be broken.
- (5) When service is required, observe the original lead dress. Extra precaution should be given to assure correct lead dress in the high voltage circuit area. Where a short circuit has occurred, those components that indicate evidence of overheating should be replaced. Always use the manufacturer's replacement components.

(6) Isolation Check (Safety for Electrical Shock Hazard)

After re-assembling the product, always perform an isolation check on the exposed metal parts of the cabinet (antenna terminals, video/audio input and output terminals, Control knobs, metal cabinet, screw heads, earphone jack, control shafts, etc.) to be sure the product is safe to operate without danger of electrical shock.

a) Dielectric Strength Test

The isolation between the AC primary circuit and all metal parts exposed to the user, particularly any exposed metal part having a return path to the chassis should withstand a voltage of 3000V AC (r.m.s.) for a period of one second. (. . . . Withstand a voltage of 1100V AC (r.m.s.) to an appliance rated up to 120V, and 3000V AC (r.m.s.) to an appliance rated 200V or more, for a period of one second.) This method of test requires a test equipment not generally found in the service trade.

b) Leakage Current Check

Plug the AC line cord directly into the AC outlet (do not use a line isolation transformer during this check.). Using a "Leakage Current Tester", measure the leakage current from each exposed metal part of the cabinet, particularly any exposed metal part having a return path to the chassis, to a known good earth ground (water pipe, etc.). Any leakage current must not exceed 0.5mA AC (r.m.s.). However, in tropical area, this must not exceed 0.2mA AC (r.m.s.).

Alternate Check Method

Plug the AC line cord directly into the AC outlet (do not use a line isolation transformer during this check.). Use an AC voltmeter having 1000 Ω per volt or more sensitivity in the following manner. Connect a 1500 Ω 10W resistor paralleled by a 0.15 μ F AC-type capacitor between an exposed metal part and a known good earth ground (water pipe, etc.). Measure the AC voltage across the resistor with the AC voltmeter. Move the resistor connection to each exposed metal part, particularly any exposed metal part having a return path to the chassis, and measure the AC voltage across the resistor. Now, reverse the plug in the AC outlet and repeat each measurement. Any voltage measured must not exceed 0.75V AC (r.m.s.). This corresponds to 0.5mA AC (r.m.s.). However, in tropical area, this must not exceed 0.3V AC (r.m.s.). This corresponds to 0.2mA AC (r.m.s.).

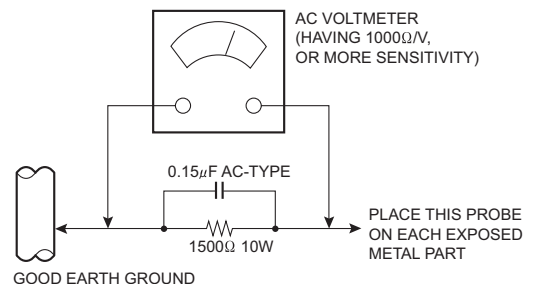

1.2 SAFETY PRECAUTIONS [FOR UK]

- (1) The design of this product contains special hardware and many circuits and components specially for safety purposes. For continued protection, no changes should be made to the original design unless authorized in writing by the manufacturer. Replacement parts must be identical to those used in the original circuits. Service should be performed by qualified personnel only.
- (2) Alterations of the design or circuitry of the product should not be made. Any design alterations or additions will void the manufacturer's warranty and will further relieve the manufacturer of responsibility for personal injury or property damage resulting therefrom.
- (3) Many electrical and mechanical parts in the product have special safety-related characteristics. These characteristics are often not evident from visual inspection nor can the protection afforded by them necessary be obtained by using replacement components rated for higher voltage, wattage, etc. Replacement parts which have these special safety characteristics are identified in the Parts List of Service Manual. Electrical components having such features are identified by shading on the schematics and by () on the Parts List in the Service Manual. The use of a substitute replacement which does not have the same safety characteristics as the recommended replacement part shown in the Parts List of Service Manual may cause shock, fire, or other hazards.
- (4) The leads in the products are routed and dressed with ties, clamps, tubing's, barriers and the like to be separated from live parts, high temperature parts, moving parts and / or sharp edges for the prevention of electric shock and fire hazard. When service is required, the original lead routing and dress should be observed, and it should be confirmed that they have been returned to normal, after re-assembling.

WARNING

- (1) The equipment has been designed and manufactured to meet international safety standards.
- (2) It is the legal responsibility of the repairer to ensure that these safety standards are maintained.
- (3) Repairs must be made in accordance with the relevant safety standards.
- (4) It is essential that safety critical components are replaced by approved parts.
- (5) If mains voltage selector is provided, check setting for local voltage.

1.3 INSTALLATION

1.3.1 HEAT DISSIPATION

If the heat dissipation vent behind this unit is blocked, cooling efficiency may deteriorate and temperature inside the unit will rise. The temperature sensor that protects the unit will be activated when internal temperature exceeds the pre-determined level and power will be turned off automatically. Therefore, please make sure pay attention not to block the heat dissipation vent as well as the ventilation outlet behind the unit and ensure that there is room for ventilation around it.

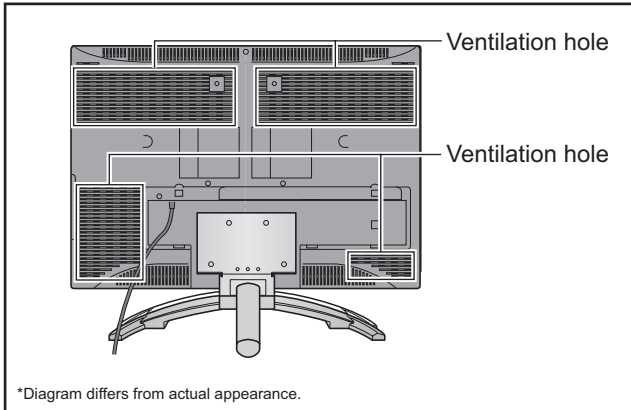

1.3.2 INSTALLATION REQUIREMENTS

Ensure that the minimal distance is maintained, as specified below, between the unit with and the surrounding walls, as well as the floor etc. Install the unit on stable flooring or stands. Take precautionary measures to prevent the unit from tipping in order to protect against accidents and earthquakes.

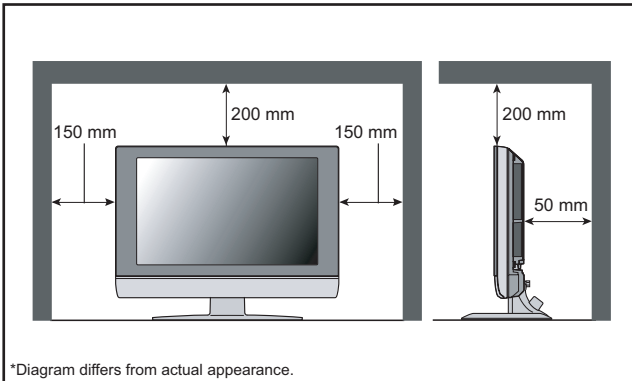

1.3.3 INSTALLATION REQUIREMENTS

To ensure safety in an emergency such as an earthquake, and to prevent accidents, ensure that measures are taken to prevent the TV dropping or falling over.

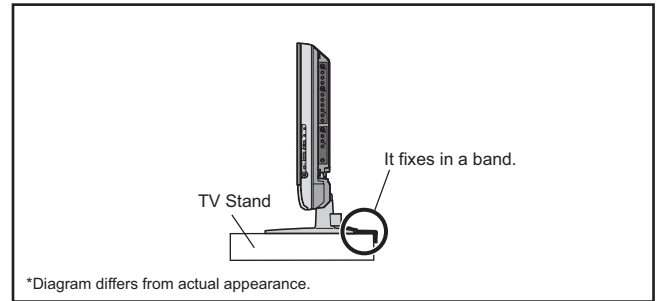

1.3.4 NOTES ON HANDLING

(1) WHEN TAKING UNIT OUT OF A PACKING CASE

When taking the unit out of a packing case, do not grasp the upper part of the unit. If you take the unit out while grasping the upper part, the LCD PANEL may be damaged because of a pressure. Instead of grasping the upper part, put your hands on the lower backside or sides of the unit.

(2) AS FOR PRESSING OR TOUCHING A SPEAKER

Be careful not to press the opening of the speaker in the lower part of the unit and around them since the decorative sheet on the surface of the openings may be deformed.

1.4 HANDLING LCD PANEL

1.4.1 PRECAUTIONS FOR TRANSPORTATION

When transporting the unit, pressure exerted on the internal LCD panel due to improper handling (such as tossing and dropping) may cause damages even when the unit is carefully packed. To prevent accidents from occurring during transportation, pay careful attention before delivery, such as through explaining the handling instructions to transporters.

Ensure that the following requirements are met during transportation, as the LCD panel of this unit is made of glass and therefore fragile:

- (1) **USE A SPECIAL PACKING CASE FOR THE LCD PANEL**
When transporting the LCD panel of the unit, use a special packing case (packing materials). A special packing case is used when a LCD panel is supplied as a service spare part.
- (2) **ATTACH PROTECTION SHEET TO THE FRONT**
Since the front (display part) of the panel is vulnerable, attach the protection sheet to the front of the LCD panel before transportation. Protection sheet is used when a LCD panel is supplied as a service spare part.
- (3) **AVOID VIBRATIONS AND IMPACTS**
The unit may be broken if it is toppled sideways even when properly packed. Continuous vibration may shift the gap of the panel, and the unit may not be able to display images properly. Ensure that the unit is carried by at least 2 persons and pay careful attention not to exert any vibration or impact on it.
- (4) **DO NOT PLACE EQUIPMENT HORIZONTALLY**
Ensure that it is placed upright and not horizontally during transportation and storage as the LCD panel is very vulnerable to lateral impacts and may break. During transportation, ensure that the unit is loaded along the traveling direction of the vehicle, and avoid stacking them on one another. For storage, ensure that they are stacked in 2 layers or less even when placed upright.

1.4.2 OPTICAL FILTER (ON THE FRONT OF THE LCD PANEL)

- (1) Avoid placing the unit under direct sunlight over a prolonged period of time. This may cause the optical filter to deteriorate in quality and COLOUR.
- (2) Clean the filter surface by wiping it softly and lightly with a soft and lightly fuzz cloth (such as outing flannel).
- (3) Do not use solvents such as benzene or thinner to wipe the filter surface. This may cause the filter to deteriorate in quality or the coating on the surface to come off. When cleaning the filter, usually use the neutral detergent diluted with water. When cleaning the dirty filter, use water-diluted ethanol.
- (4) Since the filter surface is fragile, do not scratch or hit it with hard materials. Be careful enough not to touch the front surface, especially when taking the unit out of the packing case or during transportation.

1.4.3 PRECAUTIONS FOR REPLACEMENT OF EXTERIOR PARTS

Take note of the following when replacing exterior parts (REAR COVER, FRONT PANEL, etc.):

- (1) Do not exert pressure on the front of the LCD panel (filter surface). It may cause irregular COLOUR.
- (2) Pay careful attention not to scratch or stain the front of the LCD panel (filter surface) with hands.
- (3) When replacing exterior parts, the front (LCD panel) should be placed facing downward. Place a mat, etc. underneath to avoid causing scratches to the front (filter surface).

SECTION 2

SPECIFIC SERVICE INSTRUCTIONS

2.1 FEATURES

T-V LINK

When you have a T-V LINK compatible VCR connected to the EXT-2 Terminal on the TV, it is easier to set up the VCR and to view videos.

PICTURE MODE

This function can adjust the picture settings automatically.

ZOOM

This function can change the screen size according to the picture aspect ratio.

DIGITAL VNR

This function cuts down the amount of noise in the original picture.

2.2 MAIN DIFFERENCE LIST

Item	LT-26A61BJ	LT-26A61BU	LT-26A61BU/C	LT-26A61SJ	LT-26A61SU	LT-26A61SU/C
PAINT COLOUR	BLACK	BLACK	BLACK	SILVER	SILVER	SILVER
LCD PANLEL UNIT	QLD0408-001-JUK	←	QLD0370-002-JUK	←	←	QLD0408-001-JUK
MAIN PWB	QAL0823-001	←	QAL0822-001	←	←	QAL0823-001

Item	LT-32A61BJ	LT-32A61BU	LT-32A61BU/C	LT-32A61SJ	LT-32A61SU	LT-32A61SU/C
PAINT COLOUR	BLACK	BLACK	BLACK	SILVER	SILVER	SILVER
LCD PANLEL UNIT	QLD0409-001-JUK	←	QLD0371-001-JUK	←	←	QLD0409-001-JUK
MAIN PWB	QAL0825-001	←	QAL0824-001	←	←	QAL0825-001

2.3 21-PIN EURO CONNECTOR (SCART) : EXT-1 / EXT-2

Pin No.	Signal designation	Matching value	EXT-1	EXT-2
1	AUDIO R output	500mV(rms) (Nominal), Low impedance	Used (TV OUT)	Used (LINE OUT)
2	AUDIO R input	500mV(rms) (Nominal), High impedance	Used (R1)	Used (R2)
3	AUDIO L output	500mV(rms) (Nominal), Low impedance	Used (TV OUT)	Used (LINE OUT)
4	AUDIO GND		Used	Used
5	GND (B)		Used	Used
6	AUDIO L input	500mV(rms) (Nominal), High impedance	Used (L1)	Used (L2)
7	B input	700mV _(B-W) , 75Ω	Used	Used
8	FUNCTION SW (SLOW SW)	Low : 0V-3V High : 8V-12V, High impedance	Used	Used
9	GND (G)		Used	Used
10	SCL / T-V LINK		Not used	Used (SCL2 / TV-LINK)
11	G input	700mV _(B-W) , 75Ω	Used	Used
12	SDA		Not used	Used (SDA2)
13	GND (R)		Used	Used
14	GND (YS)		Used	Not used
15	R / C input	R : 700mV _(B-W) , 75Ω C : 300mV _(P-P) , 75Ω	Used (R)	Used (C2/R)
16	Ys input (FAST SW)	Low : 0V-0.4V, High : 1V-3V, 75Ω	Used	Used
17	GND (VIDEO output)		Used	Used
18	GND (VIDEO input)		Used	Used
19	VIDEO output	1V _(P-P) (Negative sync), 75Ω	Used (TV OUT)	Used (LINE OUT)
20	VIDEO / Y input	1V _(P-P) (Negative sync), 75Ω	Used	Used
21	COMMON GND		Used	Used

(P-P= Peak to Peak, B-W= Blanking to white peak)

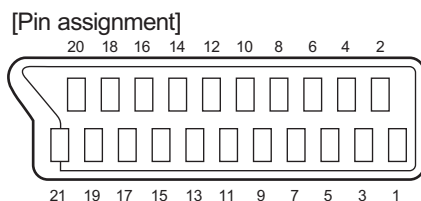

2.4 HOW TO IDENTIFY MODELS

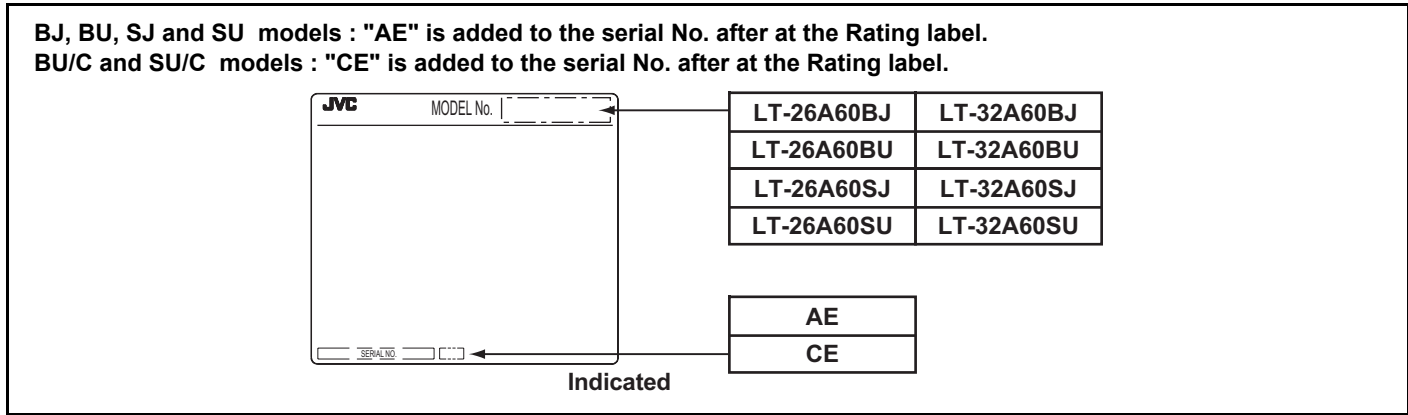

2.5 TECHNICAL INFORMATION

2.5.1 LCD PANEL

This unit uses the flat type panel LCD (Liquid Crystal Display) panel that occupies as little space as possible, instead of the conventional CRT (Cathode Ray Tube), as a display unit.

Since the unit has the two polarizing filter that are at right angles to each other, the unit adopts "normally black" mode, where light does not pass through the polarizing filter and the screen is black when no voltage is applied to the liquid crystals.

2.5.1.1 SPECIFICATIONS

The following table shows the specifications of this unit.

Item	Specifications			
	26V-TYPE LCD PANEL UNIT		32V-TYPE LCD PANEL UNIT	
	QLD0370-002-JUK	QLD0408-001-JUK	QLD0371-001-JUK	QLD0409-001-JUK
Maximum dimensions (W×H×D)	626 mm × 373 mm × 52 mm	626 mm × 373 mm × 47.5 mm	760 mm × 450 mm × 50 mm	760 mm × 450 mm × 45 mm
Weight	4.7 kg	4.2 kg	7.0 kg	7.2 kg
Effective screen size	Diagonal: 660 mm (H: 576 mm × V: 324 mm)		Diagonal: 800 mm (H: 697 mm × V: 392 mm)	
Aspect ratio	16 : 9			
Drive device / system	a-Si-TFT active matrix system			
Resolution	Horizontally 1366 × Vertically 768 × RGB < W-XGA > 3147264 dots in total			
Pixel pitch (pixel size)	Horizontally: 0.4215 mm, Vertically: 0.4215mm		Horizontally: 0.51075 mm, Vertically: 0.51075mm	
Displayed colour	16777216 colours 256 colours for R G and B			
Brightness	500cd/m ²			
Contrast ratio	1000 : 1	800 : 1	1000 : 1	800 : 1
Response time	less than 22 ms	less than 35 ms	less than 22 ms	less than 20 ms
View angle (Horizontally)	178°	170°		
View angle (Vertically)	178°	170°		
Surface polarizer	Anti-Glare type Low reflective coat			
Colour filter	Vertical stripe			
Backlight	U-type Cold cathode fluorescent lamp × 8		Direct-type Cold cathode fluorescent lamp ×16	
Power supply voltage in LCD	6.5 V	5 V	6.5 V	5 V
Power supply voltage in inverter	24 V			
Panel interface system	LVDS (Low Voltage Differential Signaling)			

2.5.1.2 PIXEL FAULT

There are three pixel faults - bright fault , dark fault and flicker fault - that are respectively defined as follows.

■ BRIGHT FAULT

In this pixel fault, a cell that should not light originally is lighting on and off.

For checking this pixel fault, input ALL BLACK SCREEN and find out the cell that is lighting on and off.

■ DARK FAULT

In this pixel fault, a cell that should light originally is not lighting or lighting with the brightness twice as brighter as originally lighting.

For checking this pixel fault, input 100% of each R/G/B colour and find out the cell that is not lighting.

■ FLICKER FAULT

In the pixel fault, a cell that should light originally or not light originally is flashing on and off.

For checking this pixel fault, input ALL BLACK SCREEN signal or 100% of each RGB colour and find out the cell that is flashing on and off.

2.5.2 MAIN CPU PIN FUNCTION [U302 : MAIN PWB]

Pin	Pin name	I/O	Function	Pin	Pin name	I/O	Function
1	D1	I/O	Program ROM data for CPU	51	NC2	-	Not used
2	D4	I/O	Program ROM data for CPU	52	XTAL2	O	6MHz for system clock
3	D2	I/O	Program ROM data for CPU	53	XTAL1	I	6MHz for system clock
4	D3	I/O	Program ROM data for CPU	54	NC3	-	Not used
5	XROM	O	This pin must be pulled low to access external ROM.	55	VSSA	-	GND
6	VDD 2.5	I	2.5V	56	VDDA 2.5	I	2.5V
7	VSS	-	GND	57	R	O	R for teletext
8	VDD 3.5	I	3.5V	58	G	O	G for teletext
9	P0.0	I/O	Address/Data for scaler IC	59	B	O	B for teletext
10	P0.1	I/O	Address/Data for scaler IC	60	BLANK/COR	O	Ys for Teletext
11	P0.2	I/O	Address/Data for scaler IC	61	NC4	-	Not used
12	P0.3	I/O	Address/Data for scaler IC	62	P1.7	O	Reset for Scaler IC [H=Reset]
13	P0.4	-	Not used	63	NC5	-	Not used
14	P0.5	O	Address latch Enable	64	WR	O	Write for memory
15	P0.6	-	Not used	65	RD	O	Read for memory
16	P0.7	-	Not used	66	NC6		Not used
17	ENE	-	Not used	67	A19	O	Program ROM address for CPU
18	STOP	-	Not used	68	A18	O	Program ROM address for CPU
19	OCF	-	Not used	69	A16	O	Program ROM address for CPU
20	EXTIF	-	Not used	70	A17	O	Program ROM address for CPU
21	CVBS	I	Video for teletext	71	A15	O	Program ROM address for CPU
22	VDDA 2.5	I	2.5V	72	FL_PGM	-	Test purpose
23	VSSA	-	GND	73	VDD 2.5	I	2.5V
24	P2.0	I	Scart2 ID [H=Detect]	74	VSS	-	GND
25	P2.1	I	key scan data 1	75	VDD 3.3	I	3.3V
26	P2.2	I	key scan data 2	76	A14	O	Program ROM address for CPU
27	P2.3	I	Scaet1 ID [H=Detect]	77	A12	O	Program ROM address for CPU
28	NC1	-	Not used	78	A13	O	Program ROM address for CPU
29	HS/SSC	I	Horizontal sync	79	A7	O	Program ROM address for CPU
30	VS	I	Vertical sync	80	FL_RST	-	Test purpose
31	P3.0	O	Data Read for Scaler IC	81	A8	O	Program ROM address for CPU
32	P3.1	O	Comunication for adjustment [H=TXD]	82	A6	O	Program ROM address for CPU
33	P3.2	I	TV-Link in	83	A9	O	Program ROM address for CPU
34	P3.3	I	Remote control	84	A5	O	Program ROM address for CPU
35	P3.4	I/O	I2C bus Data(for EEPROM)	85	A11	O	Program ROM address for CPU
36	P3.5	O	I2C bus Clock(for EEPROM)	86	A4	O	Program ROM address for CPU
37	P3.6	O	Data Write for Scaler IC	87	ALE	O	Address Latch Enable
38	P3.7	I	Comunication for adjustment [H=RXD]	88	PSEN	O	Program Store Enable
39	VSS	-	GND	89	A3	O	Program ROM address for CPU
40	VDD 3.3	I	3.3V	90	A10	O	Program ROM address for CPU
41	P1.0	O	RGB Select [L=SCART1, H=SCART2]	91	VSS	-	GND
42	P1.1	I	Headphone Ident [L=Detect]	92	VDD 3.3	I	3.3V
43	P1.2	I/O	I2C bus Data(for inter IC)	93	A2	O	Program ROM address for CPU
44	P1.3	O	I2C bus Clock(for inter IC)	94	A1	O	Program ROM address for CPU
45	P1.4	O	Reset for inter IC [L=Reset]	95	FL_CE	-	Test purpose
46	P1.5	I	PC Detect [L=Detect]	96	D7	I/O	Program ROM data for CPU
47	P1.6	O	Memory Pack I2C S/W [L=Detect]	97	A0	O	Program ROM address for CPU
48	P4.2	O	Main power control [L=ON, H=OFF]	98	D6	I/O	Program ROM data for CPU
49	P4.3	O	TV-Link out	99	D0	I/O	Program ROM data for CPU
50	RST	O	Reset [L=Reset]	100	D5	I/O	Program ROM data for CPU

SECTION 3

DISASSEMBLY

3.1 DISASSEMBLY PROCEDURE

CAUTION AT DISASSEMBLY:

- Make sure that the power cord is disconnected from the outlet.
- Pay special attention not to break or damage the parts.
- When removing each board, remove the connectors as required. Taking notes of the connecting points (connector numbers) makes service procedure manageable.
- Make sure that there is no bent or stain on the connectors before inserting, and firmly insert the connectors.

3.1.1 REMOVING THE STAND

- (1) Remove the JACK COVER.
- (2) Remove the STAND COVER by sliding it in the direction of an arrow.
- (3) Remove the 2 screws [A], then remove the STAND COVER.
- (4) Remove the 2 screws [B] and 2 screws [C], then remove the STAND.

3.1.2 REMOVING THE REAR COVER

- Remove the STAND.
 - (1) Remove the 8 screws [D], 1 screw [E] and 2 screws [F], then remove the REAR COVER.

3.1.3 REMOVING THE POWER PWB

- Remove the STAND.
- Remove the REAR COVER.
 - (1) Remove the 4 screws [G] and 1 screw [H], then remove the TERMINAL BASE.
 - (2) Remove the 8 screws [J], then remove the BACK BRACKET.
 - (3) Remove the 6 screws [K], then remove the POWER PWB SHIELD.
 - (4) Remove the 5 screws [L], then remove the POWER PWB.

3.1.4 REMOVING THE MAIN PWB

- Remove the STAND.
- Remove the REAR COVER.
- Remove the TERMINAL BASE.
- Remove the BACK BRACKET.
- Remove the POWER PWB SHIELD.
 - (1) Remove the 7 screws [M] and 2 screws [N], then remove the MAIN PWB SHIELD.
 - (2) Remove the 6 screws [P], then remove the MAIN PWB.

3.1.5 REMOVING THE KEY PWB

- Remove the STAND.
- Remove the REAR COVER.
 - (1) Remove the 2 screws [Q], then remove the KEY PWB.

3.1.6 REMOVING THE LED PWB

- Remove the STAND.
- Remove the REAR COVER.
 - (1) Remove the 2 screws [R], then remove the LED PWB.

3.1.7 REMOVING THE SPEAKER

- Remove the STAND.
- Remove the REAR COVER.
 - (1) Remove the 6 screws [S], then remove the SPEAKER (L/R).

CAUTION:

Please do not disassembly the SPEAKER. When the speaker is decomposed, the performance cannot be kept.

3.1.8 REMOVING THE LCD PANEL UNIT

- Remove the STAND.
- Remove the REAR COVER.
- Remove the TERMINAL BASE.
- Remove the BACK BRACKET.
 - (1) Remove the 6 screws [T], then remove the MAIN BASE.
 - (2) Remove the 6 screws [U], then remove the FRONT PANEL.
 - (3) Remove the 2 screws [V], then remove the TOP FRAME.
 - (4) Remove the 2 screws [W], then remove the BOTTOM FRAME.

NOTE:

- Pay special attention not to break or damage on the FRONT PANEL.
- The LCD PANEL UNIT is fixed to the FRONT PAMEL (at the back side)by using double-side adhesive tapes. To remove the LCD PANEL UNIT, remove the adhesive tape on the FRONT PANEL slowly.

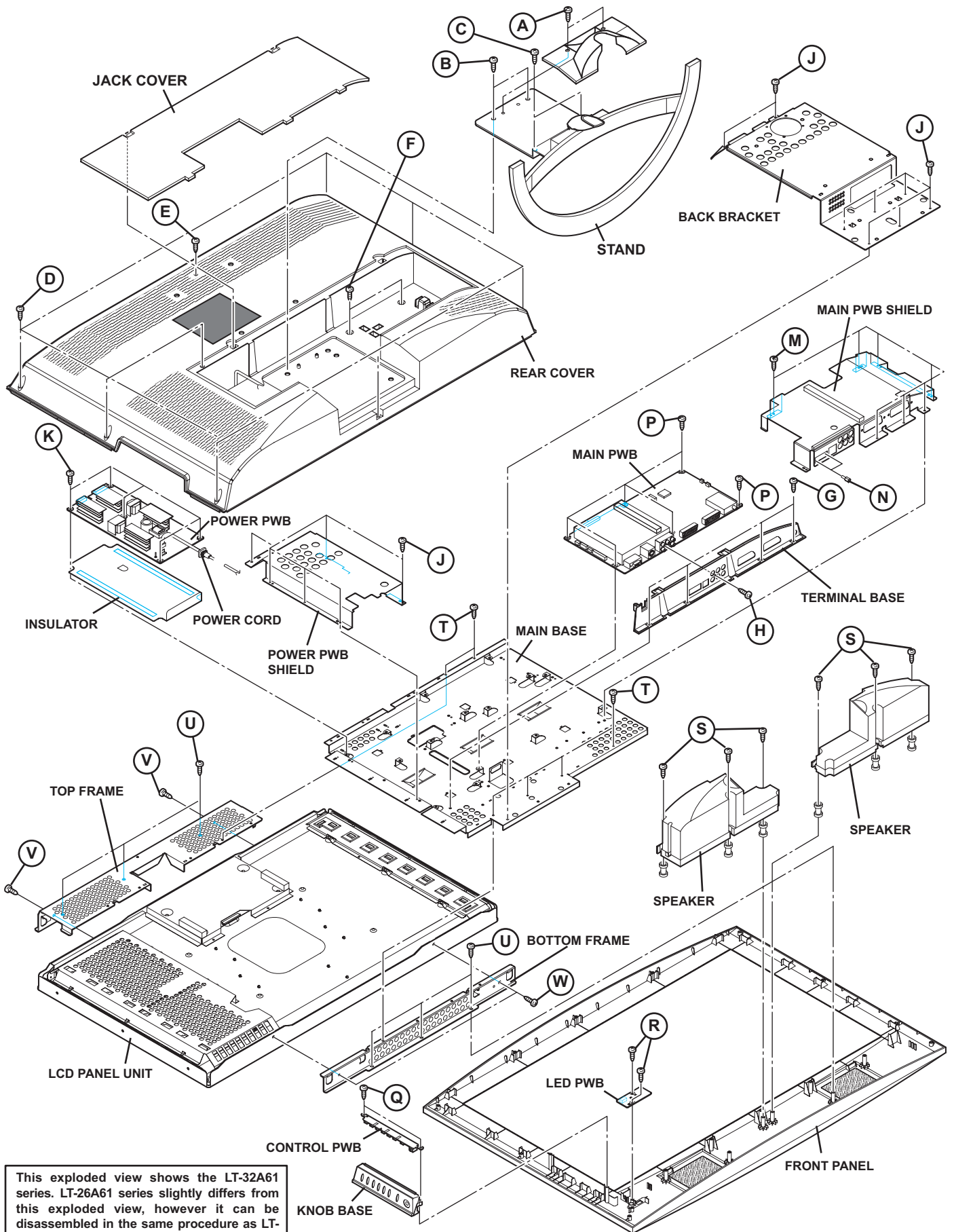

This exploded view shows the LT-32A61 series. LT-26A61 series slightly differs from this exploded view, however it can be disassembled in the same procedure as LT-26X506.

Fig.1

3.2 MEMORY IC REPLACEMENT

- This model uses the memory IC.
- This memory IC stores data for proper operation of the video and drive circuits.
- When replacing, be sure to use an IC containing this (initial value) data.

3.2.1 MEMORY IC REPLACEMENT PROCEDURE

1. Power off

Switch off the power and disconnect the power plug from the AC outlet.

2. Replace the memory IC

Be sure to use the memory IC written with the initial setting values.

3. Power on

Connect the power plug to the AC outlet and switch on the power.

4. Receiving channel setting

Refer to the OPERATING INSTRUCTIONS and set the receive channels (Channels Preset) as described.

5. User setting

Check the user setting items according to the given in page later. Where these do not agree, refer to the OPERATING INSTRUCTIONS and set the items as described.

6. SERVICE MODE setting

Verify what to set in the SERVICE MODE, and set whatever is necessary (Fig.1). Refer to the SERVICE ADJUSTMENT for setting.

3.2.2 SERVICE MODE SETTING

■SERVICE MODE SCREEN

NOTE:

As self check feature is not used in this TV, "2.SELF_CHECK" cannot be selected (screen display only).

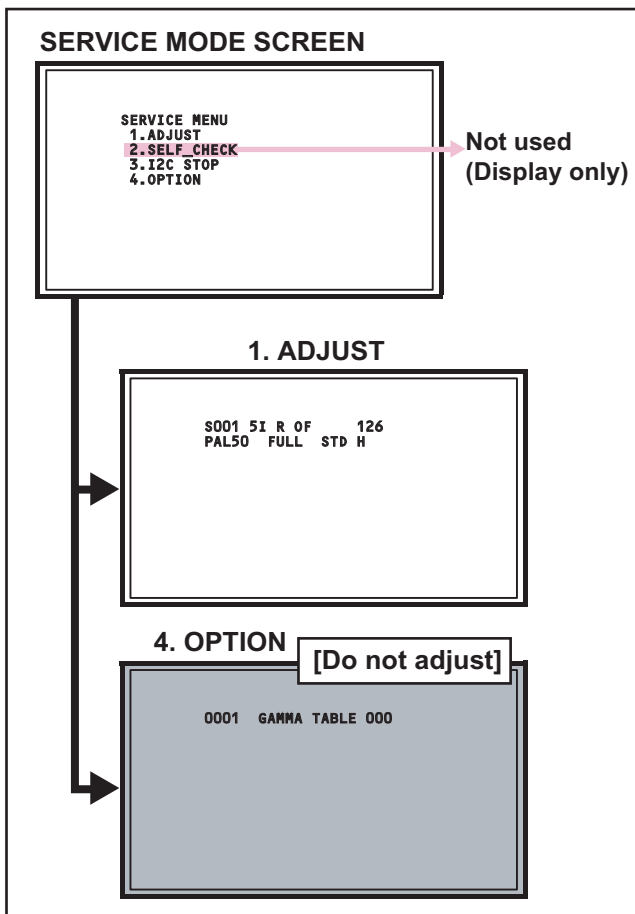

Fig.1

■SETTING ITEM

Setting items	Setting items	Settings	Item No.
1.ADJUST	Video system setting -1	Adjust	S001 - S043
	Video system setting -2	Fixed	M001 - M009
	Audio System Setting	Fixed	A001 - A003
	Video system setting -3	Fixed	D001 - D051
	Video system setting -4	Fixed	SD01 - SD15
1.OPTION	Option Setting	Fixed	DD07 - DD31
		Fixed	0001 - 0004

3.2.3 SETTINGS OF FACTORY SHIPMENT

3.2.3.1 BUTTON OPERATION

Setting item	Setting position
POWER	Off
CHANNEL	PR1
VOLUME	10
TV/AV	TV

3.2.3.3 REMOTE CONTROL MENU OPERATION

(1) PICTURE

Setting item	Setting position
PICTURE MODE	BRIGHT
COLOUR TEMP.	COOL
FEATURES	
DIGITAL VNR	AUTO (LOW)
COLOUR SYSTEM	TV Depends on PR/CH
	EXT AUTO
4:3 AUTO ASPECT	PANORAMIC

(2) SOUND

Setting item	Setting position
STEREO / I•II	Stereo sound
BASS	Centre
TREBLE	Centre
BALANCE	Centre
3D SOUND	OFF

3.2.3.2 REMOTE CONTROL DIRECT OPERATION

Setting item	Setting position
CHANNEL	PR1
VOLUME	10
ZOOM	PANORAMIC
3D SOUND	OFF

(4) FEATURES

Setting item	Setting position
SLEEP TIMER	OFF
CHILD LOCK	ID NO.0000, All CH off
APPEARANCE	TYPE D
BLUE BACK	ON
FAVOURITE SETTING	Reset

(5) SET UP

Setting item	Setting position
AUTO PROGRAM	TV channel automatically set
EDIT/MANUAL	PRESET CH only
LANGUAGE	ENGLISH
DECODER (EXT-2)	OFF
EXT SETTING	
S-IN	BLANK
ID	BLANK
DUBBING	EXT-1 → EXT-2

3.3 REPLACEMENT OF CHIP COMPONENT

3.3.1 CAUTIONS

- (1) Avoid heating for more than 3 seconds.
- (2) Do not rub the electrodes and the resist parts of the pattern.
- (3) When removing a chip part, melt the solder adequately.
- (4) Do not reuse a chip part after removing it.

3.3.2 SOLDERING IRON

- (1) Use a high insulation soldering iron with a thin pointed end of it.
- (2) A 30w soldering iron is recommended for easily removing parts.

3.3.3 REPLACEMENT STEPS

1. How to remove Chip parts

[Resistors, capacitors, etc.]

- (1) As shown in the figure, push the part with tweezers and alternately melt the solder at each end.

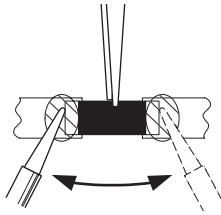

- (2) Shift with the tweezers and remove the chip part.

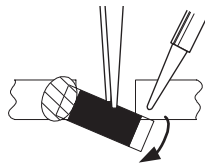

[Transistors, diodes, variable resistors, etc.]

- (1) Apply extra solder to each lead.



- (2) As shown in the figure, push the part with tweezers and alternately melt the solder at each lead. Shift and remove the chip part.

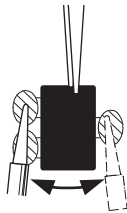

NOTE :

After removing the part, remove remaining solder from the pattern.

2. How to install Chip parts

[Resistors, capacitors, etc.]

- (1) Apply solder to the pattern as indicated in the figure.

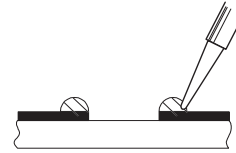

- (2) Grasp the chip part with tweezers and place it on the solder. Then heat and melt the solder at both ends of the chip part.

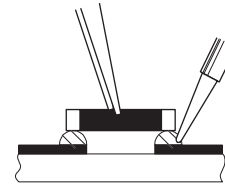

[Transistors, diodes, variable resistors, etc.]

- (1) Apply solder to the pattern as indicated in the figure.
- (2) Grasp the chip part with tweezers and place it on the solder.
- (3) First solder lead **A** as indicated in the figure.

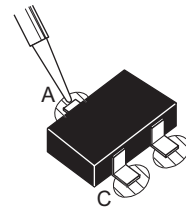

- (4) Then solder leads **B** and **C**.

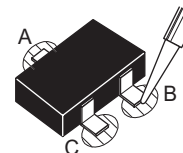

SECTION 4 ADJUSTMENT

4.1 ADJUSTMENT PREPARATION

- (1) The adjustment using the REMOTE CONTROL UNIT is made on the basis of the initial setting values. The setting values which adjust the screen to the optimum condition can be different from the initial setting values.
- (2) Make sure that connection is correctly made AC to AC power source.
- (3) Turn on the power of the TV and measuring instruments for warming up for at least 30 minutes before starting adjustments.
- (4) If the receive or input signal is not specified, use the most appropriate signal for adjustment.
- (5) Never touch the parts (such as variable resistors, transformers and condensers) not shown in the adjustment items of this service adjustment.

4.5 BASIC OPERATION OF SERVICE MODE

4.5.1 HOW TO ENTER THE SERVICE MODE

- (1) Press [INFORMATION] key and [MUTING] key on the remote control unit simultaneously to enter the SERVICE MODE SCREEN. (Fig.1)

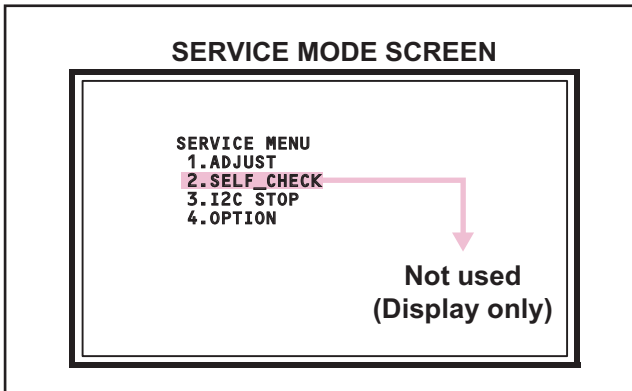

Fig.1

NOTE:

- As self check feature is not used in this TV, "2.SELF_CHECK" cannot be selected (screen display only).
- Before entering the SERVICE MODE, confirm that the setting of VCR/TV/DVD switch is at the "TV" side. If the switches have not been properly set, you cannot enter the SERVICE MODE.

4.5.2 HOW TO EXIT THE SERVICE MODE

Press the [MENU] key to exit the Service mode.

4.2 PRESET SETTING BEFORE ADJUSTMENTS

Unless otherwise specified in the adjustment items, preset the following functions with the REMOTE CONTROL UNIT.

Setting item	Settings position
PICTURE MODE	STANDARD
PICTURE adjustments	Centre
COLOUR TEMP.	NORMAL

4.3 MEASURING INSTRUMENT AND FIXTURES

- Signal generator (Pattern generator)[PAL]
- Remote control unit

4.4 ADJUSTMENT ITEMS

4.5.3 CHANGE AND MEMORY OF SETTING VALUE

SELECTION OF SETTING ITEM

- [FUNCTION ▲/▼] key.
For scrolling up / down the setting items.

CHANGE OF SETTING VALUE (DATA)

- [FUNCTION ◀/▶] key.
For scrolling up / down the setting values.

MEMORY OF SETTING VALUE (DATA)

- Changed setting value is memorized by pressing [MUTING] key.

4.5.4 SERVICE MODE SELECT KEY LOCATION

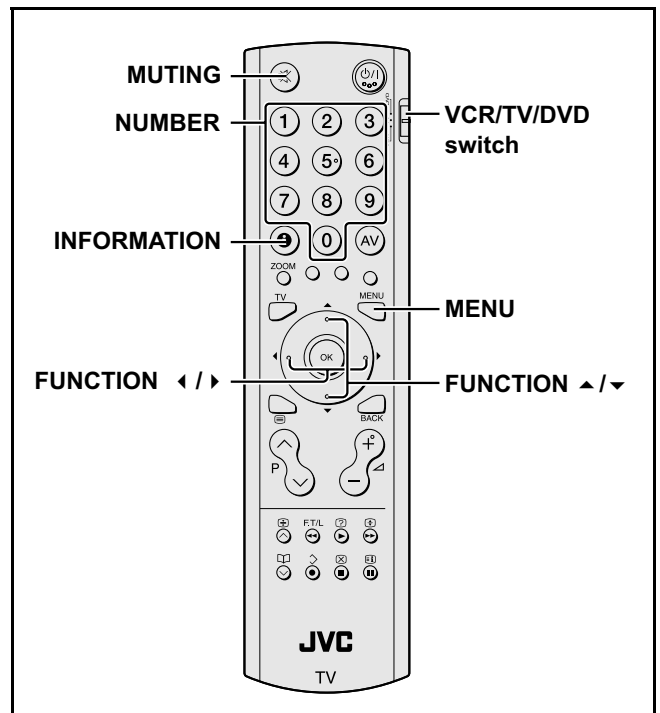

4.5.5 ADJUSTMENT MODE

This mode is used to adjust the VIDEO CIRCUIT.

4.5.5.1 HOW TO ENTER THE ADJUSTMENT MODE

When the SERVICE MENU SCREEN of SERVICE MODE is displayed, press **[1]** key to enter the ADJUSTMENT MODE (Fig.2).

NOTE:

- When a number key other than the **[1]** key is pressed in the SERVICE MODE SCREEN, the other relevant screen may be displayed.
This is not used in the adjustment procedure. Press the **[MENU]** key to return to the SERVICE MODE SCREEN.

4.5.5.2 DESCRIPTION OF STATUS DISPLAY

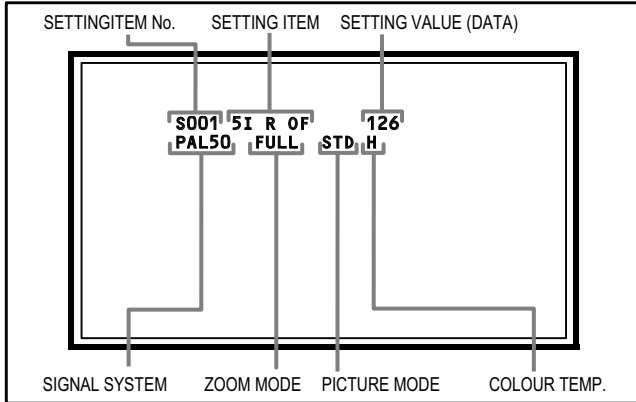

(1) SIGNAL SYSTEM

The signal displayed on the screen is displayed.

- PAL50 : PAL50Hz (Composite / S-video)
- PAL60 : PAL60Hz (Composite / S-video)
- SECAM : SECAM
- NTSC3 : NTSC3.58
- NTSC4 : NTSC4.43
- 525I : 525i (Component)
- 525P : 525p
- 625I : 625i (Component)
- 625P : 625p
- 750P6 : 750p 60Hz
- PCVGA : PC (VGA)
- PCXGA : PC (XGA)

(2) ZOOM MODE

State of the screen mode is displayed.

NOTE:

In ADJUSTMENT MODE, the screen mode can be set only to **"FULL"**. When it is entered to ADJUSTMENT MODE, it is automatically changed to **"FULL"**, even if the setting is in other screen mode.

(3) PICTURE MODE

State of the picture mode is displayed.

NOTE:

In ADJUSTMENT MODE, the picture mode can be set only to **"STANDARD"**. When it is entered to ADJUSTMENT MODE, it is automatically changed to **"STANDARD"**, even if the setting is in other picture mode.

(4) WHITE BALANCE

State of the colour temperature is displayed.

NOTE:

In ADJUSTMENT MODE, the colour temperature can be set only to **"NORMAL"**. When it is entered to ADJUSTMENT MODE, it is automatically changed to **"NORMAL"**, even if the setting is in other colour temperature.

(5) SETTING ITEM NAME

Setting item name are displayed. The setting item numbers to be displayed are listed below.

Item No.	Setting item
S001 - S043	Video system setting -1
M001 - M009	Video system setting -2
A001 - A003	Audio System Setting
D001 - D051	Video system setting -3
SD01 - SD15	Video system setting -4
DD07 - DD31	Video system setting -5

(6) SETTING ITEM NO.

Setting item numbers are displayed. For the setting item names to be displayed, refer to "INITIAL SETTING VALUES IN THE SERVICE MODE".

(7) SETTING VALUE (DATA)

The SETTING VALUE is displayed.

4.5.6 OPTION MODE [Do not adjust]

Display of optin data setting.

4.5.6.1 DESCRIPTION OF STATUS DISPLAY

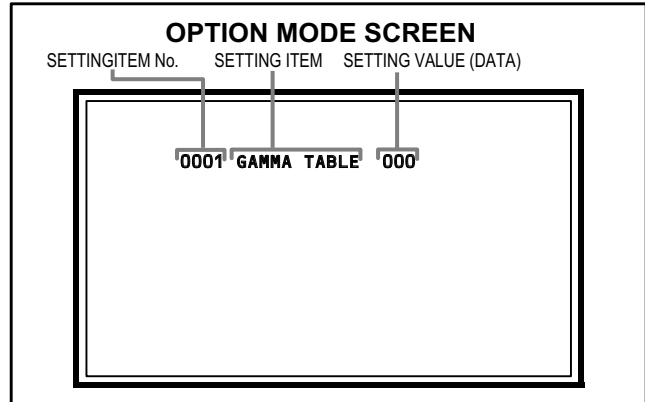

(1) SETTING ITEM NAME

Setting item name are displayed. The setting item numbers to be displayed are listed below.

Item No.	Setting item
0001 - 0004	optin data setting [Do not adjust]

(2) SETTING ITEM NO.

Setting item numbers are displayed. For the setting item names to be displayed, refer to "INITIAL SETTING VALUES IN THE SERVICE MODE".

(3) SETTING VALUE (DATA)

The SETTING VALUE is displayed.

4.6 INITIAL SETTING VALUES IN THE SERVICE MODE

- Perform fine-tuning based on the "initial values" using the remote control when in the Service mode.
- The "initial values" serve only as an indication rough standard and therefore the values with which optimal display can be achieved may be different from the default values. But, don't change the values that are not written in "ADJUSTMENT PROCEDURE". They are fixed values.

4.6.1 ADJUSTMENT MODE

4.6.1.1 VIDEO SYSTEM SETTING -1

Item No.	Item name	Variable range	Setting value
S001	5I R OF	000 - 255	127
S002	5I G OF	000 - 255	127
S003	5I B OF	000 - 255	126
S004	5P R OF	000 - 255	127
S005	5P G OF	000 - 255	127
S006	5P B OF	000 - 255	126
S007	HD75 R OF	000 - 255	127
S008	HD75 G OF	000 - 255	127
S009	HD75 B OF	000 - 255	126
S010	HD25 R OF	000 - 255	127
S011	HD25 G OF	000 - 255	127
S012	HD25 B OF	000 - 255	126
S013	R DRIVE	000 - 255	150
S014	G DRIVE	000 - 255	126
S015	B DRIVE	000 - 255	117
S016	HD R DR	-32 - 31	00
S017	HD G DR	-32 - 31	00
S018	HD B DR	-32 - 31	00
S019	CL R DR	-32 - 31	01
S020	CL G DR	-32 - 31	01
S021	CL B DR	-32 - 31	08
S022	WM R DR	-32 - 31	00
S023	WM G DR	-32 - 31	-7
S024	WM B DR	-32 - 31	-16
S025	HD CL R DR	-32 - 31	01
S026	HD CL G DR	-32 - 31	00
S027	HD CL B DR	-32 - 31	00
S028	HD WM R DR	-32 - 31	00
S029	HD WM G DR	-32 - 31	-2
S030	HD WM B DR	-32 - 31	-1
S031	PC R OF	000 - 255	115
S032	PC G OF	000 - 255	127
S033	PC B OF	000 - 255	127
S034	PC R DR	-32 - 31	-23
S035	PC G DR	-32 - 31	00
S036	PC B DR	-32 - 31	00
S037	PC CL R DR	-32 - 31	00
S038	PC CL G DR	-32 - 31	03
S039	PC CL B DR	-32 - 31	09
S040	PC WM R DR	-32 - 31	00
S041	PC WM G DR	-32 - 31	-6
S042	PC WM B DR	-32 - 31	-15
S043	PC AUTO WB	0 - 1	0

4.6.1.2 VIDEO SYSTEM SETTING -2 (Fixed values)

Item No.	Item name	Variable range	Setting value
M001	MV CON	000 - 255	105
M002	MV SHA	00 - 63	09
M003	MV COL	000 - 255	147
M004	MV TIN	000 - 255	051
M005	AGC GAIN	000 - 255	120
M006	ERR Limit	000 - 127	022
M007	PC R GAIN	000 - 255	099
M008	PC G GAIN	000 - 255	099
M009	PC B GAIN	000 - 255	101

4.6.1.3 AUDIO SYSTEM SETTING (Fixed values)

Item No.	Item name	Variable range	Setting value
A001	S BASS	00 - 16	8
A002	S TRE	00 - 16	8
A003	3D LEVEL	00 - 63	31

4.6.1.4 VIDEO SYSTEM SETTING -3 (Fixed values)

Item No.	Item name	Variable range	Setting value
D001	S CON	00 - 63	20
D002	S BRI	00 - 63	47
D003	S SHA	00 - 15	0
D004	S COL	00 - 63	35
D005	S TIN	00 - 63	32
D006	RGB S COL	000 - 127	085
D007	5I S CON	00 - 63	25
D008	5I S BRI	00 - 63	35
D009	5I S SHA	00 - 63	46
D010	5I S COL	00 - 63	53
D011	5I S TIN	00 - 63	35
D012	5P S CON	00 - 63	24
D013	5P S BRI	00 - 63	35
D014	5P S SHA	00 - 63	18
D015	5P S COL	00 - 63	51
D016	5P S TIN	00 - 63	35
D017	HD75 S CON	00 - 63	29
D018	HD75 S BRI	00 - 63	32
D019	HD75 S SHA	00 - 63	30
D020	HD75 S COL	00 - 63	52
D021	HD75 S TIN	00 - 63	34
D022	HD25 S CON	00 - 63	29
D023	HD25 S BRI	00 - 63	32
D024	HD25 S SHA	00 - 63	30
D025	HD25 S COL	00 - 63	52
D026	HD25 S TIN	00 - 63	34

Item No.	Item name	Variable range	Setting value
D027	PC S CON	00 - 63	25
D028	PC S BRI	00 - 63	35
D029	TXT S CON	000 - 127	024
D030	TXT S BRI	000 - 127	016
D031	RGB S CON	000 - 127	040
D032	RGB S BRI	000 - 127	062
D033	STD BRI1	00 - 31	025
D034	STD CON	00 - 31	016
D035	STD BRI2	00 - 31	16
D036	STD SHA	00 - 31	16
D037	STD COL	00 - 31	16
D038	STD TIN	00 - 31	16
D039	SFT BRI1	00 - 31	16
D040	SFT CON	00 - 31	16
D041	SFT BRI2	00 - 31	16
D042	SFT SHA	00 - 31	16
D043	SFT COL	00 - 31	16
D044	SFT TIN	00 - 31	16
D045	BRI BRI1	00 - 31	31
D046	BRI CON	00 - 31	21
D047	BRI BRI2	00 - 31	14
D048	BRI SHA	00 - 31	21
D049	BRI COL	00 - 31	16
D050	BRI TIN	00 - 31	16
D051	PWM	00 - 31	5

4.6.1.5 VIDEO SYSTEM SETTING -4 (Fixed values)

Item No.	Item name	Variable range	Setting value
SD01	5I R DR	00 - 63	30
SD02	5I G DR	00 - 63	26
SD03	5I B DR	00 - 63	30
SD04	5P R DR	00 - 63	30
SD05	5P G DR	00 - 63	26
SD06	5P B DR	00 - 63	30
SD07	HD75 R DR	00 - 63	30
SD08	HD75 G DR	00 - 63	26
SD09	HD75 B DR	00 - 63	30
SD10	HD25 R DR	00 - 63	30
SD11	HD25 G DR	00 - 63	26
SD12	HD25 B DR	00 - 63	30
SD13	PC R DR	00 - 63	5
SD14	PC G DR	00 - 63	5
SD15	PC B DR	00 - 63	5

4.6.1.6 VIDEO SYSTEM SETTING -5 (Fixed values)

Item No.	Item name	Variable range	Setting value
DD07	5I S CON	00 - 63	31
DD08	5I S BRI	00 - 63	10
DD09	5I S SHA	00 - 63	35
DD10	5I S COL	00 - 63	52
DD11	5I S TIN	00 - 63	32
DD12	5P S CON	00 - 63	31
DD13	5P S BRI	00 - 63	10
DD14	5P S SHA	00 - 63	30
DD15	5P S COL	00 - 63	52
DD16	5P S TIN	00 - 63	32
DD17	HD75 S CON	00 - 63	31
DD18	HD75 S BRI	00 - 63	10
DD19	HD75 S SHA	00 - 63	45
DD20	HD75 S COL	00 - 63	52
DD21	HD75 S TIN	00 - 63	32
DD22	HD25 S CON	00 - 63	31
DD23	HD25 S BRI	00 - 63	10
DD24	HD25 S SHA	00 - 63	45
DD25	HD25 S COL	00 - 63	52
DD26	HD25 S TIN	00 - 63	32
DD27	PC S CON	00 - 63	35
DD28	PC S BRI	00 - 63	0
DD29	PC S SHA	00 - 63	40
DD30	PC S COL	00 - 63	52
DD31	PC S TIN	00 - 63	32

4.6.2 OPTION MODE

4.6.3 OPTION SETTING (Fixed values)

Item No.	Item name	Variable range	Setting value
0001	GAMMA TABLE	000 - 005	001
0002	DIMMING	000 - 002	000
0003	HPD SW	000 - 001	000
0004	HPD DELAY	000 - 255	010
0005	DVI MCLK	000 - 255	090

4.7 ADJUSTMENT PROCEDURE

4.7.1 VIDEO CIRCUIT

Item	Measuring instrument	Test point	Adjustment part	Description																												
WHITE BALANCE (HIGHLIGHT)	Remote control unit		[1.ADJUST] S013: R DRIVE (Red drive) S015: G DRIVE (Green drive) S017: B DRIVE (Blue drive)	(1) Receive a PAL 75% all white signal. (2) Set PICTURE MODE to " STANDARD ". (3) Set ZOOM to " FULL ". (4) Set COLOUR TEMP. to " NORMAL ". (5) Select " 1.ADJUST " from the SERVICE MODE. (6) Set < S013 > (R DRIVE), < S015 > (G DRIVE) and < S017 > (B DRIVE) to setting values of left table. (7) Adjust to Keep one of < S030 > (Red drive), < S031 > (Green drive) or < S032 > (Blue drive) unchanged, then lower the other two so that the all-white screen is equally white throughout. NOTE: Set one or more of < S013 >, < S015 >, and < S017 > to setting values of left table. (8) Check that white balance is properly tracked from low light to high light. If the white balance tracking is deviated, adjust to correct it. (9) Press the [MUTING] key to memoirze the set value.																												
	Signal generator																															
26V-inch <table border="1" style="width: 100%;"> <thead> <tr> <th>Models</th> <th>Setting Value</th> </tr> </thead> <tbody> <tr><td>LT-26A61BJ</td><td>146</td></tr> <tr><td>LT-26A61BU</td><td>146</td></tr> <tr><td>LT-26A61BU/C</td><td>140</td></tr> <tr><td>LT-26A61SJ</td><td>140</td></tr> <tr><td>LT-26A61SU</td><td>140</td></tr> <tr><td>LT-26A61SU/C</td><td>146</td></tr> </tbody> </table> 32V-inch <table border="1" style="width: 100%;"> <thead> <tr> <th>Models</th> <th>Setting Value</th> </tr> </thead> <tbody> <tr><td>LT-32A61BJ</td><td>146</td></tr> <tr><td>LT-32A61BU</td><td>146</td></tr> <tr><td>LT-32A61BU/C</td><td>140</td></tr> <tr><td>LT-32A61SJ</td><td>150</td></tr> <tr><td>LT-32A61SU</td><td>150</td></tr> <tr><td>LT-32A61SU/C</td><td>146</td></tr> </tbody> </table>					Models	Setting Value	LT-26A61BJ	146	LT-26A61BU	146	LT-26A61BU/C	140	LT-26A61SJ	140	LT-26A61SU	140	LT-26A61SU/C	146	Models	Setting Value	LT-32A61BJ	146	LT-32A61BU	146	LT-32A61BU/C	140	LT-32A61SJ	150	LT-32A61SU	150	LT-32A61SU/C	146
Models	Setting Value																															
LT-26A61BJ	146																															
LT-26A61BU	146																															
LT-26A61BU/C	140																															
LT-26A61SJ	140																															
LT-26A61SU	140																															
LT-26A61SU/C	146																															
Models	Setting Value																															
LT-32A61BJ	146																															
LT-32A61BU	146																															
LT-32A61BU/C	140																															
LT-32A61SJ	150																															
LT-32A61SU	150																															
LT-32A61SU/C	146																															

SECTION 5 TROUBLESHOOTING

This service manual does not describe TROUBLESHOOTING.



JVC

Victor Company of Japan, Limited
Flat Panel Display Category 12, 3-chome, Moriya-cho, Kanagawa-ku, Yokohama-city, Kanagawa-prefecture, 221-8528, Japan

(No.YA369)



JVC

InteriArt

LT-32A61BJ

LT-32A61SJ

LT-26A61BJ

LT-26A61SJ

HD
ready

T-V LINK

WIDE LCD PANEL TV

INSTRUCTIONS



■ Warning

DO NOT cut off the mains plug from this equipment. If the plug fitted is not suitable for the power points in your home or the cable is too short to reach a power point, then obtain an appropriate safety approved extension lead or adaptor or consult your dealer.

If nonetheless the mains plug is cut off, remove the fuse and dispose of the plug immediately, to avoid a possible shock hazard by inadvertent connection to the mains supply.

If a new mains plug has to be fitted, then follow the instruction given below:

Important

Do not make any connection to the larger terminal which is marked with the letter E or by the safety earth symbol \perp or coloured green or green-and-yellow.

The wires in the mains lead on this product are coloured in accordance with the following code:

Blue: Neutral

Brown: Live

As these colours may not correspond with the coloured marking identifying the terminals in your plug proceed as follows:

The wire which is coloured blue must be connected to the terminal which is marked with the letter N or coloured black.

The wire which is coloured brown must be connected to the terminal which is marked with the letter L or coloured red.

When replacing the fuse, use only a correctly rated approved type and always re-fit the fuse cover.

■ If in doubt — consult a competent electrician.

How to replace the fuse

Open the fuse compartment with a blade screwdriver, and replace the fuse.

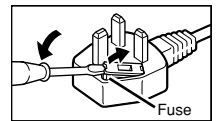

■ Guidelines for safe operation

This equipment has been designed and manufactured to comply with international safety standards. However, as with any electrical appliance, care must be taken to ensure optimal results and operational safety.

- Before attempting to use this equipment, read the operating instructions thoroughly.
- Ensure that all electrical connections (including the mains plug, extension leads, etc.) have been made in accordance with the manufacturer's instructions.
- If ever in doubt about the installation, operation or safety of this equipment, consult your dealer.
- Handle all glass panels or covers with care.
- Never operate this equipment if it appears damaged or operates abnormally. Turn the power off, disconnect the main power plug and consult your dealer.
- Never remove any affixed panels or covers. Doing so may result in electrical shock.
- Never leave this equipment operating unattended unless otherwise specifically stated that it is designed to do so or in standby mode. Only use the designated power switch to turn off the power and ensure that all potential users are instructed how to do so. Make special arrangements for infirm or handicapped persons.
- Never watch TV while operating a motor vehicle. It is illegal to watch TV while driving.
- Never listen to headphones at high volume. Doing so may damage your hearing.
- Never obstruct the ventilation of this equipment. Doing so may cause overheating and result in a malfunction or damage.
- Never use makeshift stands or attempt to affix legs with wood screws. When using a manufacturer's approved stand or legs, use only the fixtures provided and follow the installation instructions.
- Never allow this equipment to be exposed to rain or moisture.
- Never allow anyone, especially children, to insert anything into an opening in the case. Doing so may result in a fatal electrical shock.
- Never guess or take chances with electrical equipment of any kind. It is better to be safe than sorry.

Thank you for buying this JVC LCD flat television. To make sure you understand how to use your new TV, please read this manual thoroughly before you begin. ("LCD" stands for Liquid Crystal Display.)

WARNING: TO PREVENT FIRE OR SHOCK HAZARD, DO NOT EXPOSE THIS APPLIANCE TO RAIN OR MOISTURE.

WARNING

- The TV may fall causing injuries. Hold the bottom of the stand with your hand and tilt the TV up and down.
- Do not allow children to hang from the TV, place their elbows on the TV or lean against the TV. Doing so may cause the TV to fall over and lead to injuries.

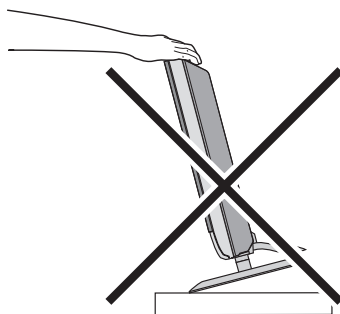

CAUTION

- The TV screen may be damaged if the TV is carried as shown in the diagram below. The TV should always be carried by two people.

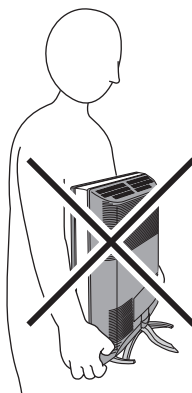

Pixel defects

LCDs use collections of fine points ("pixels") to display images. While there is no problem with more than 99.99% of these pixels, please understand that a very small number of pixels may not light, or may light all the time.

Distance recommendations

Avoid improper installation and never position the unit where good ventilation is impossible.

When installing this TV, distance recommendations must be maintained between the set and the wall, as well as inside a tightly enclosed area or piece of furniture. Keep to the minimum distance guidelines shown for safe operation.

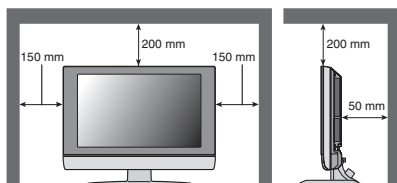

Failure to take the following precautions may cause damage to the television or remote control.

DO NOT block the TV's ventilation openings or holes.

(If the ventilation openings or holes are blocked by a newspaper or cloth, etc., the heat may not be able to get out.)

DO NOT place anything on top of the TV.

(such as cosmetics or medicines, flower vases, potted plants, cups, etc.)

DO NOT allow objects or liquid into the cabinet openings.

(If water or liquid is allowed to enter this equipment, fire or electric shock may be caused.)

DO NOT place any naked flame sources, such as lighted candles, on the TV.

DO NOT subject the TV to direct sunlight.

The surface of the TV screen is easily damaged. Be very careful with it when handling the TV. Should the TV screen become soiled, wipe it with a soft dry cloth. Never rub it forcefully. Never use any cleaner or detergent on it.

If there is a fault, unplug the unit and call a service technician. Do not attempt to repair it yourself or remove the rear cover.

■ **Cleaning the screen**

The screen is coated with a special thin film to reduce reflection. If this film is damaged, uneven colors, discoloration, scratches, and other problems that cannot be repaired may occur. Pay attention to the following when handling the screen.

- Do not use glue or adhesive tape on the screen.
- Do not write on the screen.
- Do not allow the screen to come in contact with any hard objects.
- Do not allow condensation to form on the screen.
- Do not use alcohol, thinner, benzene or other solvents on the screen.
- Do not rub the screen hard.

CAUTION:

- Operate only from the power source specified (AC 110 – 240 V, 50/60 Hz) on the unit.
 - Avoid damaging the AC plug and power cord.
 - When you are not using this unit for a long period of time, it is recommended that you disconnect the power cord from the main outlet.
-

CONTENTS

Setting up your TV	4	PICTURE menu	25
Installation	4	PICTURE MODE	25
Using the stand	4	BRIGHT-1	25
Removing the terminal cover	5	CONTRAST	25
Connecting the aerial and video cassette recorder (VCR)	6	BRIGHT-2	25
Connecting the power cord to the AC outlet	7	SHARP	25
Putting the batteries into the remote control	7	COLOUR	25
Initial settings	7	HUE	25
T-V LINK functions	10	COLOUR TEMP	25
TV buttons and functions	12	FEATURES	26
Turn the TV on from standby mode	12	SOUND menu	28
Choose a TV channel	12	STEREO / I • II	28
Watch images from external devices	12	BASS	28
Adjust the volume	13	TREBLE	28
Using the Menu	13	BALANCE	28
Remote control buttons and functions	14	3D SOUND	28
Turn the TV on or off from standby mode ...	14	FEATURES menu	29
Choose a TV channel and watch images from external devices	15	SLEEP TIMER	29
Adjust the volume	16	CHILD LOCK	29
Information function	16	APPEARANCE	30
ZOOM function	17	BLUE BACK	30
3D SOUND function	18	FAVOURITE SETTING	31
Return to TV channel instantly	18	SET UP menu	32
Favourite channel function	19	AUTO PROGRAM	32
Operating a JVC brand VCR or DVD player	20	EDIT/MANUAL	32
Teletext function	21	LANGUAGE	36
Basic operation	21	DECODER (EXT-2)	36
Using the List Mode	21	EXT SETTING	37
Hold	22	Additional preparation	40
Sub-page	22	Connecting external equipment	40
Reveal	22	CH/CC numbers	44
Size	22	Troubleshooting	46
Index	23	Cable management	49
Cancel	23	Specifications	Back Cover
Using the TV's menu	24		
Basic operation	24		

Setting up your TV

- When you install the TV on the wall, only use a JVC wall mounting unit (optional) which is designed for this TV.
- Make sure that the TV is installed on the wall by a skilled installer.

Installation

Cautions for installation

- Install the TV in a corner on a wall or on the floor so as to keep cords out of the way.
- The TV will generate a slight amount of heat during operation. Ensure that sufficient space is available around the TV to allow satisfactory cooling. See “Distance recommendations” on page 1.

Using the stand

This TV comes with a table top stand already attached.

This stand can be used to adjust the direction of the TV screen to the left or right.

■ Rotate the TV to the left and right:

While holding the bottom of the stand with one hand, use your other hand to hold the edge of the panel and slowly adjust the direction of the TV screen.

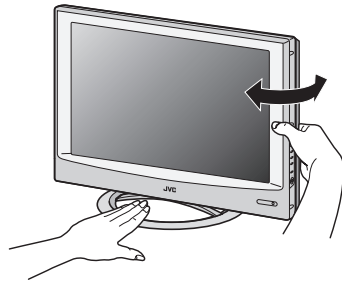

Removing the terminal cover

There are connection terminals behind the cover on the rear of the TV. Remove the cover before connecting an antenna or VCR.

Remove the cover by removing the hooks.
When replacing the cover, place the side of the cover against the TV and insert the hooks.

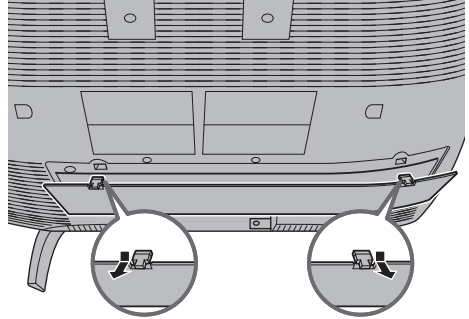

-
- Leave the cover off if they do not fit properly. Do not force to replace the cover. Doing so may cause damage to the connection cables and the cover.
-

Connecting the aerial and video cassette recorder (VCR)

- The connecting cables are not provided.
- For further details, refer to the manuals provided with the devices to be connected.

Caution

- Turn off all the equipment including the TV before connecting anything.

■ If you are connecting a VCR, follow (A) → (B) → (C) in the diagram opposite.

■ If you are not connecting a VCR, follow ①.

To use the T-V LINK functions, you must have a T-V LINK compatible VCR connected by a SCART cable (C) to the EXT-2 terminal on the TV. For details about T-V LINK functions, see “T-V LINK functions” on page 10.

- You can watch a video using the VCR without doing (C). For details, see your VCR instruction manual.
- To connect more equipment, please see “Connecting external equipment” on page 40.
- If you connect a decoder to a T-V LINK compatible VCR, set the DECODER (EXT-2) function to ON. For details, see “DECODER (EXT-2)” on page 36. Otherwise, you will not be able to watch scrambled channels.

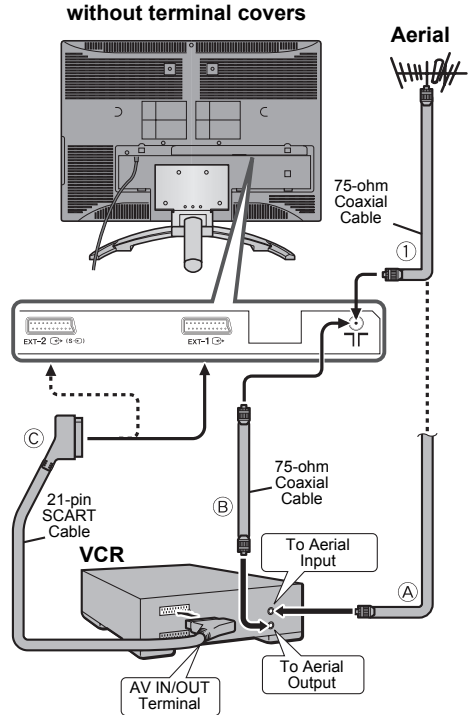

Connecting the power cord to the AC outlet

Insert the AC plug on the power cord from the TV into an AC outlet.

Caution

- Operate only from the power source specified (AC 110 – 240 V, 50/60 Hz) on the unit.
- Remove the AC plug from the outlet to completely disconnect the TV from the power supply.

Putting the batteries into the remote control

Use two AA/R6 dry cell batteries. Insert the batteries from the \ominus end, making sure the \oplus and \ominus polarities are correct.

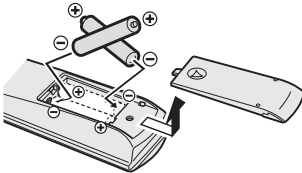

- Follow the warnings printed on the batteries.
- Battery life is about six months to one year, depending on how much you use the remote control.
- The batteries we supply are only for setting up and testing your TV, please replace them as soon as you need to.
- If the remote control does not work properly, replace the batteries.

Initial settings

When the TV is first turned on, it goes into the initial settings mode, and you will see the JVC logo. Follow the instructions on the screen display to make the initial settings.

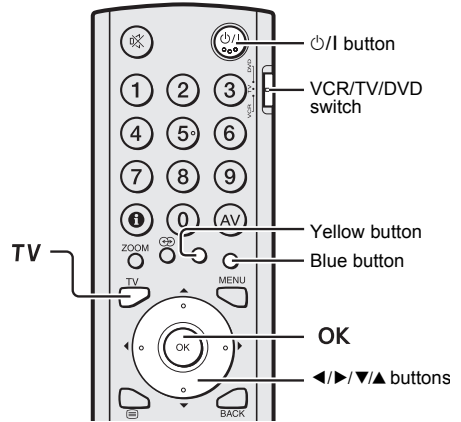

1 Make sure to set the VCR/TV/DVD switch on the remote control to the TV position

- You cannot turn the TV on when the VCR/TV/DVD switch is set to the VCR or DVD position.

2 Press the ⏻ button on the remote control

The TV turns on from standby mode and the JVC logo is displayed.

- Check that the AC plug on the power cord from the TV is connected to AC outlet.

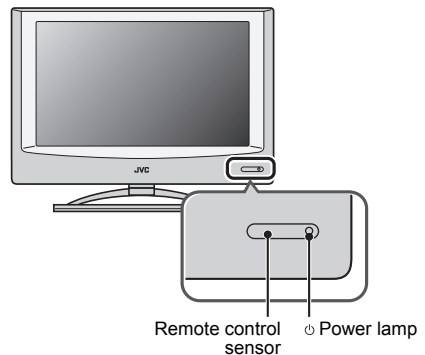

- If the JVC logo does not appear this is because your TV has already been turned on for the first time: use the “LANGUAGE” and “AUTO PROGRAM” functions to make the initial settings. For details, see “SET UP menu” on page 32.

3 Press the OK button

The LANGUAGE menu appears.

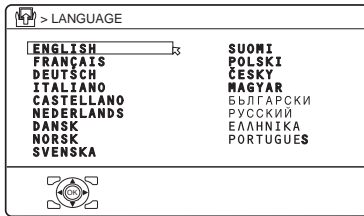

D0002(E)-EN

4 Press the ▼/▲ buttons to choose ENGLISH. Then press the OK button

The on-screen display will then be in English. The COUNTRY menu appears as a sub-menu of the AUTO PROGRAM function. There are two COUNTRY menus. Pressing the yellow button changes the COUNTRY menu as follows:

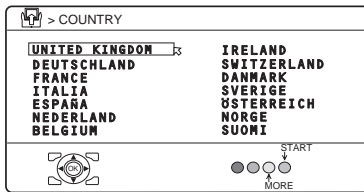

D0003-EN

5 Press the ◀/▶ and ▼/▲ buttons to choose the country where you are

6 Press the blue button to start the AUTO PROGRAM function

The AUTO PROGRAM menu appears and received TV channels are automatically stored in the programme numbers (PR).

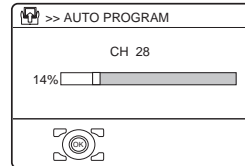

D0004-EN

- To cancel the AUTO PROGRAM function: Press the OK button.



After the TV channels have been registered in the programme numbers (PR), the EDIT menu appears

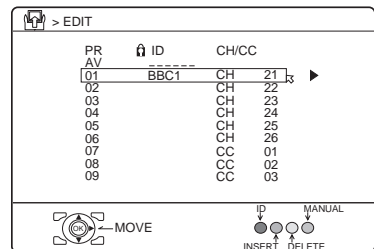

D0038-EN

- If you want to, you can now edit the programme numbers (PR) using the EDIT/MANUAL function. For details, see “EDIT/MANUAL” on page 32.
- If you do not want to edit programme numbers (PR), go to the next step.
- When the COUNTRY setting is UNITED KINGDOM, channels other than CH 21 to CH 69 (E21-E69) cannot be registered by AUTO PROGRAM.

7 Press the **OK** button to display the T-V LINK menu

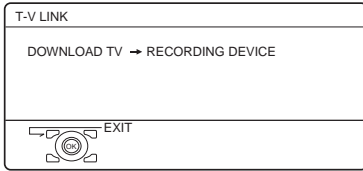

D0005-EN

If you do not have a T-V LINK compatible VCR connected:

Press the **TV** button to exit the T-V LINK menu.

The T-V LINK menu disappears.

If you have a T-V LINK compatible VCR connected to the EXT-2 terminal:

Follow the operating procedure “Downloading the data to VCR” on page 10 to transmit the Programme number (PR) data.

Now, the initial settings are complete, and you can watch the TV

- If your TV can detect the TV channel name from the TV channel broadcast signal, the TV channel name is assigned to the programme number (PR) to which the TV channel has been set. However, which TV channels are set to which programme numbers (PR) will depend on the area in which you live.
- If a TV channel you want to view is not set to a programme number (PR), you can set it using the MANUAL function. For details, see “EDIT/MANUAL” on page 32.
- The AUTO PROGRAM function does not set the programme number PR 0 (AV) for your video cassette recorder. You will need to set this using the MANUAL function.

For users in the UK:

If you have any problems setting up your new TV, please call the **JVC** Helpline on **0870 330 5000**.

For users in the Republic of Ireland:

If you have any problems setting up your new TV, please call the **JVC** Helpline on **1890-582500**.

■ Downloading the data to VCR

You can transmit to the latest Programme numbers (PR) data to a VCR with the T-V LINK function.

Caution

- This only works when a T-V LINK compatible VCR is connected to the EXT-2 terminal.
- This only works when the T-V LINK menu is being displayed.

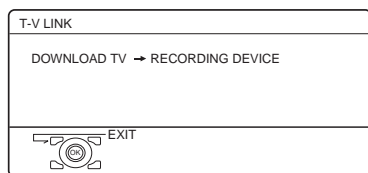

D0005-EN

1 Turn on the VCR

2 Press the OK button

The data transmission begins.



D0037-EN

The T-V LINK menu disappears once the data transmission ends.

When the T-V LINK menu is changed over to another menu:

The TV has finished its menu. This new menu is operated from the VCR. See the VCR instruction manual for what to do next.

If “FEATURE NOT AVAILABLE” appears at the T-V LINK menu:

Check the following three items. Then press the ◀ button to retry data transmission.

- Has a T-V LINK compatible VCR been connected to the EXT-2 terminal?
- Has the VCR power been turned on?
- Does the SCART cable that is connected to the EXT-2 terminal to T-V LINK compatible VCR have all its proper connections?

T-V LINK functions

When you have a T-V LINK compatible VCR connected to the EXT-2 Terminal on the TV, it is easier to set up the VCR and to view videos. T-V LINK uses the following features:

To use T-V LINK functions:

A “T-V LINK compatible VCR” means a JVC video cassette recorder with the T-V LINK logo, or with one of the following logos. However, these VCRs may support some or all of the features described earlier. For details, see your VCR instruction manual.

“Q-LINK” (a trademark of Panasonic Corporation)

“Data Logic” (a trademark of Metz Corporation)

“Easy Link” (a trademark of Phillips Corporation)

“Megalogic” (a trademark of Grundig Corporation)

“SMARTLINK” (a trademark of Sony Corporation).

■ Pre-set download

The VCR will automatically download the registered data on the TV channels from the TV. This means you do not need to set up the program channels on your VCR manually. The preset download function automatically begins when the initial setting is complete or whenever you carry out the AUTO PROGRAM or EDIT/MANUAL functions. You can also carry out this function using your VCR controls.

When “FEATURE NOT AVAILABLE” is displayed:

If “FEATURE NOT AVAILABLE” is displayed, the download was not performed correctly. Before trying to download again, check that:

- the VCR power is turned on
- the VCR is T-V LINK compatible
- the VCR is connected to the EXT-2 terminal
- the SCART cable is fully wired.

■ Direct Rec

“What You See Is What You Record”

You can easily record to VCR the images that you are watching on the TV.

For details, read the manual for your VCR. Use your VCR controls. “DEVICE IS RECORDING” is displayed.

In the following situations, the VCR will stop recording if the TV is turned off, if the TV channel or input is changed, or if the menu is displayed on the TV:

- when recording images from an external device connected to the TV (for example a camcorder)
- when recording a TV channel after it has been unscrambled on a decoder
- when recording a TV channel by using the TV’s output because the VCR’s own tuner cannot properly receive that channel.

You cannot carry out Direct Rec using your TV’s control.

Generally, the VCR cannot record a TV channel that it cannot receive properly on its own tuner, even if you can view that TV channel on the TV. However, some VCRs can record a TV channel by using the TV’s output if that channel can be viewed on the TV. For details, see your VCR instruction manual.

When the VCR is not ready, the following messages are displayed.

ERROR MESSAGE	Cause and countermeasure
NO RECORDING	The VCR is not able to record. Check the VCR.
NO RECORDING POSSIBLE	The TV input is set to EXT-4 or PC. Since the EXT-4 picture or PC picture cannot be output to EXT-2, DIRECT REC is not possible.
NO RECORDING, MEDIA PROBLEM	The recording device is not ready to record. Check the VCR tape.
NO RECORDING, DEVICE BUSY	The recording device cannot record as it is recording or playing. Check the VCR.

Refer to the VCR instruction manual.

TV buttons and functions

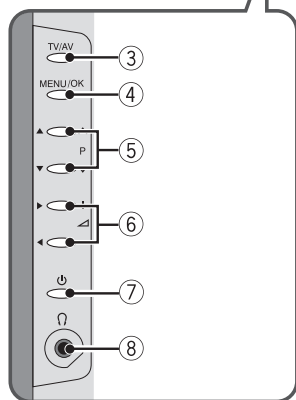
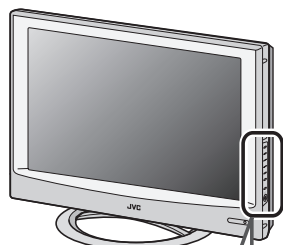
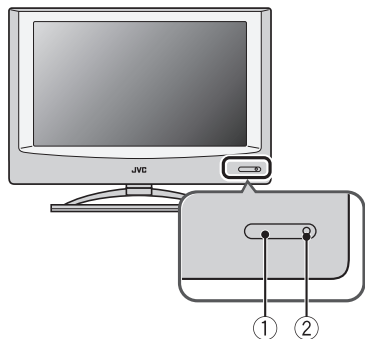

Refer to the pages in parentheses for details.

- ① Remote control sensor
- ② Power lamp (page 7)
- ③ TV/AV button (page 12)
- ④ MENU/OK button (pages 13, 24)
- ⑤ P ∇/\wedge buttons (page 12)
- ⑥ \triangleleft (Volume) $-/+$ buttons (page 13)
- ⑦ \odot (Stand by) button (page 12)
- ⑧ Headphone jack (mini jack) (page 40)

Turn the TV on from standby mode

Press the \odot button or the P ∇/\wedge buttons to turn the TV on from standby mode.

When the TV is turned on, the power lamp lights blue.

To turn the TV off:

Press the \odot button again.
The power lamp goes off.

Caution

- The \odot button on the TV does not fully isolate the TV from the AC supply. If you are not going to use the TV for a long period, be sure to disconnect the AC plug from the AC socket.

Choose a TV channel

Press the P ∇/\wedge buttons to choose a programme number (PR) or an EXT terminal

Watch images from external devices

Press the TV/AV button to choose an EXT terminal

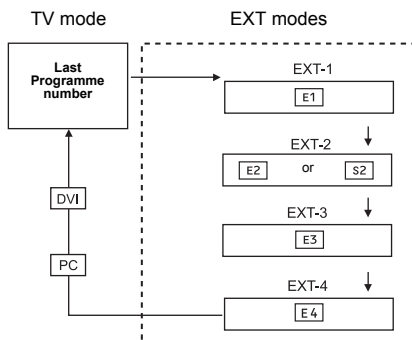

Adjust the volume

Press the  (Volume) -/+ buttons

The volume level indicator appears.

Using the Menu

Use the MENU/OK button

Refer to “Using the TV’s menu” (see page 24) for details of using the menu.

Remote control buttons and functions

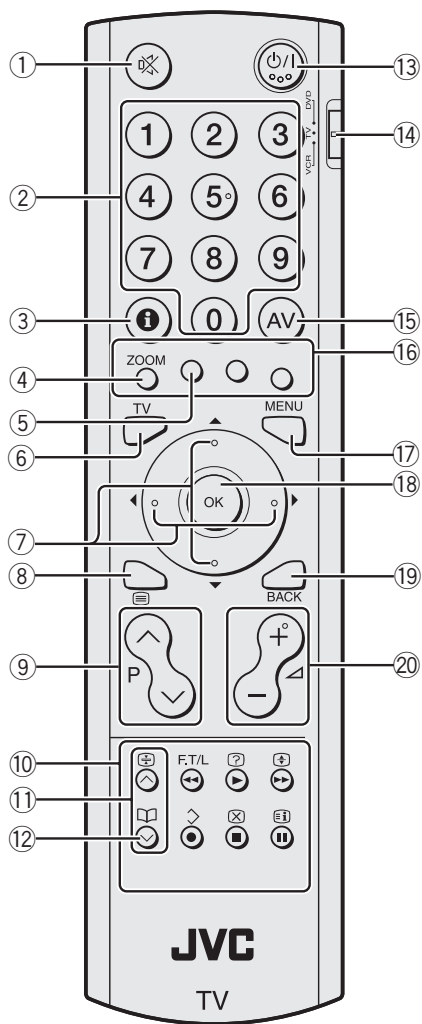

- ① Muting button
- ② Number buttons
- ③ Information button
- ④ **ZOOM** button
- ⑤ TV button
- ⑥ **TV** button
- ⑦ ◀/▶/▼/▲ buttons
- ⑧ [List] (Text) button
- ⑨ **P** V/∧ buttons
- ⑩ VCR/DVD/Teletext control buttons
- ⑪ V/∧ buttons
- ⑫ [Book] (Favourite) button
- ⑬ ⏻/⏼ (Standby) button
- ⑭ VCR/TV/DVD switch
- ⑮ **AV** button
- ⑯ Colour buttons
- ⑰ **MENU** button
- ⑱ **OK** button
- ⑲ **BACK** button
- ⑳ ◀ (Volume) -/+ buttons

Turn the TV on or off from standby mode

Press the ⏻/⏼ (standby) button to turn the TV on or off

When the TV is turned on, the power lamp lights blue.

- The power can be turned on by pressing the **TV** button, **P** V/∧ buttons or Number buttons.

To turn the TV on or off, set the VCR/TV/DVD switch on the remote control to the TV position and press the ⏻/⏼ button. If the VCR/TV/DVD switch on the remote control is set to a position other than TV, the TV will not be turned on or off even if the ⏻/⏼ button is pressed.

Choose a TV channel and watch images from external devices

- **Use the number buttons:**
Enter the programme number (PR) of the channel using the number buttons.

Example:

- PR 6 → press **6**
- PR 12 → press **1** and **2**

- **Use the P ∇/\blacktriangle buttons:**
Press the P ∇/\blacktriangle buttons to choose the programme number (PR) you want or an EXT terminal.

- **Use the AV button:**
Press the AV button to choose an EXT terminal.

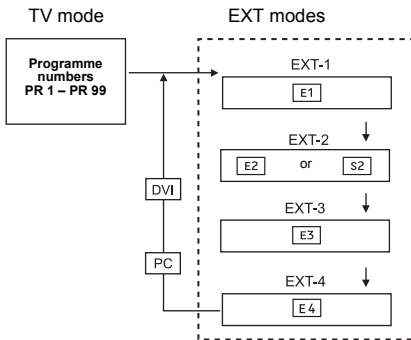

- You can choose a video input signal from the S-VIDEO signal (Y/C signal) and regular video signal (composite signal). For details, see “S-IN (S-VIDEO input)” on page 37.
- If you do not have a clear picture or no colour appears, change the colour system manually. See “COLOUR SYSTEM” on page 26.
- If you choose an EXT terminal with no input signal, the EXT terminal number becomes fixed on the screen.

- Since this TV is designed to make full use of the resolution of the original video source, the motion may appear unnatural when the video source is input with progressive-scanning component signals. If this happens, change the output setting of the connected device to interlace-scanning component signal output. See the instructions that came with the device for more information.
- The PC sound is the same as the EXT-3 sound.

To return to a TV channel:

Press the **TV** button, the ∇/\blacktriangle buttons or the number buttons.

To use the programme number PR 0 (AV):

When the TV and VCR are connected only by the aerial cable, choosing the programme number PR 0 (AV) allows you to view images from the VCR. Set the VCR RF channel to the programme number PR 0 (AV) manually. For details, see “EDIT/MANUAL” on page 32.

Pressing the **AV** button changes the choice as follows:

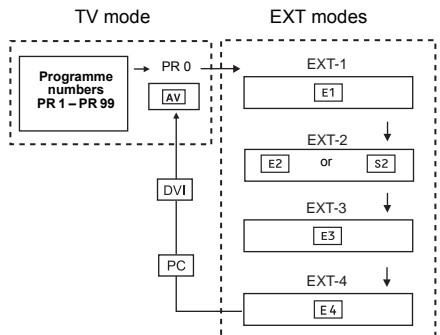

- The VCR sends its playback image along the aerial cable as an RF (radio frequency) signal.
- Also see your VCR instruction manual.

Adjust the volume

Press the buttons to adjust the volume.

The volume level indicator appears and the volume changes as you press the buttons.

■ Muting the sound

Press the (muting) button to turn off the sound.

Pressing the (muting) button again restores the previous volume level.

Information function

You can see the channel number of the programme you are watching, the current time or the PR LIST.

From the PR LIST, you can choose a channel or EXT terminal.

Press the (Information) button to display the information you want to see.

Pressing the (Information) button changes the display as follows:

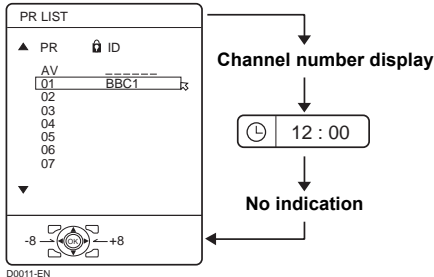

Channel number display:

The channel number and channel name (when the channel name is registered) of the programme you are watching or the EXT terminal number is displayed.

Time display:

The current time of the teletext data is displayed.

If the TV has not received a TV channel that has teletext programmes since it was turned on, the time display is blank. To view the current time, choose a TV channel that has teletext programmes.

- An incorrect current time is sometimes displayed when watching videos.

PR LIST:

The programme number (PR) and EXT terminal list is displayed.

Pressing the **OK** button after choosing the programme number (PR) or EXT terminal with the buttons will display the chosen programme or EXT terminal.

- For programme numbers (PR) for which the CHILD LOCK function is set, the (CHILD LOCK) mark is displayed. For details see “CHILD LOCK” on page 29.
- For programme numbers (PR) which is registered as a favourite channel, the (favourite) mark is displayed. For details see “Favourite channel function” on page 19.

ZOOM function

You can change the screen size according to the picture aspect ratio. Choose the optimum one from the following ZOOM modes.

- The ZOOM mode is fixed at FULL when you are using the TV as a PC screen.

AUTO:

When a WSS (Wide Screen Signalling) signal, which shows the aspect ratio of the picture, is included in the broadcast signal or the signal from an external device, the TV automatically changes the ZOOM mode to 16:9 ZOOM mode or FULL mode according to the WSS signal.

If a WSS signal is not included, the picture is displayed according to the ZOOM mode set with the 4:3 AUTO ASPECT function.

- For details of the 4:3 AUTO ASPECT function, see “4:3 AUTO ASPECT” on page 27.
- When the AUTO (WSS) mode does not function correctly due to poor WSS signal quality or when you want to change the ZOOM mode, press the **ZOOM** button and change to another ZOOM mode.

REGULAR:

Use to view a normal picture (4:3 aspect ratio) as this is its original shape.



PANORAMIC:

This stretches the left and right sides of a normal picture (4:3 aspect ratio) to fill the screen, without making the picture appear unnatural.

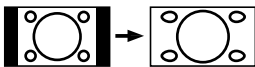

- The top and bottom of the picture are slightly cut off.

14:9 ZOOM:

This zooms up the wide picture (14:9 aspect ratio) to the upper and lower limits of the screen.



16:9 ZOOM:

This zooms up the wide picture (16:9 aspect ratio) to the full screen.

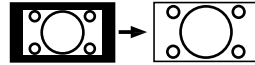

16:9 ZOOM SUBTITLE:

This zooms up the wide picture (16:9 aspect ratio) with subtitles to the full screen.

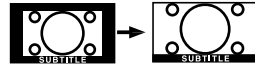

FULL:

This uniformly stretches the left and right sides of a normal picture (4:3 aspect ratio) to fill the wide TV screen.

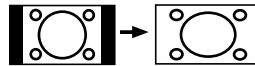

- For 16:9 aspect ratio pictures that have been squeezed into a normal picture (4:3 aspect ratio), use the FULL mode to restore the picture to its original shape.

■ Choose the ZOOM mode

1 Press the **ZOOM** button to display the ZOOM menu

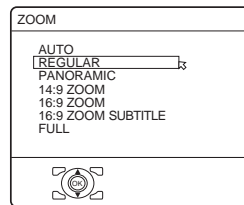

00009-EN

2 Press the **▼/▲** buttons to choose a ZOOM mode. Then press the **OK** button

The picture expands and the chosen ZOOM mode is displayed in about 5 seconds.

- The ZOOM mode may be automatically changed by the control signal from an external device. When you want to return to the previous ZOOM mode, choose the ZOOM mode again.

■ Adjusting the visible area of the picture

If subtitles or the top (or bottom) of the picture are cut off, you can adjust the visible area of the picture manually.

1 Press the **ZOOM** button

The ZOOM menu appears.

2 Press the **OK** button to display the ZOOM mode indicator

The indicator appears.

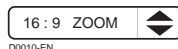

3 While it is displayed, press the **▼/▲** buttons to change the position of the picture

- You cannot adjust the visible area in REGULAR or FULL mode.

The visible area adjustment is saved even after the TV channel is changed. However, it is cancelled if the following operations are performed.

- The power is turned off/on
- The ZOOM mode is changed
-  (Text) button is pressed
- The TV is switched between TV mode and EXT mode

3D SOUND function

You can enjoy sounds with a wider ambience.

- This function does not work for the sound from headphones.

Press the button to select one of 3D SOUND modes

ON:

When you listen to stereo sound, please select ON mode.

You can enjoy sound similar to the experience at the theatre.

MONO:

Select the MONO mode, when you listen to the mono sound.

You can enjoy the sound for a wider audience similar to stereo sound.

OFF:

The 3D SOUND function switches off.

- You can choose the 3D SOUND mode with the “SOUND menu” (see page 28).

Return to TV channel instantly

You can return to a TV channel instantly.

Press the **TV** button

The TV returns to the TV mode and a TV channel appears.

Favourite channel function

You can register your favourite TV channels (PR 1 – PR 99) in the number buttons 1 to 4. After registering, the channel can be called by pressing the  (favourite) button and a number button 1 to 4.

■ Favourite channel registration

1 In the normal screen, choose a TV channel (PR 1 – PR 99) that you want to register

For details, refer to “Choose a TV channel and watch images from external devices” on page 15.

2 Press and hold the (favourite) button for three seconds or more

Then “SET 1-4?” appears on the screen.

3 Press one of the number buttons 1 to 4

The current channel is registered in the pressed number button.

After “PROGRAMMED!” appears on the screen, the favourite channel icon appears at the top-right of the screen.

- If the channel you are trying to register is already registered in one of the other number buttons 1 to 4, “NOT AVAILABLE” appears on the screen.
- Channels locked with the CHILD LOCK function cannot be registered.
- If AUTO PROGRAM is performed, the registered favourite channels are reset.

- When you want to delete a favourite channel, delete the set channel and set contents with FAVOURITE SETTING (see page 31) in the FEATURES menu.
-

■ Calling the favourite channel

1 In the normal screen, press the (favourite) button

Then “FAVORITE1-4?” appears.

2 Press one of the number buttons 1 to 4

The called favourite channel appears on the screen.

- If a number button in which no channel is registered is pressed, “NO MEMORY” appears on the screen.

■ Setting the picture effect

When a favourite channel has been chosen with the  (favourite) button and number buttons 1 to 4, picture effect settings can be memorised for each favourite channel by setting the picture effects in the PICTURE menu (see page 25).

The following items in the PICTURE menu (see page 25) are memorised.

PICTURE MODE
BRIGHT-1
CONTRAST
BRIGHT-2
SHARP
COLOUR
HUE
COLOUR TEMP.
DIGITAL VNR
COLOUR SYSTEM

The last setting made for each item is memorised.

Operating a JVC brand VCR or DVD player

These buttons will operate a JVC brand VCR or DVD player. Pressing a button that looks the same as the device's original remote control button has the same effect as the original remote control.

1 Set the VCR/TV/DVD Switch to the VCR or DVD position

VCR:

When you are operating the VCR, set the switch to the VCR position.

- You can turn the VCR on or off with the \odot/I (standby) button.

DVD:

When you are operating the DVD player, set the switch to the DVD position.

- You can turn the DVD player on or off with the \odot/I (standby) button.
- You can also press the **MENU** or **TOP MENU** button and display the DVD disc menu screen, and then operate by pressing the $\blacktriangleleft/\blacktriangleright/\blacktriangledown/\blacktriangleup$ buttons.

2 Press the VCR/DVD Control Button to control your VCR or DVD player

- If your device is not made by JVC, these buttons will not work.
- Even if your device is made by JVC, some of these buttons may not work, depending on the device you are using.
- You can use the \vee/\wedge buttons to choose a TV channel the VCR will receive, or choose the chapter the DVD player plays back.
- Some models of DVD player use the \vee/\wedge buttons for both operating the fast forward/backward functions and for choosing the chapter. In this case, the $\blacktriangleleft/\blacktriangleright$ buttons do not work.

You cannot turn the TV on or off when the VCR/TV/DVD switch is set to the VCR or DVD position.

When you turn the TV on or off, set the VCR/TV/DVD switch to the TV position.

Teletext function

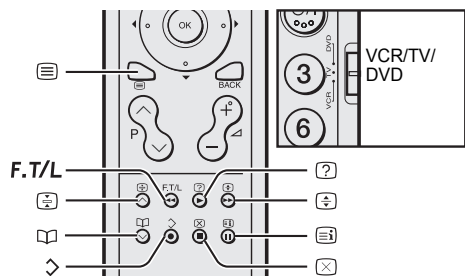



Basic operation

1 Choose a TV channel with a teletext broadcast

2 Set the VCR/TV/DVD switch to the TV position



3 Press  (Text) button to display the teletext

Pressing  (Text) button changes the mode as follows:

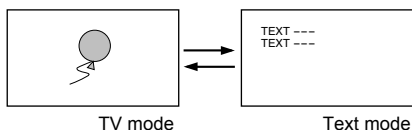

4 Choose a teletext page by pressing the P \vee/\wedge buttons, number buttons or colour buttons

To return to the TV mode:

Press the **TV** button or  (Text) button.

- If you have trouble receiving teletext broadcasts, consult your local dealer or the teletext station.
- The ZOOM function will not work in the TV and text mode or Text mode.
- You cannot operate menus when viewing a teletext programme.
- Language display depends on the country which was set on the COUNTRY menu. If characters on a Teletext programme do not appear properly, change the COUNTRY setting to other country's. To change the COUNTRY setting, perform steps 1 and 2 of the "AUTO PROGRAM" procedure on page 32 and then press the **OK** button.

Using the List Mode

You can store the numbers of your favourite teletext pages in memory and call them up quickly using the colour buttons.

■ **To store the page numbers:**

1 Press F.T/L button to go into the List mode

The page numbers you have stored are displayed at the bottom of the screen.

- 2 Press a colour button to choose a position. Then press the number buttons to enter the page number**

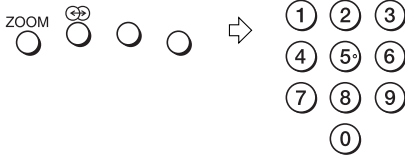

- 3 Press and hold down the ↵ (Store) button**

The four page numbers blink white to show that they are stored in memory.

■ **To call up a stored page:**

- 1 Press the F.T/L button to enter the List mode**

- 2 Press a colour button having a stored page**

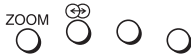

To exit the List mode:
Press the F.T/L button again.

Hold

You can hold a teletext page on the screen for as long as you want, even while several other teletext pages are being received.

- Press the ⏸ (Hold) button**

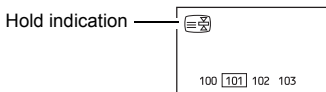

To cancel the Hold function:
Press ⏸ (Hold) button again.

Sub-page

Some teletext pages include sub-pages that are automatically displayed. You can hold any sub-page, or view it at any time.

- 1 Press the 📖 (Favourite) button to operate the Sub-page function**

- 2 Press the Number buttons to enter a sub-page number**

Example:

- 3rd sub-page → press **0, 0, 0** and **3**.

To cancel the Sub-page function:

Press the 📖 (Favourite) button again.

Reveal

Some teletext pages include hidden text (such as answers to a quiz). You can display the hidden text.

- Each time you press the ? (Reveal) button, text is hidden or revealed**

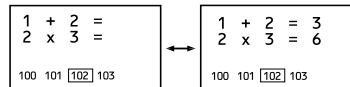

Size

You can double the height of the teletext display.

- Press the ⏏ (Size) button**

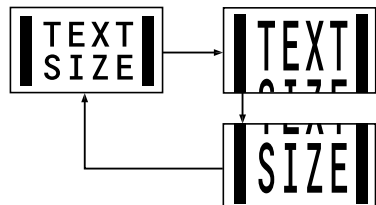

Index

You can return to the index page instantly.

Press the (Index) button

Returns to page 100 or a previously specified page.

Cancel

You can search for a teletext page while watching TV.

1 Press the number button to enter a page number, or press a colour button

The TV searches for a teletext page.

2 Press (Cancel) button

The TV programme appears. When the TV finds the teletext page, its page number appears in the upper left of the screen.

3 Press (Cancel) button to return to a teletext page when the page number is on the screen

- The TV mode cannot be resumed by pressing the  (Cancel) button. To return to the TV mode press **TV**.

Using the TV's menu

This TV has a number of functions you can operate using menus. To use all your TV's functions, you need to understand the basic menu operating techniques fully.

Buttons used to operate the menus

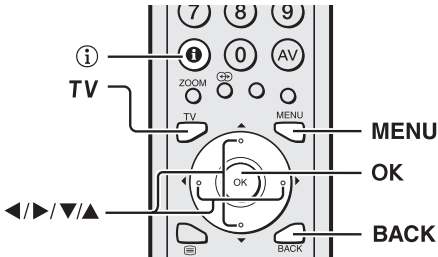

Basic operation

1 Press the **MENU** button to display the menu bar



2 Press the **◀/▶** buttons to choose the menu you want to use and then press the **OK** button



3 Press the **▼/▲** buttons to choose the item to be set, press the **◀/▶** buttons to set the item, and then press the **OK** button

If there are sub-menus, use the **◀/▶/▼/▲** buttons to operate them.

- Press the **BACK** button to return to the previous menu.
- Press the **TV** or **MENU** button to exit from the menu.
- Some menu items may not be operated or set depending on the TV status or other menu item settings. Menu items that cannot be operated or set are displayed in grey in the menu and cannot be chosen.

Types of menu



PICTURE menu

Choose to set the screen settings.



SOUND menu

Choose to set the sound settings.



FEATURES menu

Choose to set the sleep timer and child lock settings.



SET UP menu

Choose to edit the channels or set the display language settings.

- The menu will disappear after about one minute if no operation is performed.

Operation with the buttons on the TV

You can also operate the menus using the buttons on the front panel of the TV.

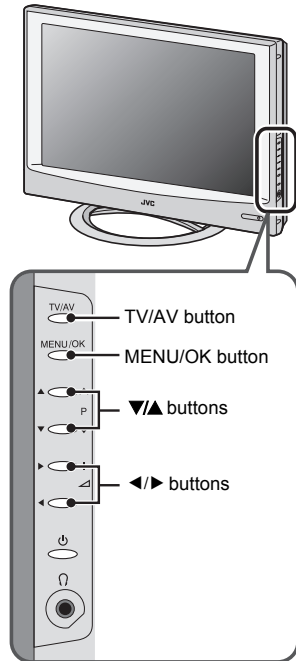

PICTURE menu

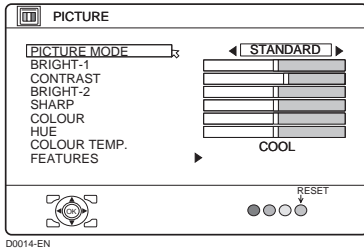

- While the PICTURE menu is displayed, pressing the blue button will set the BRIGHT-1, CONTRAST, BRIGHT-2, SHARP, COLOUR, HUE settings to their default settings.
- When watching the picture from EXT-1 to EXT-4 or the PC, picture effect settings can be memorised for each external input by setting the picture effects in the PICTURE menu.

The following items in the PICTURE menu are memorised.

PICTURE MODE

BRIGHT-1

CONTRAST

BRIGHT-2

SHARP

COLOUR

HUE

COLOUR TEMP.

DIGITAL VNR

COLOUR SYSTEM

The last setting made for each item is memorised.

PICTURE MODE

You can choose one of three PICTURE MODEs to adjust the picture settings automatically.

BRIGHT:

Heightens contrast and sharpness.

STANDARD:

Standardizes picture adjustment.

SOFT:

Softens contrast and sharpness.

BRIGHT-1

You can adjust the back light.

◀ : darker

▶ : brighter

CONTRAST

You can adjust the picture contrast.

◀ : lower

▶ : higher

BRIGHT-2

You can adjust the picture brightness.

◀ : darker

▶ : brighter

SHARP

You can adjust the picture sharpness.

◀ : softer

▶ : sharper

COLOUR

You can adjust the picture colour.

◀ : lighter

▶ : deeper

HUE

You can adjust the picture tint.

◀ : reddish

▶ : greenish

- You can change the HUE setting (picture hue) when the colour system is NTSC 3.58, or NTSC 4.43.

COLOUR TEMP.

You can select one of three COLOUR TEMP. modes (three tones of white) to adjust the white balance of the picture. Since white is the colour which is used as a reference for all the other colours, changing the COLOUR TEMP. mode affects the appearance of all the other colours on the screen.

COOL:

A bluish white. Using this mode when watching bright pictures allows you to enjoy a more vivid and bright picture.

NORMAL:

The normal white colour.

WARM:

A reddish white. Using this mode when watching films allows you to enjoy colours that are characteristic of films.

FEATURES

Choose **FEATURES** and press the **OK** or **▶** button to display the sub-menu.

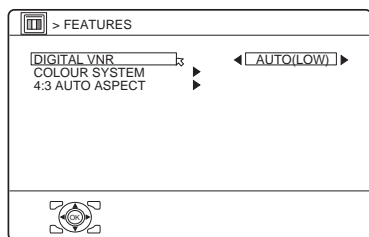

D1015-EN

■ **DIGITAL VNR**

The **DIGITAL VNR** function cuts down the amount of 'noise' ('snow' or interference) in the original picture.

ON:

This function is turned on.

OFF:

This function is turned off.

■ **COLOUR SYSTEM**

The colour system is chosen automatically. However, if the picture is not clear or no colour appears, choose the colour system manually.

1 Choose COLOUR SYSTEM. Then press the OK or ▶ button

The sub-menu of the **COLOUR SYSTEM** function appears.

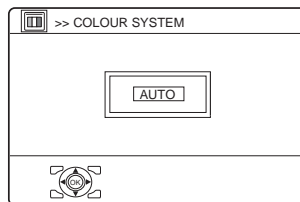

D0016-EN

2 Press the ▼/▲ buttons to choose the appropriate colour system. Then press the OK button

PAL:

PAL system

SECAM:

SECAM system

NTSC 3.58:

NTSC 3.58 MHz system

NTSC 4.43:

NTSC 4.43 MHz system

AUTO:

This function detects a colour system from the input signal. You can only use this when you are viewing a picture from programme number PR 0 (AV), or an EXT terminal.

- The **AUTO** function may not function properly if you have poor signal quality. If the picture is abnormal in the **AUTO** function, choose another colour system manually.
- When in the Programme numbers PR 0 (AV) to PR 99, you cannot choose NTSC 3.58 or NTSC 4.43.
- **COLOUR SYSTEM** cannot be chosen when you are watching the PC picture.

■ 4:3 AUTO ASPECT

You can choose one of three ZOOM modes, REGULAR, PANORAMIC or 14:9 ZOOM, as the ZOOM mode for the normal picture (4:3 aspect ratio).

- 1 Choose 4:3 AUTO ASPECT then press the **OK** button

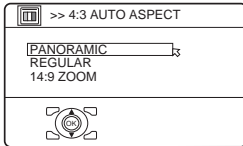

D0017-EN

- 2 Press the **▼/▲** buttons to choose a ZOOM mode

SOUND menu

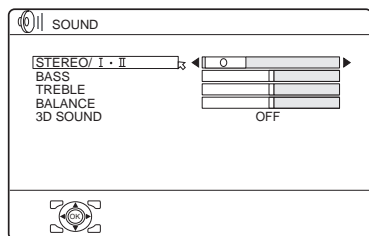

- When the headphones are connected, only “STEREO / I • II” can be used.

STEREO / I • II

When you are viewing a bilingual broadcast programme, you can choose the sound from Bilingual I (Sub I) or Bilingual II (Sub II). If you have poor reception on a stereo broadcast, you can change from stereo to mono sound so that you can hear the broadcast more clearly and easily.

∞ : Stereo sound

O : mono sound

I : Bilingual I (sub I)

II : Bilingual II (sub II)

- The sound mode you can choose differs depending on the TV programme.
- This function does not work in the EXT modes.

BASS

You can adjust the low tone of the sound.

◀ : weaker

▶ : strong

TREBLE

You can adjust the high tone of the sound.

◀ : weaker

▶ : strong

BALANCE

You can adjust the volume balance between the left and right speaker.

◀ : turn the left speaker’s volume level up.

▶ : turn the right speaker’s volume level up.

3D SOUND

You can enjoy Surround sound with a “live” effect by using the 3D SOUND function.

- You can choose a 3D SOUND mode from ON, MONO and OFF modes. For details, see “3D SOUND function” on page 18.
- You can also operate the 3D SOUND function with the  button. For details, see “3D SOUND function” on page 18.

FEATURES menu

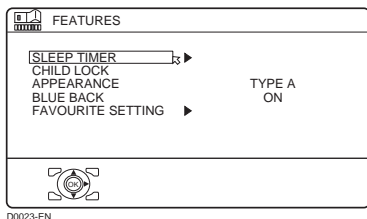

SLEEP TIMER

You can set the TV to automatically turn off after a set period of time.

1 Choose SLEEP TIMER. Then press the OK or ► button

A Sub-menu of the SLEEP TIMER function appears.

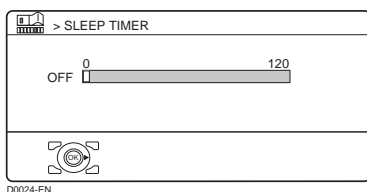

2 Press the ◀/▶ buttons to set the period of time. Then press the OK button

You can set the period of time for up to 120 minutes (2 hours) in 10 minute steps.

- One minute before the SLEEP TIMER function turns off the TV, “GOODNIGHT!” appears.
- The SLEEP TIMER function cannot be used to turn off the TV’s main power.
- When the SLEEP TIMER function is on, you can display the sub-menu of the SLEEP TIMER function again to confirm or change the remaining period of time of the SLEEP TIMER function. Press the OK button to leave the menu after confirming or changing the remaining time.

To cancel the SLEEP TIMER function:

Press the ◀ button to set the period of time to “OFF”.

CHILD LOCK

When there is a TV channel you do not want your children to watch, you can use the CHILD LOCK function to lock out the TV channel. Even when a child chooses a programme number (PR) for a locked TV channel the screen will change to blue and display  (CHILD LOCK) so the TV channel cannot be viewed. Unless you enter a pre-set ID number by a special operation, the lock cannot be released and the child cannot view the TV channel.

■ To set the CHILD LOCK function

1 Choose CHILD LOCK, then press the 0 button

“SET ID NO.” (ID number setting screen) appears.

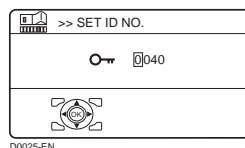

2 Set the ID number to your liking

1 Press the ▼/▲ buttons to choose a number.

2 Press the ◀/▶ buttons to move the cursor.

3 Press the OK button

The Sub-menu of CHILD LOCK appears.

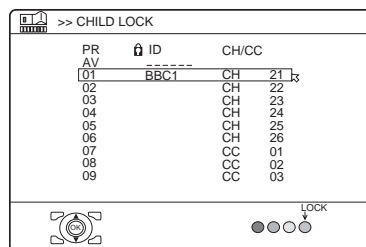

4 Press the ▼/▲ buttons to choose a TV channel

Every time you press the ▼/▲ buttons, the Programme number (PR) changes, and the picture of the TV channel registered in the Programme number (PR) is displayed on the screen.

5 Press the blue button and set the CHILD LOCK function. Then press the OK button

🔒 (CHILD LOCK) appears and the TV channel is locked.

To reset the CHILD LOCK function:

Press the blue button again.

🔒 (CHILD LOCK) disappears.

To disable easy resetting of the CHILD LOCK function, the menu disappears if you choose the CHILD LOCK function and press the **OK** button.

■ To view a locked TV channel

1 Choose a programme number (PR) of a locked TV channel with the number buttons or PR LIST

The screen changes to blue and the 🔒 (CHILD LOCK) appears. You cannot view the TV channel.



D0027-EN

2 Press the ⓘ (Information) button to display “ID NO.” (ID No. input screen)

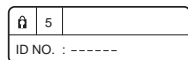

D0028-EN

3 Press the number buttons to enter the ID number

The lock is temporarily released so you can view the TV channel.

If you have forgotten the ID number:

Perform step 1 of “To set the CHILD LOCK function”. After confirming the ID number, press the **TV** button to exit the menu.

- Even if you reset the lock temporarily, it does not mean that the CHILD LOCK function set for the TV channel is cancelled. The next time anyone tries to view the TV channel, it will be locked again.
- When you want to cancel the CHILD LOCK function, you must perform the operation “To set the CHILD LOCK function” again.
- To stop it being easy to choose the programme number (PR) of a locked TV channel, the programme number (PR) has been set so that it cannot be chosen with the ▼/▲ buttons or the buttons of the TV.
- To stop it being easy to reset the lock, “ID NO.” (ID No. input screen) is set so that it cannot appear unless you press the ⓘ (Information) button.

APPEARANCE

Press the ◀/▶ button and choose the format in which the channel number is displayed from two types: TYPE A and TYPE B.

BLUE BACK

You can set the TV to automatically change to a blue screen and mute the sound if the signal is weak or absent, or when there is no input from an external device.

ON:

This function is turned on.

OFF:

This function is turned off.

FAVOURITE SETTING

Chose when deleting the favourite channels registered in the buttons 1 to 4.

1 Choose FAVOURITE SETTING, then press the OK or ► button

The FAVOURITE SETTING menu appears.

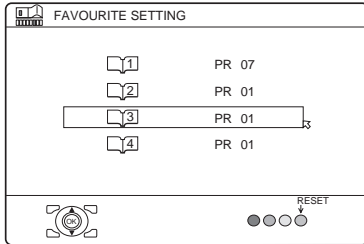

D0112-EN

2 Press the ▼/▲ buttons and chose the favourite channel that you want to delete

3 Press the blue button

The chosen favourite channel and set contents are deleted.

- For details of the favourite channels, see “Favourite channel function” on page 19.
-

SET UP menu

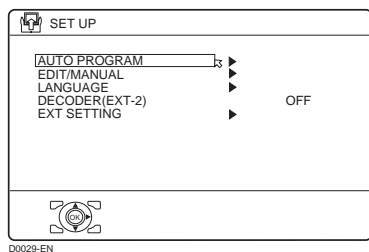

AUTO PROGRAM

You can again perform the AUTO PROGRAM function TV channel automatic registration which was performed in the “Initial settings” (page 7).

1 Choose AUTO PROGRAM, then press the OK or ► button

The COUNTRY menu appears as a sub-menu of the AUTO PROGRAM function. There are two COUNTRY menus. Pressing the yellow button changes the COUNTRY menu as follows:

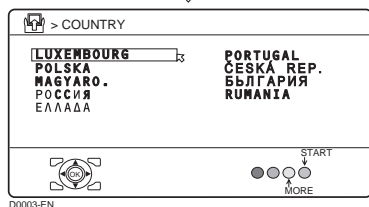
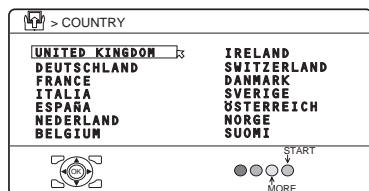

2 Press the ◀/▶ and ▼/▲ buttons to choose the country where you are

3 Perform steps 5 and 6 of the “Initial settings” (page 8)

EDIT/MANUAL

The EDIT/MANUAL functions are divided into two types:

- editing the current programme numbers (PR) (EDIT functions); and
- manually storing a TV channel you want to view on a particular programme number (PR) (MANUAL function).

Here are the details about these functions:

MOVE:

This function changes the programme number (PR) of a TV channel.

ID:

This function registers a channel name (ID) to a TV channel.

INSERT:

This function adds a new TV channel in the current programme numbers (PR) list by using the CH/CC number.

- You cannot use the INSERT function if you do not know the channel number of a TV channel. Use the MANUAL function to register a TV channel in the programme number (PR).

DELETE:

This function deletes a TV channel you do not want to list.

MANUAL:

This function manually stores a new TV channel in a programme number (PR).

Caution

- Using the MOVE, DELETE or INSERT functions rewrites the current programme numbers (PR) list. Therefore, the programme numbers (PR) of some of the TV channels will change.
- Using the MANUAL function for a TV channel for which the CHILD LOCK function has been set cancels the CHILD LOCK function for that channel.

- Using the MANUAL function for a TV channel for which the DECODER (EXT-2) function has been set to ON returns the setting of the DECODER (EXT-2) function for that channel to OFF.
- When a TV channel has already been registered in PR 99, using the INSERT function deletes that TV channel.

Basic operation

1 Choose EDIT/MANUAL, then press the OK or ► button

The EDIT menu appears.

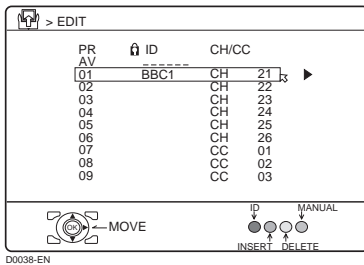

D0038-EN

2 Follow the description for the function you want to use

3 Press the OK button to complete the settings

The T-V LINK menu appears.

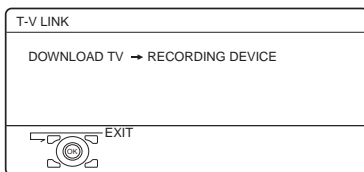

D0005-EN

If you do not have a T-V LINK compatible VCR connected:

Press the TV button to exit the T-V LINK menu.

The T-V LINK menu disappears.

If you have a T-V LINK compatible VCR connected to the EXT-2 terminal:

Follow “Downloading the data to VCR” on page 10 to transmit the programme number (PR) data.

- For programme number PR 0, “AV” appears in the programme numbers (PR) list.
- An EXT terminal number does not appear in the programme numbers (PR) list.

MOVE

1 Press the ▼/▲ buttons to choose a TV channel

2 Press the ► button to start the MOVE function

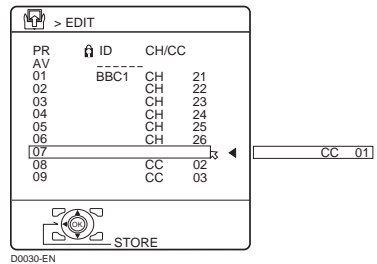

D0030-EN

3 Press the ▼/▲ buttons to choose a new programme number (PR)

To cancel the MOVE function:
Press the BACK button.

4 Press the ◀ button to change the programme number (PR) of a TV channel to a new programme number (PR)

DELETE

1 Press the ▼/▲ buttons to choose a TV channel

2 Press the yellow button to delete the TV channel

The TV channel is deleted from the programme numbers (PR) list.

■ ID

1 Press the ▼/▲ buttons to choose a TV channel

2 Press the red button to start the ID function

PR AV	ID	CH/CC
01	BBC1	CH 21
02		CH 22
03		CH 23
04		CH 24
05		CH 25
06		CH 26
07		CC 01
08		CC 02
09		CC 03

D0031-EN

3 Press the ▼/▲ buttons to choose a character

PR AV	ID	CH/CC
01	BBC1	CH 21
02		CH 22
03		CH 23
04		CH 24
05		CH 25
06		CH 26
07		CC 01
08		CC 02
09		CC 03

D0032-EN

4 Press the ◀/▶ buttons to move the cursor

5 Repeat steps 3 and 4 to complete the channel name

6 Press the OK button to give a channel name (ID) to a TV channel

Before performing INSERT or MANUAL operation

- If you register the TV channel (SECAM-L system) from a French station, be sure to set the COUNTRY setting to FRANCE. If the COUNTRY setting is not set to FRANCE, perform steps 1 and 2 of the “AUTO PROGRAM” (page 32) procedure and set the COUNTRY setting to FRANCE before pressing the **OK** button.
- A CH/CC number unique to this TV and corresponding to the Channel number of a TV channel is required. Find the corresponding CH/CC number from a table “CH/CC numbers” on page 44 based on the Channel number of the TV channel.
- When the COUNTRY setting is not FRANCE, use a two-digit CH/CC number. When the COUNTRY setting is FRANCE, use a three-digit CH/CC number.

■ INSERT

- 1 Press the **▼/▲** buttons to choose a programme number (PR) for which you will register a new TV channel
- 2 Press the green button and start the **INSERT** function

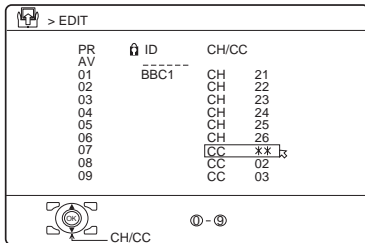

To cancel the INSERT function:
Press the **BACK** button.

- 3 Press the **▼/▲** buttons to choose "CH" or "CC", then enter the remaining CH or CC number

When the COUNTRY setting is FRANCE:

Choose "CH1", "CH2", "CC1" or "CC2".

The TV shifts to registration mode.

When the registration is completed, the picture of the TV channel appears on the screen.

- The CH/CC number is a number given to each broadcast frequency that carries a TV channel. If the TV cannot detect the TV channel corresponding to the broadcast frequency indicated by the CH/CC number, a "no-signal" picture appears.

■ MANUAL

- 1 Press the **▼/▲** buttons to choose a programme number (PR) for a new TV channel
- 2 Press the blue button to activate the **MANUAL** function

At the right side following the CH/CC number, the SYSTEM (broadcasting system) of the TV channel appears.

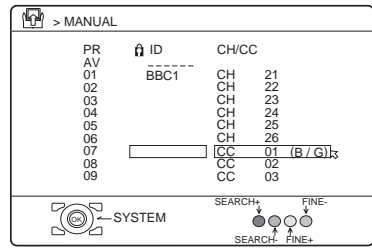

To cancel the MANUAL function:
Press the **BACK** button.

- 3 Press the **▶** button to choose the **SYSTEM (broadcasting system)** for a TV channel you want to register **TV channel (SECAM-L system) from a French station:**

Set the SYSTEM to "L". If it is set to one other than "L", you cannot receive the TV channel of the SECAM-L system.

Other TV channels:

If you do not know the correct broadcasting system, set the SYSTEM to "B/G". If "B/G" is not correct, you will not hear the sound normally when the TV detects a TV channel. In this case, retry to set the SYSTEM correctly so that no problem arises.

4 Press the green or red button to search for a TV channel

Scanning stops when the TV finds a TV channel. Then the TV channel is displayed.

5 Press the green or red button repeatedly until the TV channel you want appears

If the TV channel reception is poor:
Press the blue or yellow button to fine-tune the TV channel.

6 Press the OK button and register the TV channel to a Programme number (PR)

The normal EDIT menu is resumed.

LANGUAGE

The LANGUAGE setting which was performed in the “Initial settings” (page 7) can be changed.

1 Choose LANGUAGE, then press the OK or ► button

A sub-menu of the LANGUAGE function appears.

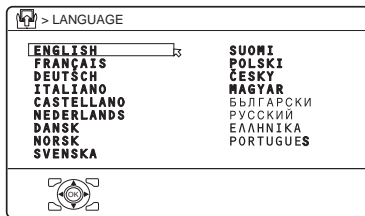

D0002-EN

2 Press the ◀/▶ and ▼/▲ buttons to choose a language. Then press the OK button

DECODER (EXT-2)

If you have a decoder connected to a T-V LINK compatible VCR, which in turn is connected to the EXT-2 terminal, use the DECODER (EXT-2) function to unscramble the scrambled TV channels.

1 Turn on the decoder power

2 Display the scrambled TV channel on the TV

Even if the decoder is working, a scrambled picture appears.

3 Display the SET UP menu and choose DECODER (EXT-2)

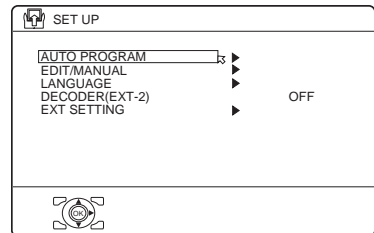

D0029-EN

4 Press the ◀/▶ buttons to choose ON

An unscrambled picture appears.

To cancel the DECODER (EXT-2) function:

Press the ◀/▶ buttons to choose OFF.

5 Press the OK button to complete the setting

The T-V LINK menu appears.

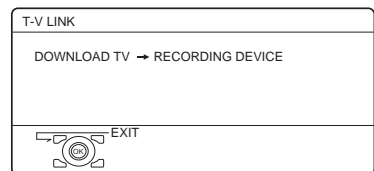

D0005-EN

You can send the programme numbers data to a VCR with the T-V LINK function.

6 Turn on the VCR, and then press the OK button to transmit the data to VCR

The T-V LINK menu disappears once the data transmission ends.

If the DECODER (EXT-2) function has been set to “ON” but the TV channel cannot be unscrambled, check the following:

- Has the decoder been connected to the VCR properly according to the VCR and decoder instruction manuals?
- Has the decoder power been turned on?
- Can the TV channel be unscrambled with a decoder?
- Do you need to change the VCR settings in order to connect the decoder? Confirm that the VCR is set properly by rechecking the VCR instruction manual.

EXT SETTING

1 Choose EXT SETTING, then press the OK or ► button

The EXT SETTING menu appears.

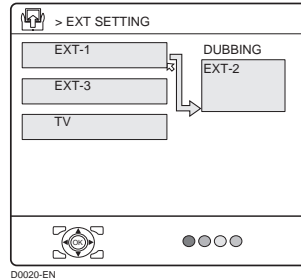

2 Follow the instructions for the function you want to use and operate the function

S-IN:

You can enjoy the high-quality picture of the S-VIDEO signal (Y/C signal).

DUBBING:

You can choose a signal source to be output from an EXT-2 terminal.

■ S-IN (S-VIDEO input)

You can connect a device (such as an S-VHS VCR) to enjoy the high-quality picture of the S-VIDEO signal (Y/C signal).

Preparation:

- First read the device’s instruction manual and “Additional preparation” on page 40 to connect the device to the TV properly. Second, follow the device’s instruction manual to set the device so that it sends an S-VIDEO signal (Y/C signal) to the TV.
- Do not set S-IN (S-VIDEO input) to an EXT terminal connected to a device which cannot output an S-VIDEO (Y/C signal).

1 Press the ◀/▶ or ▼/▲ buttons to choose an EXT terminal

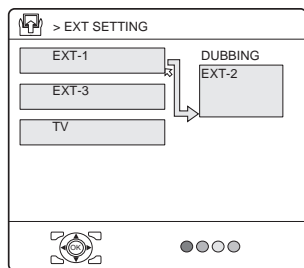

D0020-EN

- Setting S-IN (S-VIDEO input) changes the head character from “E” to “S”. When an EXT terminal receives a normal video signal, “E2” appears on the display. This changes to “S2” when it receives an S-VIDEO signal.
- Even a device which can output an S-VIDEO signal (Y/C signal) may output a regular video signal (composite signal) depending on the device setting. If a picture cannot appear because the S-IN (S-VIDEO input) setting has been made, read the device instruction manual carefully again to check for the device settings.

■ DUBBING

You can choose a signal source to be output from the EXT-2 terminal.

You can do this with the output signals of the devices connected to other EXT terminals, or with the picture and sound from a TV channel you are currently viewing.

1 Press the ◀/▶ buttons to choose the arrow from the menu

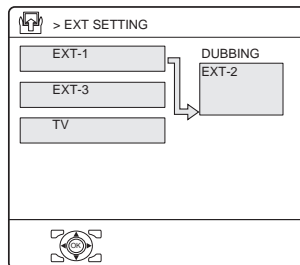

D0022-EN

2 Press the ▼/▲ buttons to choose an EXT terminal or TV. Then press the OK button

The arrow in the menu represents a signal flow. The left side of the arrow shows a signal source output from the EXT-2 terminal.

EXT-1/EXT-3:

The output signal of the device connected to an EXT terminal passes through the TV and is output from the EXT-2 terminal.

TV:

The picture and sound of the TV channel you are currently viewing are output from the EXT-2 terminal.

-
- During dubbing, you cannot turn off the TV. Turning off the TV also turns off the output from the EXT-2 terminal.
 - When you choose an EXT terminal as an output, you can view a TV programme or a picture from the other EXT terminal while dubbing the picture from a device connected to the EXT terminal onto a VCR connected to the EXT-2 terminal.
 - The RGB signals from TV games cannot be output. Teletext programmes cannot be output.
-

Additional preparation

Connecting external equipment

Connect the equipment to the TV, making the correct rear panel and front panel connections.

Before connecting anything:

- Read the manuals that came with the equipment.
Depending on the equipment, the connection method may be different from the diagram. Also, the equipment settings may need to change depending on the connection method.
- Turn off all the equipment including the TV.
- The “Specifications” on Back Cover give the details of the EXT terminals. If you are connecting equipment not listed in the following connection diagram, see the table to choose the best EXT terminal.
- Connecting cables are not supplied.

- ① VCR (composite signal)
- ② VCR (composite signal/S-VIDEO signal)
- ③ T-V LINK compatible VCR (composite signal/S-VIDEO signal)
- ④ Decoder
- ⑤ DVD player (composite signal/S-VIDEO signal)
- ⑥ DVD player (composite signal/RGB signal)
- ⑦ DVD player (component video signals; Y/Pb/Pr)
- ⑧ DVD player (digital video signals)
- ⑨ TV game (composite signal/RGB signal)
- ⑩ TV game (composite signal)
- ⑪ Headphones
- ⑫ Camcorder (composite signal)
- ⑬ Computer (analogue RGB signal)
- ⑭ SCART cable
- ⑮ Audio cable
- ⑯ Video cable
- ⑰ Component cable
- ⑱ DVI-HDMI converter cable
- ⑲ DVI cable
- ⑳ “DVI-I”-“D-SUB” converter cable

without terminal covers

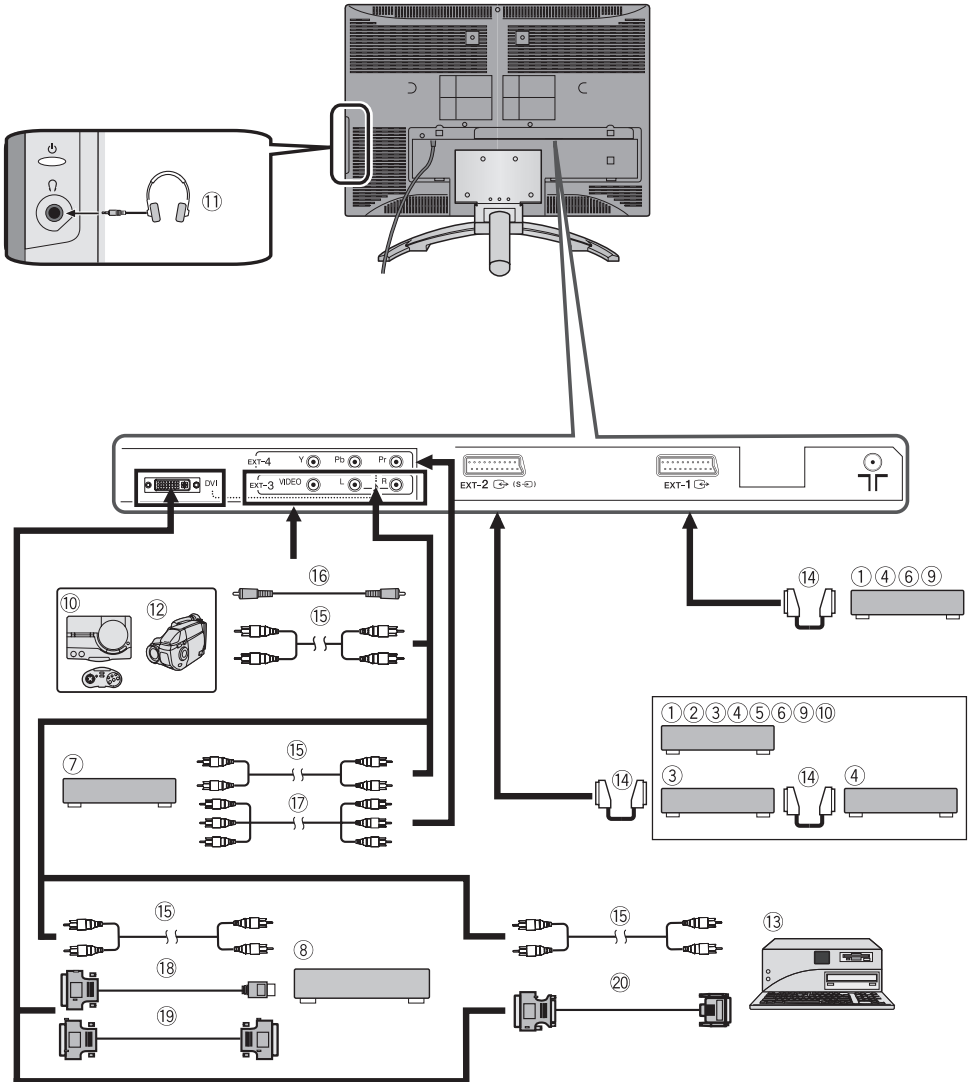

■ **Equipment which can output the S-VIDEO signal (Y/C signal) such as an S-VHS VCR**

Connect the equipment to an EXT-2 terminal. You can choose between an S-VIDEO signal (Y/C signal) and a regular video signal (composite signal). For details of how to operate the equipment, see “S-IN (S-VIDEO input)” on page 37.

■ **T-V LINK compatible VCR**

Be sure to connect the T-V LINK compatible VCR to the EXT-2 terminal. If not, the T-V LINK function will not work properly.

- When connecting a T-V LINK compatible VCR to the EXT-2 terminal, be sure to connect the decoder to the VCR. If not, the T-V LINK function may not work properly.
- When you connect the decoder to the VCR, after you have stored TV channels in the programme numbers (PR) list, set the DECODER (EXT-2) function for the programme number (PR) to ON to unscramble a scrambled TV channel. For details, see “DECODER (EXT-2)” on page 36.

■ **Connecting headphones**

Connect the headphones with a stereo mini-jack (3.5 mm diameter) to the headphone socket at the TV rear panel.

- No sound comes from the TV speakers when the headphones are connected.

■ **Video or sound signal output from the EXT-2 terminal**

You can change over the output of the video/sound signal from the EXT-2 terminal. This is useful when you want to dub the video/sound from another device onto the VCR connected to the EXT-2 terminal. For details on how to do this, see “DUBBING” on page 38.

- The signals from EXT-4 and PC IN terminal cannot be output from EXT-2.

■ **TV output from the EXT-1 terminal**

The video/sound signal of a TV channel you are viewing is always output from the EXT-1 terminal.

- Changing over a programme number (PR) also changes over the TV output from the EXT-1 terminal.
- The video/sound signal from an EXT terminal cannot be output.
- Teletext programmes cannot be output.

■ **Connecting to the computer**

Connect the D-SUB cable with “DVI-I”-“D-SUB” convert adapter from the computer’s analogue RGB output terminal to the DVI terminal on the back of the TV.

If you want to listen to the sound from the computer, use an audio cable to connect the VIDEO-3 AUDIO L/R sound input terminal to the computer’s sound output terminal.

When the sound from the computer is mono, connect to the VIDEO-3 AUDIO L terminal.

To watch images from a computer, start the computer and press the **AV** or **P** \vee/\wedge buttons to choose “PC”.

-
- Refer to the computer’s manual for a detailed explanation of the connections at the computer side.
 - Ensure that the connectors are facing the correct way when connecting.
 - After connecting the D-SUB cable with “DVI-I”-“D-SUB” convert adapter, tighten the two screws to fix the connector in place.
 - Digital output with a DVI cable is not supported.
-

This TV is compatible with the following PC signals.

Resolution	Vertical frequency (Hz)	Horizontal frequency (kHz)
640 × 480 (VGA)	60.0	31.5
1024 × 768 (XGA)	60.0	42.0

- Only the above formats are supported.
- Even with the above formats and at 60 Hz, some problems may be experienced depending on the quality of the synchronous signal. (Depending on the quality, some pictures may not be displayed properly.)
- Apple Macintosh* computers are not supported.

When a picture is not displayed

Check the computer's refresh rate and set it to 60 Hz. Refer to the computer's instruction manual. Computers which cannot have their refresh rate set 60 Hz cannot be used with this unit.

- * Apple Macintosh is a registered trademark of Apple Computer, Inc.

■ Connecting to the HDMI or DVI compatible device

Connect the HDMI-DVI converter cable from the HDMI terminal on the back of your HDMI compatible device to the DVI terminal on the back of the TV and audio cable from the audio output from HDMI compatible device to the VIDEO-3 AUDIO L/R terminal on the back of the TV. To watch the images from a HDMI/DVI compatible device, press the **AV** or **P** \checkmark/\wedge buttons to choose "DVI".

- To connect the DVI compatible device to the DVI terminal, connect the DVI terminal of the DVI compatible device to the DVI terminal of the TV with the DVI cable.
- Ensure that the connectors are facing the correct way when connecting.
- After connecting the DVI-HDMI converter cable or DVI cable, tighten the two screws to fix the connector in place.
- Digital audio output from HDMI terminal is not supported.

The DVI of the TV is compatible with the following video signals.

VGA/60Hz	4:3
480i/60Hz (525i/60Hz)	4:3
480i/60Hz (525i/60Hz)	16:9
480p/60Hz (525p/60Hz)	16:9
576i/50Hz (625i/50Hz)	4:3
576i/50Hz (625i/50Hz)	16:9
576p/50Hz (625p/50Hz)	4:3
576p/50Hz (625p/50Hz)	16:9
720p/50Hz (750p/50Hz)	16:9
720p/60Hz (750p/60Hz)	16:9
1080i/50Hz (1125i/50Hz)	16:9
1080i/60Hz (1125i/60Hz)	16:9

CH/CC numbers

When you want to use the INSERT function on page 35, find the CH/CC number corresponding to the Channel number of the TV channel from this table.

CH	Channel	CH	Channel	CC	Channel	CC	Channel
CH 02 / CH 202	E2, R1	CH 40 / CH 240	E40, R40	CC 01 / CC 201	S1	CC 31 / CC 231	S31
CH 03 / CH 203	E3, ITALY A	CH 41 / CH 241	E41, R41	CC 02 / CC 202	S2	CC 32 / CC 232	S32
CH 04 / CH 204	E4, ITALY B, R2	CH 42 / CH 242	E42, R42	CC 03 / CC 203	S3	CC 33 / CC 233	S33
CH 05 / CH 205	E5, ITALY D, R6	CH 43 / CH 243	E43, R43	CC 04 / CC 204	S4	CC 34 / CC 234	S34
CH 06 / CH 206	E6, ITALY E, R7	CH 44 / CH 244	E44, R44	CC 05 / CC 205	S5	CC 35 / CC 235	S35
CH 07 / CH 207	E7, ITALY F, R8	CH 45 / CH 245	E45, R45	CC 06 / CC 206	S6	CC 36 / CC 236	S36
CH 08 / CH 208	E8, R9	CH 46 / CH 246	E46, R46	CC 07 / CC 207	S7	CC 37 / CC 237	S37
CH 09 / CH 209	E9, ITALY G	CH 47 / CH 247	E47, R47	CC 08 / CC 208	S8	CC 38 / CC 238	S38
CH 10 / CH 210	E10, ITALY H, R10	CH 48 / CH 248	E48, R48	CC 09 / CC 209	S9	CC 39 / CC 239	S39
CH 11 / CH 211	E11, ITALY H+1, R11	CH 49 / CH 249	E49, R49	CC 10 / CC 210	S10	CC 40 / CC 240	S40
CH 12 / CH 212	E12, ITALY H+2, R12	CH 50 / CH 250	E50, R50	CC 11 / CC 211	S11	CC 41 / CC 241	S41
CH 21 / CH 221	E21, R21	CH 51 / CH 251	E51, R51	CC 12 / CC 212	S12	CC 75 / CC 275	X
CH 22 / CH 222	E22, R22	CH 52 / CH 252	E52, R52	CC 13 / CC 213	S13	CC 76 / CC 276	Y, R3
CH 23 / CH 223	E23, R23	CH 53 / CH 253	E53, R53	CC 14 / CC 214	S14	CC 77 / CC 277	Z, ITALY C, R4
CH 24 / CH 224	E24, R24	CH 54 / CH 254	E54, R54	CC 15 / CC 215	S15	CC 78 / CC 278	Z+1, R5
CH 25 / CH 225	E25, R25	CH 55 / CH 255	E55, R55	CC 16 / CC 216	S16	CC 79 / CC 279	Z+2
CH 26 / CH 226	E26, R26	CH 56 / CH 256	E56, R56	CC 17 / CC 217	S17		
CH 27 / CH 227	E27, R27	CH 57 / CH 257	E57, R57	CC 18 / CC 218	S18		
CH 28 / CH 228	E28, R28	CH 58 / CH 258	E58, R58	CC 19 / CC 219	S19		
CH 29 / CH 229	E29, R29	CH 59 / CH 259	E59, R59	CC 20 / CC 220	S20		
CH 30 / CH 230	E30, R30	CH 60 / CH 260	E60, R60	CC 21 / CC 221	S21		
CH 31 / CH 231	E31, R31	CH 61 / CH 261	E61, R61	CC 22 / CC 222	S22		
CH 32 / CH 232	E32, R32	CH 62 / CH 262	E62, R62	CC 23 / CC 223	S23		
CH 33 / CH 233	E33, R33	CH 63 / CH 263	E63, R63	CC 24 / CC 224	S24		
CH 34 / CH 234	E34, R34	CH 64 / CH 264	E64, R64	CC 25 / CC 225	S25		
CH 35 / CH 235	E35, R35	CH 65 / CH 265	E65, R65	CC 26 / CC 226	S26		
CH 36 / CH 236	E36, R36	CH 66 / CH 266	E66, R66	CC 27 / CC 227	S27		
CH 37 / CH 237	E37, R37	CH 67 / CH 267	E67, R67	CC 28 / CC 228	S28		
CH 38 / CH 238	E38, R38	CH 68 / CH 268	E68, R68	CC 29 / CC 229	S29		
CH 39 / CH 239	E39, R39	CH 69 / CH 269	E69, R69	CC 30 / CC 230	S30		

CH	Channel	CH	Channel	CC	Frequency (MHz)	CC	Frequency (MHz)
CH 102	F2	CH 141	F41	CC 110	116 - 124	CC 152	391 - 399
CH 103	F3	CH 142	F42	CC 111	124 - 132	CC 153	399 - 407
CH 104	F4	CH 143	F43	CC 112	132 - 140	CC 154	407 - 415
CH 105	F5	CH 144	F44	CC 113	140 - 148	CC 155	415 - 423
CH 106	F6	CH 145	F45	CC 114	148 - 156	CC 156	423 - 431
CH 107	F7	CH 146	F46	CC 115	156 - 164	CC 157	431 - 439
CH 108	F8	CH 147	F47	CC 116	164 - 172	CC 158	439 - 447
CH 109	F9	CH 148	F48	CC 123	220 - 228	CC 159	447 - 455
CH 110	F10	CH 149	F49	CC 124	228 - 236	CC 160	455 - 463
CH 121	F21	CH 150	F50	CC 125	236 - 244	CC 161	463 - 469
CH 122	F22	CH 151	F51	CC 126	244 - 252		
CH 123	F23	CH 152	F52	CC 127	252 - 260		
CH 124	F24	CH 153	F53	CC 128	260 - 268		
CH 125	F25	CH 154	F54	CC 129	268 - 276		
CH 126	F26	CH 155	F55	CC 130	276 - 284		
CH 127	F27	CH 156	F56	CC 131	284 - 292		
CH 128	F28	CH 157	F57	CC 132	292 - 300		
CH 129	F29	CH 158	F58	CC 133	300 - 306		
CH 130	F30	CH 159	F59	CC 141	306 - 311		
CH 131	F31	CH 160	F60	CC 142	311 - 319		
CH 132	F32	CH 161	F61	CC 143	319 - 327		
CH 133	F33	CH 162	F62	CC 144	327 - 335		
CH 134	F34	CH 163	F63	CC 145	335 - 343		
CH 135	F35	CH 164	F64	CC 146	343 - 351		
CH 136	F36	CH 165	F65	CC 147	351 - 359		
CH 137	F37	CH 166	F66	CC 148	359 - 367		
CH 138	F38	CH 167	F67	CC 149	367 - 375		
CH 139	F39	CH 168	F68	CC 150	375 - 383		
CH 140	F40	CH 169	F69	CC 151	383 - 391		

- When two CH/CC numbers correspond to one Channel number, choose either one according to the current COUNTRY setting. When the COUNTRY setting is other than FRANCE, choose a two-digit CH/CC number. When the COUNTRY setting is FRANCE, choose a three-digit CH/CC number.
 - Find the CH/CC number (CC110 to CC161) corresponding to the TV channel (SECAM-L system) from a French cable TV station, based on the broadcast frequency of the TV channel. When you do not know the broadcast frequency, please contact the cable TV station.
 - The CH/CC numbers of CH102-CH169 and CC110-CC161 correspond to the TV channels being broadcast by a SECAM-L system. The other CH/CC numbers correspond to the TV channels being broadcast by a method other than a SECAM-L system.
-

Troubleshooting

If a problem arises while you are using the TV, please read this troubleshooting guide carefully before you ask to have the TV repaired. You may be able to fix it easily by yourself. For example, if the mains plug is disconnected from the mains outlet, or the TV aerial has problems, you may think there is a problem with the TV itself.

Important:

- This troubleshooting guide only covers problems whose causes are not easy to decide. If you have a question when you are operating a function, read the page(s) for that function carefully, not this troubleshooting guide.
- If you follow the advice in this troubleshooting guide without any success, unplug the mains plug and ask for your TV to be repaired. Do not attempt to repair the TV by yourself or to remove the rear cover of the TV.

■ If you cannot turn on the TV

- Is the mains plug connected to the mains outlet?
- Is the power lamp lit? If not, press the  button on the TV.
- Make sure you set the VCR/TV/DVD switch to the TV position. You cannot turn the TV on when the VCR/TV/DVD switch is set to the VCR or DVD position.

■ If you cannot turn off the TV

- Make sure you set the VCR/TV/DVD switch to the TV position. You cannot turn the TV off when the VCR/TV/DVD switch is set to the VCR or DVD position.

■ No picture or no sound

- Have you chosen a TV channel with very poor reception? If so, the BLUE BACK function will be activated: the entire screen becomes blue, and the sound is muted. If you still want to view the TV channel, follow the description “BLUE BACK” on page 30 to change the BLUE BACK function setting to OFF.
- If the SYSTEM setting for a TV channel is incorrect, it may prevent the sound from being issued. Follow the description “EDIT/MANUAL” on page 32 to use the MANUAL function to try to change the SYSTEM setting.
- When you are using EXT-3, EXT-4 or DVI terminal, make sure the audio cable is connected to EXT-3 L/R terminal.

■ Poor picture

- If noise (snow) totally blocks out the picture, there may be a problem with the aerial or aerial cable. Check the following to try to solve the problem:
 - Have the TV and aerial been connected properly?
 - Has the aerial cable been damaged?
 - Is the aerial pointing in the right direction?
 - Is the aerial itself faulty?
- If the TV or aerial suffers interference from other equipment, stripes or noise may appear in the picture. Move any equipment such as an amplifier, personal computer, or a hair drier, that can cause interference away from your TV. Or try moving the TV. If the aerial suffers interference from a radio tower or high-voltage wire, please contact your local dealer.
- If the TV suffers interference from signals reflecting from mountains or buildings, double-pictures (ghosting) will occur. Try to change the aerial’s direction or replace it with one with better directionality.
- Are your COLOUR SYSTEM settings correct? Follow the description “COLOUR SYSTEM” on page 26 to try to solve the trouble.
- Have the COLOUR and BRIGHT settings been adjusted properly? Follow the description “BRIGHT-2” and “COLOUR” on page 25 to try to adjust them properly.

- Videotaping teletext is not recommended because it may not record correctly.
- When viewing images from commercially available video software products, or videos from videotapes which have been recorded improperly, the top of the image may be distorted. This is due to the condition of the video signal. There is nothing wrong with the TV.
- Since this TV is designed to make full use of the resolution of the original video source, the motion may appear unnatural when the video source is input with progressive-scanning component signals. If this occurs, change the output setting of the connected device to interlace-scanning component signal output. See the instructions that came with the device for more information.

■ Poor sound

- Have you adjusted BASS or TREBLE properly? If not, follow the description “BASS” or “TREBLE” on page 28.
- When TV channel reception is poor, it can be hard to hear stereo or bilingual sound. In this case, follow the description “STEREO / I • II” on page 28 to hear the sound more easily by changing it to a mono sound.

■ If the TV does not respond to the remote control

- Have the batteries of the remote control worn out? Follow the description “Putting the batteries into the remote control” on page 7 and replace them with new batteries.
- Have you attempted to use the remote control from the sides or rear of the TV or from more than seven metres away from the TV? Use the remote control in front of your TV or from less than seven metres away.
- When you are viewing a teletext programme, you cannot operate the menus. Press the **TV** button to return to the ordinary TV programme, and then try operating the menus.
- If the TV suddenly stops responding, disconnect the power cord of the TV from the AC outlet. Connect them to the AC outlet again to turn on the TV. If the TV returns to a normal state, it is not a failure.

■ Other issues

- When the SLEEP TIMER function operates, the TV is automatically turned off. If the TV suddenly turns off, try to press the \odot/I (standby) button to turn on the TV once again. If the TV goes back to normal, there is no problem.
- When the TV is receiving a wide-screen signal (WSS) or a signal from an external device affecting the screen size, the ZOOM mode automatically changes. When you want to resume the previous ZOOM mode, press the **ZOOM** button again.
- It takes a short period of time from the time an operation such as changing channels is performed until an image is displayed. This is not a fault. This is the time needed for the image to stabilize before it can be displayed.
- The TV may make a crackling sound due to a sudden change in temperature. The picture or sound may be normal. If you hear crackling sounds frequently while you are viewing the TV, there may be other causes. As a precaution, ask your service technician to inspect it.

- The top of the TV and the screen may become hot during use but this has no affect on the performance of the TV. Make sure that the ventilation holes are not blocked.
- When the picture is unstable, the screen may become white for a moment. This happens when the signal which drives the liquid crystal is missing. This is not a fault.
- When a still image has been displayed for a long period, a faint residual image may remain on the screen for a short time after the power has been turned off or when another image is displayed. This is not a fault and the image will eventually disappear.

Cable management

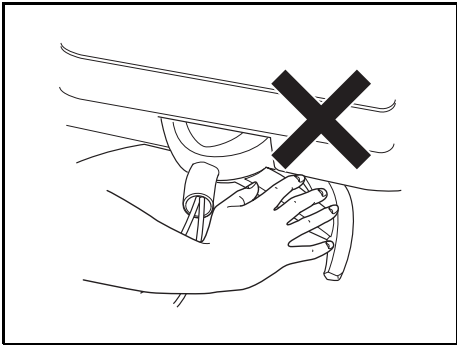
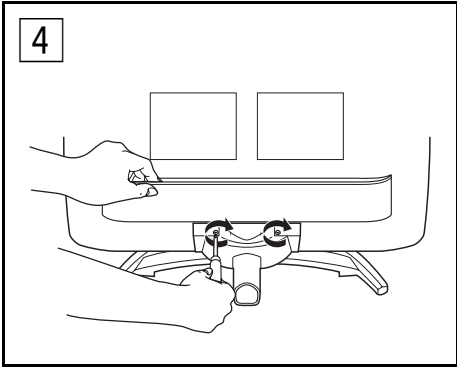
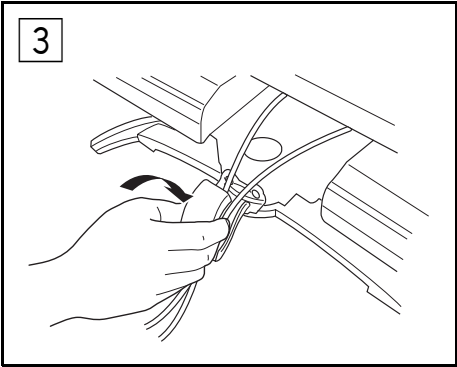
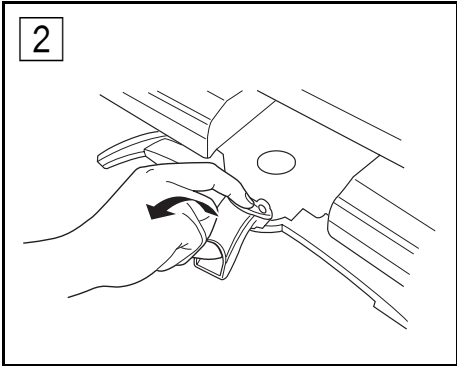
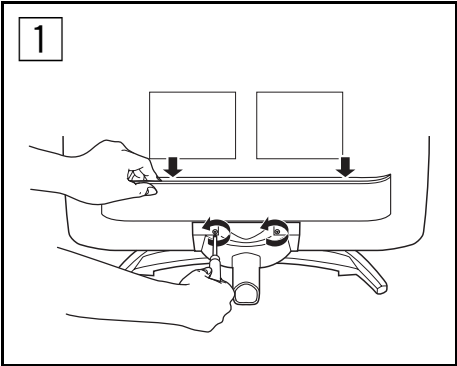

Specifications

Model	LT-32A61BJ/LT-32A61SJ	LT-26A61BJ/LT-26A61SJ
Broadcasting systems	CCIR B/G, I, D/K, L	
Colour systems	PAL, SECAM • The EXT terminals also support the NTSC 3.58/4.43 MHz system.	
Channels and frequencies	F2-F10, F21-F69, 116-172, E2-E12, E21-E69, S1-S41, X, Y, Z, Z+1, Z+2, A-H, H+1, H+2, R1-R12, R21-R69 • French cable TV channel of broadcast frequencies 116 - 172 MHz and 220 - 469 MHz.	
Sound-multiplex systems	NICAM (B/G, I, D/K, L) system, A2 (B/G, D/K) system	
Teletext systems	FLOF (Fastext), TOP, WST (World Standard System)	
Power requirements	110 - 240 V AC, 50/60 Hz	
Screen size	Viewable area 80 cm (measured diagonally)	Viewable area 66 cm (measured diagonally)
Audio output	Rated Power output: 5 W + 5 W	
Speakers	6.6 cm round × 2	
EXT-1 terminal	Euroconnector (21-pin, SCART) • Video input, Audio L/R inputs and RGB inputs are available. • TV broadcast outputs (Video and Audio L/R) are available.	
EXT-2 terminal	Euroconnector (21-pin, SCART) • Video input, S-VIDEO (Y/C) input, Audio L/R inputs and RGB inputs are available. • Video and Audio L/R outputs are available. • T-V LINK functions are available.	
EXT-3 terminal	RCA connectors × 3 • Video input and Audio L/R inputs are available.	
EXT-4 terminal	RCA connectors × 3 + EXT-3 L/R • Component video (Y, Pb, Pr) input and Audio L/R inputs are available. • 625p, 525p, 750p and 1080i signals are available. 750p signal is only available for 60Hz. • Some DVD players can output 625p, 525p, 750p and 1080i signals. • 750p are new high-definition signals.	
DVI terminal	DVI terminal × 1 • Digital video input and PC signal is available. (Refer to page 41 for details).	
Headphone jack	Stereo mini-jack (3.5 mm in diameter)	
Dimensions (W × H × D)	820 mm × 602 mm × 269 mm 820 mm × 551 mm × 126.8 mm (without stand)	686 mm × 525 mm × 269 mm 686 mm × 474 mm × 121.5 mm (without stand)
Weight	18.1 kg 15.5 kg (without stand)	14.9 kg 12.3 kg (without stand)
Accessories	Remote control unit × 1 (RM-C1816S) AA/R6 dry cell battery × 2	

We may change the design and specifications without notice.

Pictures displayed on the screen using this TV's ZOOM functions should not be shown for any commercial or demonstration purpose in public places (cafes, hotels, etc.) without the consent of the owners of copyright of the original picture sources, as this would be an infringement of copyright.

JVC

JVC



ENGLISH
DEUTSCH
FRANÇAIS
NEDERLANDS
CASTELLANO
ITALIANO
PORTUGUÊS

InteriArt

LT-32A61BU

LT-32A61SU

LT-26A61BU

LT-26A61SU

HD
ready

T-V LINK

WIDE LCD PANEL TV

INSTRUCTIONS

16:9 LCD TV

BEDIENUNGSANLEITUNG

TELEVISEUR A ECRAN LCD PANORAMIQUE

MANUEL D'INSTRUCTIONS

BREEDBEELD LCD TV

GEBRUIKSAANWIJZING

TELEVISOR CON PANEL LCD PANORÁMICO

MANUAL DE INSTRUCCIONES

TV LCD WIDESCREEN

ISTRUZIONI

**TELEVISOR COM ECRÃ PANORÂMICO DE
CRISTAL LÍQUIDO**

INSTRUÇÕES



Thank you for buying this JVC LCD flat television.
To make sure you understand how to use your new TV, please read this manual thoroughly before you begin. ("LCD" stands for Liquid Crystal Display.)

WARNING: TO PREVENT FIRE OR SHOCK HAZARD, DO NOT EXPOSE THIS APPLIANCE TO RAIN OR MOISTURE.

WARNING

- The TV may fall causing injuries. Hold the bottom of the stand with your hand and tilt the TV up and down.
- Do not allow children to hang from the TV, place their elbows on the TV or lean against the TV. Doing so may cause the TV to fall over and lead to injuries.

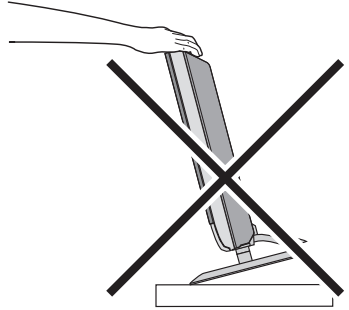

CAUTION

- The TV screen may be damaged if the TV is carried as shown in the diagram below.
The TV should always be carried by two people.

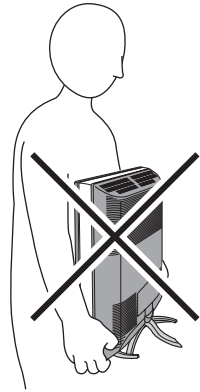

Pixel defects

LCDs use collections of fine points ("pixels") to display images. While there is no problem with more than 99.99% of these pixels, please understand that a very small number of pixels may not light, or may light all the time.

Distance recommendations

Avoid improper installation and never position the unit where good ventilation is impossible. When installing this TV, distance recommendations must be maintained between the set and the wall, as well as inside a tightly enclosed area or piece of furniture. Keep to the minimum distance guidelines shown for safe operation.

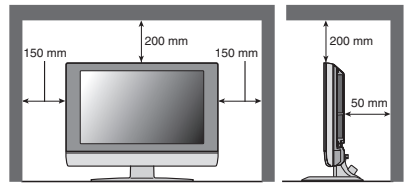

Failure to take the following precautions may cause damage to the television or remote control.

DO NOT block the TV's ventilation openings or holes.

(If the ventilation openings or holes are blocked by a newspaper or cloth, etc., the heat may not be able to get out.)

DO NOT place anything on top of the TV.

(such as cosmetics or medicines, flower vases, potted plants, cups, etc.)

DO NOT allow objects or liquid into the cabinet openings.

(If water or liquid is allowed to enter this equipment, fire or electric shock may be caused.)

DO NOT place any naked flame sources, such as lighted candles, on the TV.

DO NOT subject the TV to direct sunlight.

The surface of the TV screen is easily damaged. Be very careful with it when handling the TV. Should the TV screen become soiled, wipe it with a soft dry cloth. Never rub it forcefully. Never use any cleaner or detergent on it.

If there is a fault, unplug the unit and call a service technician. Do not attempt to repair it yourself or remove the rear cover.

■ Cleaning the screen

The screen is coated with a special thin film to reduce reflection. If this film is damaged, uneven colors, discoloration, scratches, and other problems that cannot be repaired may occur. Pay attention to the following when handling the screen.

- Do not use glue or adhesive tape on the screen.
- Do not write on the screen.
- Do not allow the screen to come in contact with any hard objects.
- Do not allow condensation to form on the screen.
- Do not use alcohol, thinner, benzene or other solvents on the screen.
- Do not rub the screen hard.

CAUTION:

- Operate only from the power source specified (AC 110 – 240 V, 50/60 Hz) on the unit.
 - Avoid damaging the AC plug and power cord.
 - When you are not using this unit for a long period of time, it is recommended that you disconnect the power cord from the main outlet.
-

CONTENTS

Setting up your TV	4	PICTURE menu	25
Installation	4	PICTURE MODE	25
Using the stand	4	BRIGHT-1	25
Removing the terminal cover	5	CONTRAST	25
Connecting the aerial and video cassette recorder (VCR)	6	BRIGHT-2	25
Connecting the power cord to the AC outlet	7	SHARP	25
Putting the batteries into the remote control	7	COLOUR	25
Initial settings	7	HUE	25
T-V LINK functions	10	COLOUR TEMP	25
TV buttons and functions	12	FEATURES	26
Turn the TV on from standby mode	12	SOUND menu	28
Choose a TV channel	12	STEREO / I • II	28
Watch images from external devices	12	BASS	28
Adjust the volume	13	TREBLE	28
Using the Menu	13	BALANCE	28
Remote control buttons and functions	14	3D SOUND	28
Turn the TV on or off from standby mode	14	FEATURES menu	29
Choose a TV channel and watch images from external devices	15	SLEEP TIMER	29
Adjust the volume	16	CHILD LOCK	29
Information function	16	APPEARANCE	30
ZOOM function	17	BLUE BACK	30
3D SOUND function	18	FAVOURITE SETTING	31
Return to TV channel instantly	18	SET UP menu	32
Favourite channel function	19	AUTO PROGRAM	32
Operating a JVC brand VCR or DVD player	20	EDIT/MANUAL	32
Teletext function	21	LANGUAGE	36
Basic operation	21	DECODER (EXT-2)	36
Using the List Mode	21	EXT SETTING	37
Hold	22	Additional preparation	40
Sub-page	22	Connecting external equipment	40
Reveal	22	CH/CC numbers	44
Size	22	Troubleshooting	46
Index	23	Cable management	49
Cancel	23	Specifications	50
Using the TV's menu	24		
Basic operation	24		

Setting up your TV

- When you install the TV on the wall, only use a JVC wall mounting unit (optional) which is designed for this TV.
- Make sure that the TV is installed on the wall by a skilled installer.

Installation

Cautions for installation

- Install the TV in a corner on a wall or on the floor so as to keep cords out of the way.
- The TV will generate a slight amount of heat during operation. Ensure that sufficient space is available around the TV to allow satisfactory cooling. See “Distance recommendations” on page 1.

Using the stand

This TV comes with a table top stand already attached.

This stand can be used to adjust the direction of the TV screen to the left or right.

■ Rotate the TV to the left and right:

While holding the bottom of the stand with one hand, use your other hand to hold the edge of the panel and slowly adjust the direction of the TV screen.

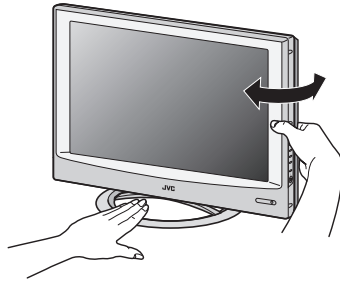

Removing the terminal cover

There are connection terminals behind the cover on the rear of the TV. Remove the cover before connecting an antenna or VCR.

Remove the cover by removing the hooks.
When replacing the cover, place the side of the cover against the TV and insert the hooks.

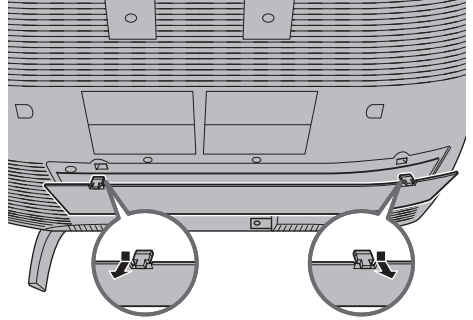

-
- Leave the cover off if they do not fit properly. Do not force to replace the cover. Doing so may cause damage to the connection cables and the cover.
-

Connecting the aerial and video cassette recorder (VCR)

- The connecting cables are not provided.
- For further details, refer to the manuals provided with the devices to be connected.

Caution

- Turn off all the equipment including the TV before connecting anything.

■ If you are connecting a VCR, follow ① → ② → ③ in the diagram opposite.

■ If you are not connecting a VCR, follow ①.

To use the T-V LINK functions, you must have a T-V LINK compatible VCR connected by a SCART cable ③ to the EXT-2 terminal on the TV. For details about T-V LINK functions, see “T-V LINK functions” on page 10.

- You can watch a video using the VCR without doing ③. For details, see your VCR instruction manual.
- To connect more equipment, please see “Connecting external equipment” on page 40.
- If you connect a decoder to a T-V LINK compatible VCR, set the DECODER (EXT-2) function to ON. For details, see “DECODER (EXT-2)” on page 36. Otherwise, you will not be able to watch scrambled channels.

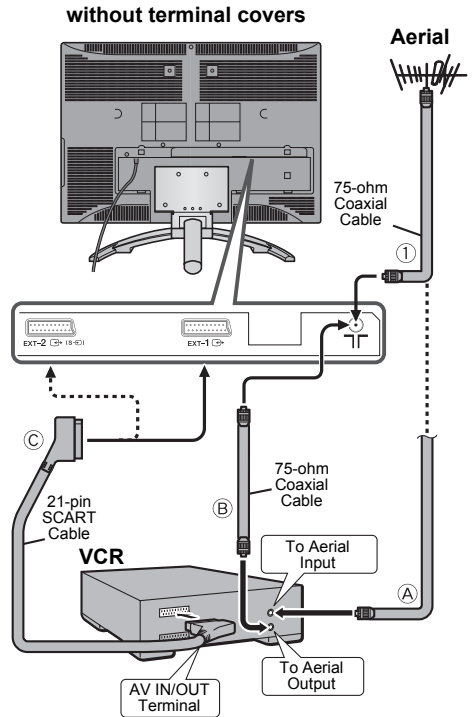

Connecting the power cord to the AC outlet

Insert the AC plug on the power cord from the TV into an AC outlet.

Caution

- Operate only from the power source specified (AC 110 – 240 V, 50/60 Hz) on the unit.
- Remove the AC plug from the outlet to completely disconnect the TV from the power supply.

Putting the batteries into the remote control

Use two AA/R6 dry cell batteries. Insert the batteries from the \ominus end, making sure the \oplus and \ominus polarities are correct.

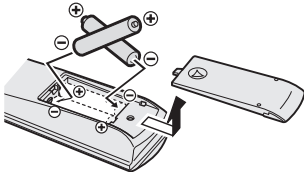

- Follow the warnings printed on the batteries.
- Battery life is about six months to one year, depending on how much you use the remote control.
- The batteries we supply are only for setting up and testing your TV, please replace them as soon as you need to.
- If the remote control does not work properly, replace the batteries.

Initial settings

When the TV is first turned on, it goes into the initial settings mode, and you will see the JVC logo. Follow the instructions on the screen display to make the initial settings.

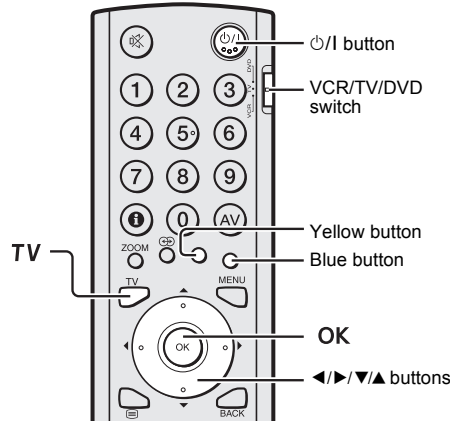

1 Make sure to set the VCR/TV/DVD switch on the remote control to the TV position

- You cannot turn the TV on when the VCR/TV/DVD switch is set to the VCR or DVD position.

2 Press the ⏻ button on the remote control

The TV turns on from standby mode and the JVC logo is displayed.

- Check that the AC plug on the power cord from the TV is connected to AC outlet.

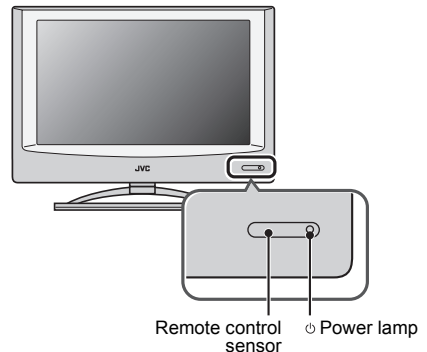

- If the JVC logo does not appear this is because your TV has already been turned on for the first time: use the “LANGUAGE” and “AUTO PROGRAM” functions to make the initial settings. For details, see “SET UP menu” on page 32.

3 Press the OK button

The LANGUAGE menu appears.

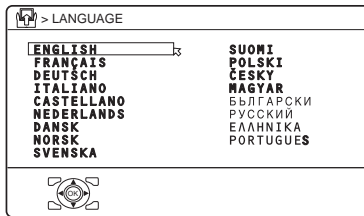

D0002(E)-EN

4 Press the ▼/▲ buttons to choose ENGLISH. Then press the OK button

The on-screen display will then be in English. The COUNTRY menu appears as a sub-menu of the AUTO PROGRAM function. There are two COUNTRY menus. Pressing the yellow button changes the COUNTRY menu as follows:

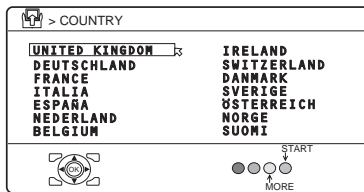

D0003-EN

5 Press the ◀/▶ and ▼/▲ buttons to choose the country where you are

6 Press the blue button to start the AUTO PROGRAM function

The AUTO PROGRAM menu appears and received TV channels are automatically stored in the programme numbers (PR).

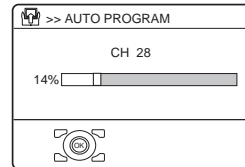

D0004-EN

- To cancel the AUTO PROGRAM function: Press the OK button.



After the TV channels have been registered in the programme numbers (PR), the EDIT menu appears

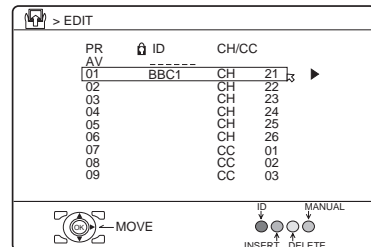

D0038-EN

- If you want to, you can now edit the programme numbers (PR) using the EDIT/MANUAL function. For details, see “EDIT/MANUAL” on page 32.
- If you do not want to edit programme numbers (PR), go to the next step.

7 Press the **OK** button to display the **T-V LINK** menu

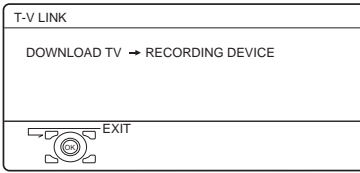

D0005-EN

If you do not have a **T-V LINK** compatible **VCR** connected:

Press the **TV** button to exit the T-V LINK menu.

The T-V LINK menu disappears.

If you have a **T-V LINK** compatible **VCR** connected to the **EXT-2** terminal:

Follow the operating procedure “Downloading the data to VCR” on page 10 to transmit the Programme number (PR) data.

Now, the initial settings are complete, and you can watch the TV

- If your TV can detect the TV channel name from the TV channel broadcast signal, the TV channel name is assigned to the programme number (PR) to which the TV channel has been set. However, which TV channels are set to which programme numbers (PR) will depend on the area in which you live.
- If a TV channel you want to view is not set to a programme number (PR), you can set it using the **MANUAL** function. For details, see “**EDIT/MANUAL**” on page 32.
- The **AUTO PROGRAM** function does not set the programme number PR 0 (AV) for your video cassette recorder. You will need to set this using the **MANUAL** function.

■ **Downloading the data to VCR**

You can transmit to the latest Programme numbers (PR) data to a VCR with the T-V LINK function.

Caution

- This only works when a T-V LINK compatible VCR is connected to the EXT-2 terminal.
- This only works when the T-V LINK menu is being displayed.

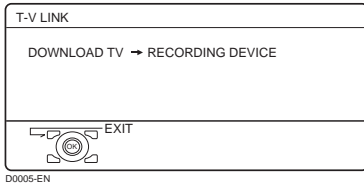

1 Turn on the VCR

2 Press the OK button

The data transmission begins.

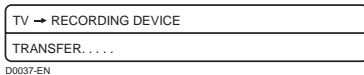

The T-V LINK menu disappears once the data transmission ends.

When the T-V LINK menu is changed over to another menu:

The TV has finished its menu. This new menu is operated from the VCR. See the VCR instruction manual for what to do next.

If “FEATURE NOT AVAILABLE” appears at the T-V LINK menu:

Check the following three items. Then press the ◀ button to retry data transmission.

- Has a T-V LINK compatible VCR been connected to the EXT-2 terminal?
- Has the VCR power been turned on?
- Does the SCART cable that is connected to the EXT-2 terminal to T-V LINK compatible VCR have all its proper connections?

T-V LINK functions

When you have a T-V LINK compatible VCR connected to the EXT-2 Terminal on the TV, it is easier to set up the VCR and to view videos. T-V LINK uses the following features:

To use T-V LINK functions:

A “T-V LINK compatible VCR” means a JVC video cassette recorder with the T-V LINK logo, or with one of the following logos. However, these VCRs may support some or all of the features described earlier. For details, see your VCR instruction manual.

- “Q-LINK” (a trademark of Panasonic Corporation)
- “Data Logic” (a trademark of Metz Corporation)
- “Easy Link” (a trademark of Phillips Corporation)
- “Megalogic” (a trademark of Grundig Corporation)
- “SMARTLINK” (a trademark of Sony Corporation).

■ Pre-set download

The VCR will automatically download the registered data on the TV channels from the TV. This means you do not need to set up the program channels on your VCR manually. The preset download function automatically begins when the initial setting is complete or whenever you carry out the AUTO PROGRAM or EDIT/MANUAL functions. You can also carry out this function using your VCR controls.

When “FEATURE NOT AVAILABLE” is displayed:

If “FEATURE NOT AVAILABLE” is displayed, the download was not performed correctly. Before trying to download again, check that:

- the VCR power is turned on
- the VCR is T-V LINK compatible
- the VCR is connected to the EXT-2 terminal
- the SCART cable is fully wired.

■ Direct Rec

“What You See Is What You Record”

You can easily record to VCR the images that you are watching on the TV.

For details, read the manual for your VCR. Use your VCR controls. “DEVICE IS RECORDING” is displayed.

In the following situations, the VCR will stop recording if the TV is turned off, if the TV channel or input is changed, or if the menu is displayed on the TV:

- when recording images from an external device connected to the TV (for example a camcorder)
- when recording a TV channel after it has been unscrambled on a decoder
- when recording a TV channel by using the TV’s output because the VCR’s own tuner cannot properly receive that channel.

You cannot carry out Direct Rec using your TV’s control.

Generally, the VCR cannot record a TV channel that it cannot receive properly on its own tuner, even if you can view that TV channel on the TV. However, some VCRs can record a TV channel by using the TV’s output if that channel can be viewed on the TV. For details, see your VCR instruction manual.

When the VCR is not ready, the following messages are displayed.

ERROR MESSAGE	Cause and countermeasure
NO RECORDING	The VCR is not able to record. Check the VCR.
NO RECORDING POSSIBLE	The TV input is set to EXT-4 or PC. Since the EXT-4 picture or PC picture cannot be output to EXT-2, DIRECT REC is not possible.
NO RECORDING, MEDIA PROBLEM	The recording device is not ready to record. Check the VCR tape.
NO RECORDING, DEVICE BUSY	The recording device cannot record as it is recording or playing. Check the VCR.

Refer to the VCR instruction manual.

TV buttons and functions

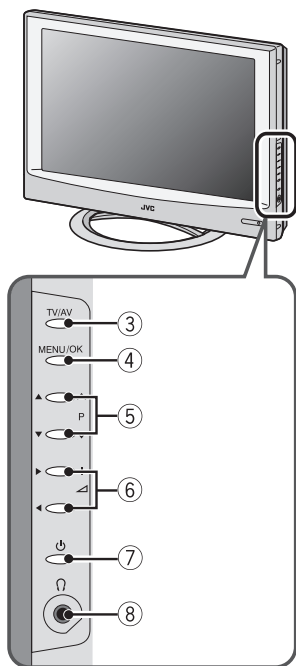
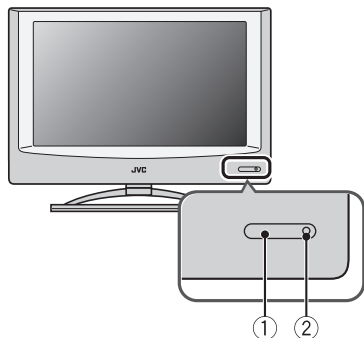

Refer to the pages in parentheses for details.

- ① Remote control sensor
- ② Power lamp (page 7)
- ③ TV/AV button (page 12)
- ④ MENU/OK button (pages 13, 24)
- ⑤ P ∇/Δ buttons (page 12)
- ⑥ ∇/Δ (Volume) $-/+$ buttons (page 13)
- ⑦ \odot (Stand by) button (page 12)
- ⑧ Headphone jack (mini jack) (page 40)

Turn the TV on from standby mode

Press the \odot button or the P ∇/Δ buttons to turn the TV on from standby mode.

When the TV is turned on, the power lamp lights blue.

To turn the TV off:

Press the \odot button again.
The power lamp goes off.

Caution

- The \odot button on the TV does not fully isolate the TV from the AC supply. If you are not going to use the TV for a long period, be sure to disconnect the AC plug from the AC socket.

Choose a TV channel

Press the P ∇/Δ buttons to choose a programme number (PR) or an EXT terminal

Watch images from external devices

Press the TV/AV button to choose an EXT terminal

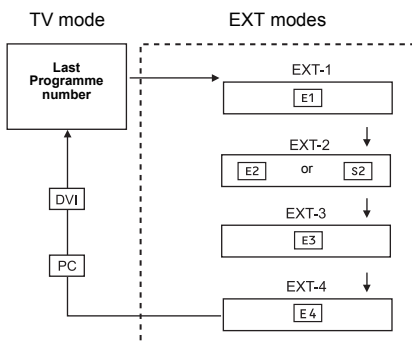

Adjust the volume

Press the  (Volume) -/+ buttons

The volume level indicator appears.

Using the Menu

Use the MENU/OK button

Refer to “Using the TV’s menu” (see page 24) for details of using the menu.

Remote control buttons and functions

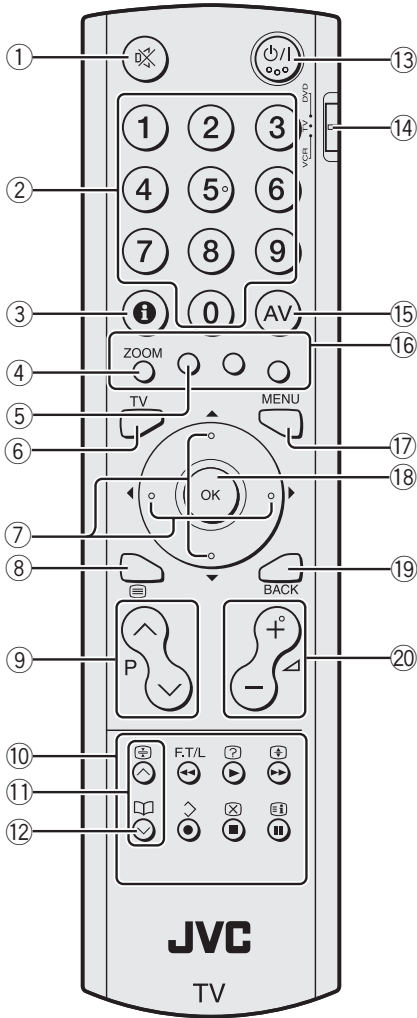

- ① Muting button
- ② Number buttons
- ③ Information button
- ④ **ZOOM** button
- ⑤ ↻ button
- ⑥ **TV** button
- ⑦ ◀/▶/▼/▲ buttons
- ⑧ ≡ (Text) button
- ⑨ **P** ∨/∧ buttons
- ⑩ VCR/DVD/Teletext control buttons
- ⑪ ∨/∧ buttons
- ⑫ 📖 (Favourite) button
- ⑬ ⏻/⏼ (Standby) button
- ⑭ VCR/TV/DVD switch
- ⑮ **AV** button
- ⑯ Colour buttons
- ⑰ **MENU** button
- ⑱ **OK** button
- ⑲ **BACK** button
- ⑳ ◀ (Volume) -/+ buttons

Turn the TV on or off from standby mode

Press the ⏻/⏼ (standby) button to turn the TV on or off

When the TV is turned on, the power lamp lights blue.

- The power can be turned on by pressing the **TV** button, **P** ∨/∧ buttons or Number buttons.

To turn the TV on or off, set the VCR/TV/DVD switch on the remote control to the TV position and press the ⏻/⏼ button. If the VCR/TV/DVD switch on the remote control is set to a position other than TV, the TV will not be turned on or off even if the ⏻/⏼ button is pressed.

Choose a TV channel and watch images from external devices

■ Use the number buttons:

Enter the programme number (PR) of the channel using the number buttons.

Example:

- PR 6 → press **6**
- PR 12 → press **1** and **2**

■ Use the P ∇/\blacktriangle buttons:

Press the P ∇/\blacktriangle buttons to choose the programme number (PR) you want or an EXT terminal.

■ Use the AV button:

Press the AV button to choose an EXT terminal.

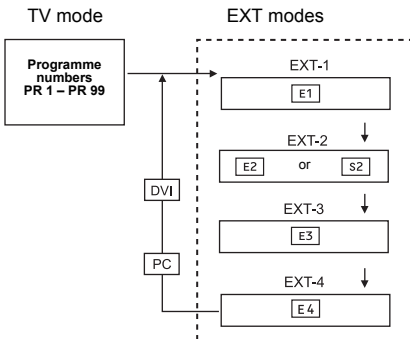

- You can choose a video input signal from the S-VIDEO signal (Y/C signal) and regular video signal (composite signal). For details, see “S-IN (S-VIDEO input)” on page 37.
- If you do not have a clear picture or no colour appears, change the colour system manually. See “COLOUR SYSTEM” on page 26.
- If you choose an EXT terminal with no input signal, the EXT terminal number becomes fixed on the screen.

- Since this TV is designed to make full use of the resolution of the original video source, the motion may appear unnatural when the video source is input with progressive-scanning component signals. If this happens, change the output setting of the connected device to interlace-scanning component signal output. See the instructions that came with the device for more information.
- The PC sound is the same as the EXT-3 sound.

To return to a TV channel:

Press the **TV** button, the ∇/\blacktriangle buttons or the number buttons.

To use the programme number PR 0 (AV):

When the TV and VCR are connected only by the aerial cable, choosing the programme number PR 0 (AV) allows you to view images from the VCR. Set the VCR RF channel to the programme number PR 0 (AV) manually. For details, see “EDIT/MANUAL” on page 32.

Pressing the **AV** button changes the choice as follows:

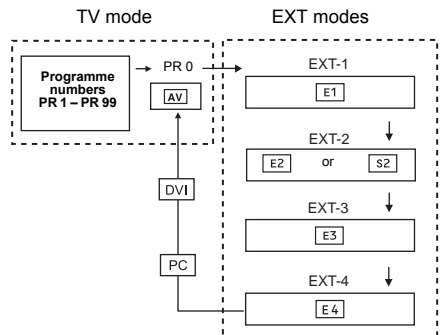

- The VCR sends its playback image along the aerial cable as an RF (radio frequency) signal.
- Also see your VCR instruction manual.

Adjust the volume

Press the buttons to adjust the volume.

The volume level indicator appears and the volume changes as you press the buttons.

■ Muting the sound

Press the (muting) button to turn off the sound.

Pressing the (muting) button again restores the previous volume level.

Information function

You can see the channel number of the programme you are watching, the current time or the PR LIST.

From the PR LIST, you can choose a channel or EXT terminal.

Press the (Information) button to display the information you want to see.

Pressing the (Information) button changes the display as follows:

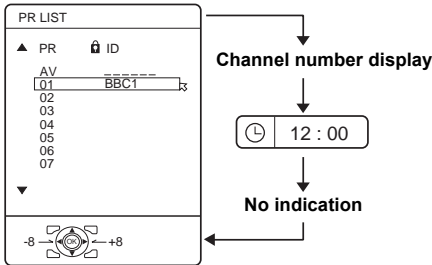

Channel number display:

The channel number and channel name (when the channel name is registered) of the programme you are watching or the EXT terminal number is displayed.

Time display:

The current time of the teletext data is displayed.

If the TV has not received a TV channel that has teletext programmes since it was turned on, the time display is blank. To view the current time, choose a TV channel that has teletext programmes.

- An incorrect current time is sometimes displayed when watching videos.

PR LIST:

The programme number (PR) and EXT terminal list is displayed.

Pressing the **OK** button after choosing the programme number (PR) or EXT terminal with the buttons will display the chosen programme or EXT terminal.

- For programme numbers (PR) for which the CHILD LOCK function is set, the (CHILD LOCK) mark is displayed. For details see “CHILD LOCK” on page 29.
- For programme numbers (PR) which is registered as a favourite channel, the (favourite) mark is displayed. For details see “Favourite channel function” on page 19.

ZOOM function

You can change the screen size according to the picture aspect ratio. Choose the optimum one from the following ZOOM modes.

- The ZOOM mode is fixed at FULL when you are using the TV as a PC screen.

AUTO:

When a WSS (Wide Screen Signalling) signal, which shows the aspect ratio of the picture, is included in the broadcast signal or the signal from an external device, the TV automatically changes the ZOOM mode to 16:9 ZOOM mode or FULL mode according to the WSS signal.

If a WSS signal is not included, the picture is displayed according to the ZOOM mode set with the 4:3 AUTO ASPECT function.

- For details of the 4:3 AUTO ASPECT function, see “4:3 AUTO ASPECT” on page 27.
- When the AUTO (WSS) mode does not function correctly due to poor WSS signal quality or when you want to change the ZOOM mode, press the **ZOOM** button and change to another ZOOM mode.

REGULAR:

Use to view a normal picture (4:3 aspect ratio) as this is its original shape.



PANORAMIC:

This stretches the left and right sides of a normal picture (4:3 aspect ratio) to fill the screen, without making the picture appear unnatural.

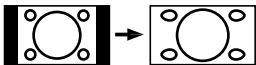

- The top and bottom of the picture are slightly cut off.

14:9 ZOOM:

This zooms up the wide picture (14:9 aspect ratio) to the upper and lower limits of the screen.



16:9 ZOOM:

This zooms up the wide picture (16:9 aspect ratio) to the full screen.

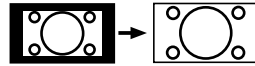

16:9 ZOOM SUBTITLE:

This zooms up the wide picture (16:9 aspect ratio) with subtitles to the full screen.

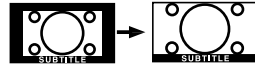

FULL:

This uniformly stretches the left and right sides of a normal picture (4:3 aspect ratio) to fill the wide TV screen.

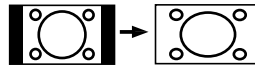

- For 16:9 aspect ratio pictures that have been squeezed into a normal picture (4:3 aspect ratio), use the FULL mode to restore the picture to its original shape.

■ Choose the ZOOM mode

1 Press the **ZOOM** button to display the ZOOM menu

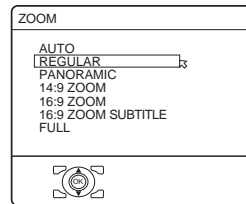

D0009-EN

2 Press the **▼/▲** buttons to choose a ZOOM mode. Then press the **OK** button

The picture expands and the chosen ZOOM mode is displayed in about 5 seconds.

- The ZOOM mode may be automatically changed by the control signal from an external device. When you want to return to the previous ZOOM mode, choose the ZOOM mode again.

■ **Adjusting the visible area of the picture**

If subtitles or the top (or bottom) of the picture are cut off, you can adjust the visible area of the picture manually.

1 Press the ZOOM button

The ZOOM menu appears.

2 Press the OK button to display the ZOOM mode indicator

The indicator appears.



3 While it is displayed, press the ▼/▲ buttons to change the position of the picture

- You cannot adjust the visible area in REGULAR or FULL mode.

The visible area adjustment is saved even after the TV channel is changed. However, it is cancelled if the following operations are performed.

- The power is turned off/on
 - The ZOOM mode is changed
 - [Text] (Text) button is pressed
 - The TV is switched between TV mode and EXT mode
-

3D SOUND function

You can enjoy sounds with a wider ambience.

- This function does not work for the sound from headphones.

Press the [3D] button to select one of 3D SOUND modes

ON:

When you listen to stereo sound, please select ON mode.

You can enjoy sound similar to the experience at the theatre.

MONO:

Select the MONO mode, when you listen to the mono sound.

You can enjoy the sound for a wider audience similar to stereo sound.

OFF:

The 3D SOUND function switches off.

-
- You can choose the 3D SOUND mode with the “SOUND menu” (see page 28).
-

Return to TV channel instantly

You can return to a TV channel instantly.

Press the TV button

The TV returns to the TV mode and a TV channel appears.

Favourite channel function

You can register your favourite TV channels (PR 1 – PR 99) in the number buttons 1 to 4. After registering, the channel can be called by pressing the  (favourite) button and a number button 1 to 4.

■ Favourite channel registration

1 In the normal screen, choose a TV channel (PR 1 – PR 99) that you want to register

For details, refer to “Choose a TV channel and watch images from external devices” on page 15.

2 Press and hold the (favourite) button for three seconds or more

Then “SET 1-4?” appears on the screen.

3 Press one of the number buttons 1 to 4

The current channel is registered in the pressed number button. After “PROGRAMMED!” appears on the screen, the favourite channel icon appears at the top-right of the screen.

- If the channel you are trying to register is already registered in one of the other number buttons 1 to 4, “NOT AVAILABLE” appears on the screen.
 - Channels locked with the CHILD LOCK function cannot be registered.
 - If AUTO PROGRAM is performed, the registered favourite channels are reset.
-
- When you want to delete a favourite channel, delete the set channel and set contents with FAVOURITE SETTING (see page 31) in the FEATURES menu.
-

■ Calling the favourite channel

1 In the normal screen, press the (favourite) button

Then “FAVORITE1-4?” appears.

2 Press one of the number buttons 1 to 4

The called favourite channel appears on the screen.

- If a number button in which no channel is registered is pressed, “NO MEMORY” appears on the screen.

■ Setting the picture effect

When a favourite channel has been chosen with the  (favourite) button and number buttons 1 to 4, picture effect settings can be memorised for each favourite channel by setting the picture effects in the PICTURE menu (see page 25).

The following items in the PICTURE menu (see page 25) are memorised.

PICTURE MODE
 BRIGHT-1
 CONTRAST
 BRIGHT-2
 SHARP
 COLOUR
 HUE
 COLOUR TEMP.
 DIGITAL VNR
 COLOUR SYSTEM

The last setting made for each item is memorised.

Operating a JVC brand VCR or DVD player

These buttons will operate a JVC brand VCR or DVD player. Pressing a button that looks the same as the device's original remote control button has the same effect as the original remote control.

1 Set the VCR/TV/DVD Switch to the VCR or DVD position

VCR:

When you are operating the VCR, set the switch to the VCR position.

- You can turn the VCR on or off with the $\odot/|$ (standby) button.

DVD:

When you are operating the DVD player, set the switch to the DVD position.

- You can turn the DVD player on or off with the $\odot/|$ (standby) button.
- You can also press the **MENU** or **TOP MENU** button and display the DVD disc menu screen, and then operate by pressing the $\blacktriangleleft/\blacktriangleright/\blacktriangledown/\blacktriangleup$ buttons.

2 Press the VCR/DVD Control Button to control your VCR or DVD player

- If your device is not made by JVC, these buttons will not work.
- Even if your device is made by JVC, some of these buttons may not work, depending on the device you are using.
- You can use the \vee/\wedge buttons to choose a TV channel the VCR will receive, or choose the chapter the DVD player plays back.
- Some models of DVD player use the \vee/\wedge buttons for both operating the fast forward/backward functions and for choosing the chapter. In this case, the $\blacktriangleleft/\blacktriangleright$ buttons do not work.

You cannot turn the TV on or off when the VCR/TV/DVD switch is set to the VCR or DVD position.

When you turn the TV on or off, set the VCR/TV/DVD switch to the TV position.

Teletext function

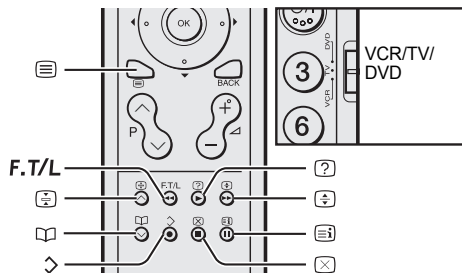

Basic operation

- 1 Choose a TV channel with a teletext broadcast
- 2 Set the VCR/TV/DVD switch to the TV position



- 3 Press  (Text) button to display the teletext

Pressing  (Text) button changes the mode as follows:

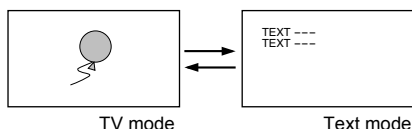

- 4 Choose a teletext page by pressing the **P**    buttons, number buttons or colour buttons

To return to the TV mode:

Press the **TV** button or  (Text) button.

- If you have trouble receiving teletext broadcasts, consult your local dealer or the teletext station.
- The ZOOM function will not work in the TV and text mode or Text mode.
- You cannot operate menus when viewing a teletext programme.
- Language display depends on the country which was set on the COUNTRY menu. If characters on a Teletext programme do not appear properly, change the COUNTRY setting to other country's. To change the COUNTRY setting, perform steps 1 and 2 of the "AUTO PROGRAM" procedure on page 32 and then press the **OK** button.

Using the List Mode

You can store the numbers of your favourite teletext pages in memory and call them up quickly using the colour buttons.

- **To store the page numbers:**

- 1 Press **F.T/L** button to go into the **List mode**

The page numbers you have stored are displayed at the bottom of the screen.

- 2 Press a colour button to choose a position. Then press the number buttons to enter the page number**

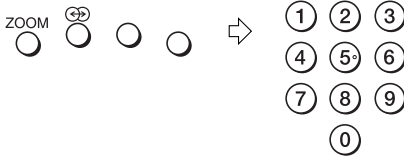

- 3 Press and hold down the \diamond (Store) button**

The four page numbers blink white to show that they are stored in memory.

■ To call up a stored page:

- 1 Press the F.T/L button to enter the List mode**

- 2 Press a colour button having a stored page**

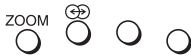

To exit the List mode:
Press the F.T/L button again.

Hold

You can hold a teletext page on the screen for as long as you want, even while several other teletext pages are being received.

- Press the \square (Hold) button**

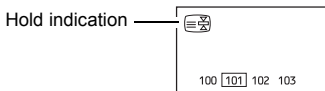

To cancel the Hold function:
Press \square (Hold) button again.

Sub-page

Some teletext pages include sub-pages that are automatically displayed. You can hold any sub-page, or view it at any time.

- 1 Press the \square (Favourite) button to operate the Sub-page function**

- 2 Press the Number buttons to enter a sub-page number**

Example:

- 3rd sub-page \rightarrow press **0, 0, 0** and **3**.

To cancel the Sub-page function:

Press the \square (Favourite) button again.

Reveal

Some teletext pages include hidden text (such as answers to a quiz). You can display the hidden text.

- Each time you press the \square (Reveal) button, text is hidden or revealed**

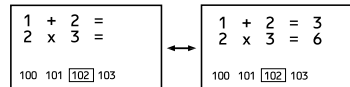

Size

You can double the height of the teletext display.

- Press the \square (Size) button**

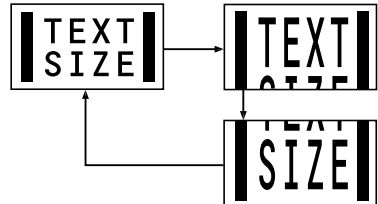

Index

You can return to the index page instantly.

Press the (Index) button

Returns to page 100 or a previously specified page.

Cancel

You can search for a teletext page while watching TV.

1 Press the number button to enter a page number, or press a colour button

The TV searches for a teletext page.

2 Press (Cancel) button

The TV programme appears. When the TV finds the teletext page, its page number appears in the upper left of the screen.

3 Press (Cancel) button to return to a teletext page when the page number is on the screen

- The TV mode cannot be resumed by pressing the  (Cancel) button. To return to the TV mode press **TV**.

Using the TV's menu

This TV has a number of functions you can operate using menus. To use all your TV's functions, you need to understand the basic menu operating techniques fully.

Buttons used to operate the menus

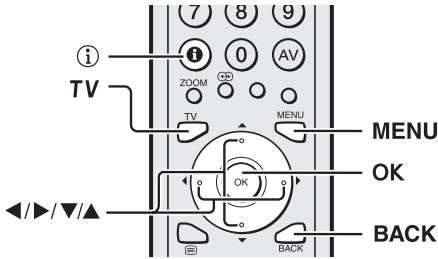

Types of menu



D0106

PICTURE menu

Choose to set the screen settings.



D0107

SOUND menu

Choose to set the sound settings.



D0108

FEATURES menu

Choose to set the sleep timer and child lock settings.



D0109

SET UP menu

Choose to edit the channels or set the display language settings.

Basic operation

- 1 Press the **MENU** button to display the menu bar



D0105-EN

- 2 Press the **◀/▶** buttons to choose the menu you want to use and then press the **OK** button



D1105-EN

- 3 Press the **▼/▲** buttons to choose the item to be set, press the **◀/▶** buttons to set the item, and then press the **OK** button

If there are sub-menus, use the **◀/▶/▼/▲** buttons to operate them.

- Press the **BACK** button to return to the previous menu.
- Press the **TV** or **MENU** button to exit from the menu.
- Some menu items may not be operated or set depending on the TV status or other menu item settings. Menu items that cannot be operated or set are displayed in grey in the menu and cannot be chosen.

- The menu will disappear after about one minute if no operation is performed.

Operation with the buttons on the TV

You can also operate the menus using the buttons on the front panel of the TV.

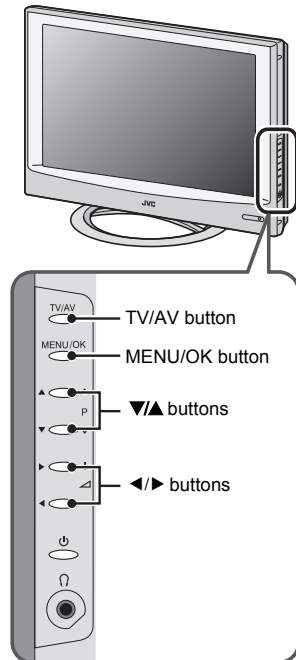

PICTURE menu

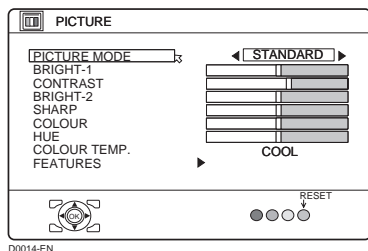

- While the PICTURE menu is displayed, pressing the blue button will set the BRIGHT-1, CONTRAST, BRIGHT-2, SHARP, COLOUR, HUE settings to their default settings.
- When watching the picture from EXT-1 to EXT-4 or the PC, picture effect settings can be memorised for each external input by setting the picture effects in the PICTURE menu.

The following items in the PICTURE menu are memorised.

PICTURE MODE
BRIGHT-1
CONTRAST
BRIGHT-2
SHARP
COLOUR
HUE
COLOUR TEMP.
DIGITAL VNR
COLOUR SYSTEM

The last setting made for each item is memorised.

PICTURE MODE

You can choose one of three PICTURE MODEs to adjust the picture settings automatically.

BRIGHT:

Heightens contrast and sharpness.

STANDARD:

Standardizes picture adjustment.

SOFT:

Softens contrast and sharpness.

BRIGHT-1

You can adjust the back light.

- ◀ : darker
- ▶ : brighter

CONTRAST

You can adjust the picture contrast.

- ◀ : lower
- ▶ : higher

BRIGHT-2

You can adjust the picture brightness.

- ◀ : darker
- ▶ : brighter

SHARP

You can adjust the picture sharpness.

- ◀ : softer
- ▶ : sharper

COLOUR

You can adjust the picture colour.

- ◀ : lighter
- ▶ : deeper

HUE

You can adjust the picture tint.

- ◀ : reddish
- ▶ : greenish
- You can change the HUE setting (picture hue) when the colour system is NTSC 3.58, or NTSC 4.43.

COLOUR TEMP.

You can select one of three COLOUR TEMP. modes (three tones of white) to adjust the white balance of the picture. Since white is the colour which is used as a reference for all the other colours, changing the COLOUR TEMP. mode affects the appearance of all the other colours on the screen.

COOL:

A bluish white. Using this mode when watching bright pictures allows you to enjoy a more vivid and bright picture.

NORMAL:

The normal white colour.

WARM:

A reddish white. Using this mode when watching films allows you to enjoy colours that are characteristic of films.

FEATURES

Choose FEATURES and press the **OK** or **▶** button to display the sub-menu.

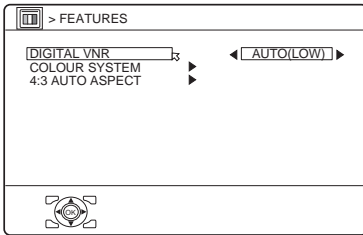

■ **DIGITAL VNR**

The DIGITAL VNR function cuts down the amount of ‘noise’ (‘snow’ or interference) in the original picture.

ON:

This function is turned on.

OFF:

This function is turned off.

■ **COLOUR SYSTEM**

The colour system is chosen automatically. However, if the picture is not clear or no colour appears, choose the colour system manually.

1 Choose COLOUR SYSTEM. Then press the OK or ▶ button

The sub-menu of the COLOUR SYSTEM function appears.

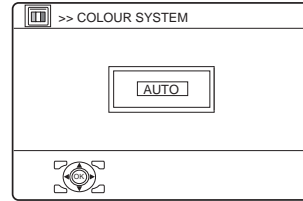

2 Press the ▼/▲ buttons to choose the appropriate colour system. Then press the OK button

PAL:

PAL system

SECAM:

SECAM system

NTSC 3.58:

NTSC 3.58 MHz system

NTSC 4.43:

NTSC 4.43 MHz system

AUTO:

This function detects a colour system from the input signal. You can only use this when you are viewing a picture from programme number PR 0 (AV), or an EXT terminal.

-
- The AUTO function may not function properly if you have poor signal quality. If the picture is abnormal in the AUTO function, choose another colour system manually.
 - When in the Programme numbers PR 0 (AV) to PR 99, you cannot choose NTSC 3.58 or NTSC 4.43.
 - COLOUR SYSTEM cannot be chosen when you are watching the PC picture.
-

■ 4:3 AUTO ASPECT

You can choose one of three ZOOM modes, REGULAR, PANORAMIC or 14:9 ZOOM, as the ZOOM mode for the normal picture (4:3 aspect ratio).

- 1 Choose 4:3 AUTO ASPECT then press the OK button

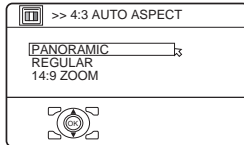

D0017-EN

- 2 Press the ▼/▲ buttons to choose a ZOOM mode

SOUND menu

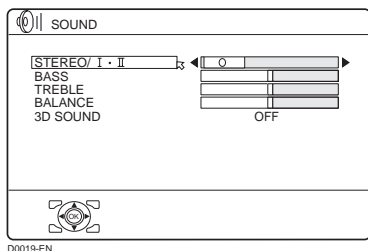

- When the headphones are connected, only “STEREO / I • II” can be used.

STEREO / I • II

When you are viewing a bilingual broadcast programme, you can choose the sound from Bilingual I (Sub I) or Bilingual II (Sub II). If you have poor reception on a stereo broadcast, you can change from stereo to mono sound so that you can hear the broadcast more clearly and easily.

⊕ : Stereo sound

○ : mono sound

I : Bilingual I (sub I)

II : Bilingual II (sub II)

-
- The sound mode you can choose differs depending on the TV programme.
 - This function does not work in the EXT modes.
-

BASS

You can adjust the low tone of the sound.

◀ : weaker

▶ : strong

TREBLE

You can adjust the high tone of the sound.

◀ : weaker

▶ : strong

BALANCE

You can adjust the volume balance between the left and right speaker.

◀ : turn the left speaker's volume level up.

▶ : turn the right speaker's volume level up.

3D SOUND

You can enjoy Surround sound with a “live” effect by using the 3D SOUND function.

- You can choose a 3D SOUND mode from ON, MONO and OFF modes. For details, see “3D SOUND function” on page 18.
- You can also operate the 3D SOUND function with the  button. For details, see “3D SOUND function” on page 18.

FEATURES menu

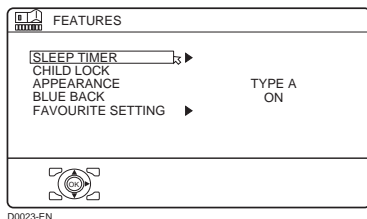

D0023-EN

SLEEP TIMER

You can set the TV to automatically turn off after a set period of time.

1 Choose SLEEP TIMER. Then press the OK or ► button

A Sub-menu of the SLEEP TIMER function appears.

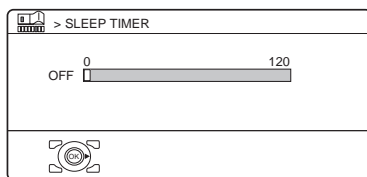

D0024-EN

2 Press the ◀/▶ buttons to set the period of time. Then press the OK button

You can set the period of time for up to 120 minutes (2 hours) in 10 minute steps.

- One minute before the SLEEP TIMER function turns off the TV, “GOODNIGHT!” appears.
- The SLEEP TIMER function cannot be used to turn off the TV’s main power.
- When the SLEEP TIMER function is on, you can display the sub-menu of the SLEEP TIMER function again to confirm or change the remaining period of time of the SLEEP TIMER function. Press the OK button to leave the menu after confirming or changing the remaining time.

To cancel the SLEEP TIMER function:

Press the ◀ button to set the period of time to “OFF”.

CHILD LOCK

When there is a TV channel you do not want your children to watch, you can use the CHILD LOCK function to lock out the TV channel. Even when a child chooses a programme number (PR) for a locked TV channel the screen will change to blue and display  (CHILD LOCK) so the TV channel cannot be viewed. Unless you enter a pre-set ID number by a special operation, the lock cannot be released and the child cannot view the TV channel.

■ To set the CHILD LOCK function

1 Choose CHILD LOCK, then press the 0 button

“SET ID NO.” (ID number setting screen) appears.

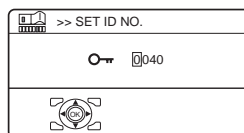

D0025-EN

2 Set the ID number to your liking

1 Press the ▼/▲ buttons to choose a number.

2 Press the ◀/▶ buttons to move the cursor.

3 Press the OK button

The Sub-menu of CHILD LOCK appears.

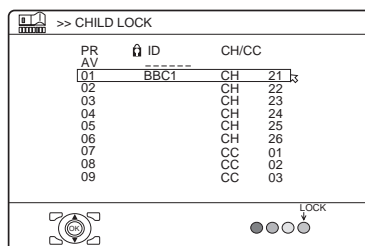

D0026-EN

4 Press the ▼/▲ buttons to choose a TV channel

Every time you press the ▼/▲ buttons, the Programme number (PR) changes, and the picture of the TV channel registered in the Programme number (PR) is displayed on the screen.

5 Press the blue button and set the CHILD LOCK function. Then press the OK button

Ⓔ (CHILD LOCK) appears and the TV channel is locked.

To reset the CHILD LOCK function:

Press the blue button again.

Ⓔ (CHILD LOCK) disappears.

To disable easy resetting of the CHILD LOCK function, the menu disappears if you choose the CHILD LOCK function and press the OK button.

■ To view a locked TV channel

1 Choose a programme number (PR) of a locked TV channel with the number buttons or PR LIST

The screen changes to blue and the Ⓔ (CHILD LOCK) appears. You cannot view the TV channel.



D0027-EN

2 Press the ⓘ (Information) button to display “ID NO.” (ID No. input screen)

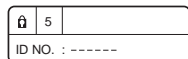

D0028-EN

3 Press the number buttons to enter the ID number

The lock is temporarily released so you can view the TV channel.

If you have forgotten the ID number:

Perform step 1 of “To set the CHILD LOCK function”. After confirming the ID number, press the TV button to exit the menu.

- Even if you reset the lock temporarily, it does not mean that the CHILD LOCK function set for the TV channel is cancelled. The next time anyone tries to view the TV channel, it will be locked again.
- When you want to cancel the CHILD LOCK function, you must perform the operation “To set the CHILD LOCK function” again.
- To stop it being easy to choose the programme number (PR) of a locked TV channel, the programme number (PR) has been set so that it cannot be chosen with the ▼/▲ buttons or the buttons of the TV.
- To stop it being easy to reset the lock, “ID NO.” (ID No. input screen) is set so that it cannot appear unless you press the ⓘ (Information) button.

APPEARANCE

Press the ◀/▶ button and choose the format in which the channel number is displayed from two types: TYPE A and TYPE B.

BLUE BACK

You can set the TV to automatically change to a blue screen and mute the sound if the signal is weak or absent, or when there is no input from an external device.

ON:

This function is turned on.

OFF:

This function is turned off.

FAVOURITE SETTING

Chose when deleting the favourite channels registered in the buttons 1 to 4.

1 Choose FAVOURITE SETTING, then press the OK or ► button

The FAVOURITE SETTING menu appears.

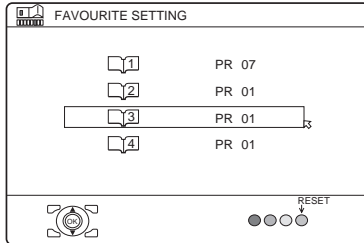

2 Press the ▼/▲ buttons and chose the favourite channel that you want to delete

3 Press the blue button

The chosen favourite channel and set contents are deleted.

- For details of the favourite channels, see “Favourite channel function” on page 19.

SET UP menu

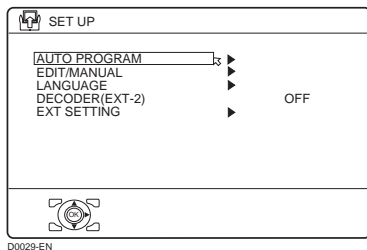

AUTO PROGRAM

You can again perform the AUTO PROGRAM function TV channel automatic registration which was performed in the “Initial settings” (page 7).

1 Choose AUTO PROGRAM, then press the OK or ► button

The COUNTRY menu appears as a sub-menu of the AUTO PROGRAM function. There are two COUNTRY menus. Pressing the yellow button changes the COUNTRY menu as follows:

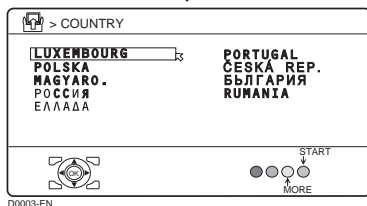
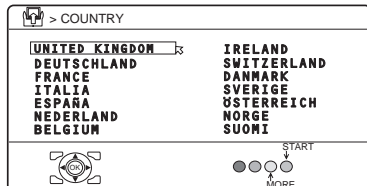

2 Press the ◀/▶ and ▼/▲ buttons to choose the country where you are

3 Perform steps 5 and 6 of the “Initial settings” (page 8)

EDIT/MANUAL

The EDIT/MANUAL functions are divided into two types:

- editing the current programme numbers (PR) (EDIT functions); and
- manually storing a TV channel you want to view on a particular programme number (PR) (MANUAL function).

Here are the details about these functions:

MOVE:

This function changes the programme number (PR) of a TV channel.

ID:

This function registers a channel name (ID) to a TV channel.

INSERT:

This function adds a new TV channel in the current programme numbers (PR) list by using the CH/CC number.

- You cannot use the INSERT function if you do not know the channel number of a TV channel. Use the MANUAL function to register a TV channel in the programme number (PR).

DELETE:

This function deletes a TV channel you do not want to list.

MANUAL:

This function manually stores a new TV channel in a programme number (PR).

Caution

- Using the MOVE, DELETE or INSERT functions rewrites the current programme numbers (PR) list. Therefore, the programme numbers (PR) of some of the TV channels will change.
- Using the MANUAL function for a TV channel for which the CHILD LOCK function has been set cancels the CHILD LOCK function for that channel.

- Using the MANUAL function for a TV channel for which the DECODER (EXT-2) function has been set to ON returns the setting of the DECODER (EXT-2) function for that channel to OFF.
- When a TV channel has already been registered in PR 99, using the INSERT function deletes that TV channel.

■ Basic operation

1 Choose EDIT/MANUAL, then press the OK or ► button

The EDIT menu appears.

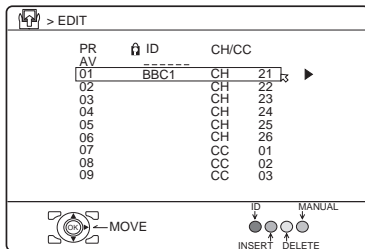

D0038-EN

2 Follow the description for the function you want to use

3 Press the OK button to complete the settings

The T-V LINK menu appears.

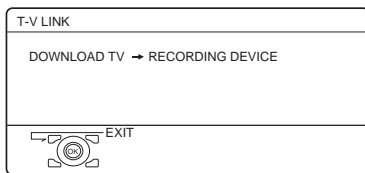

D0005-EN

If you do not have a T-V LINK compatible VCR connected:

Press the TV button to exit the T-V LINK menu.

The T-V LINK menu disappears.

If you have a T-V LINK compatible VCR connected to the EXT-2 terminal:

Follow “Downloading the data to VCR” on page 10 to transmit the programme number (PR) data.

- For programme number PR 0, “AV” appears in the programme numbers (PR) list.
- An EXT terminal number does not appear in the programme numbers (PR) list.

■ MOVE

1 Press the ▼/▲ buttons to choose a TV channel

2 Press the ► button to start the MOVE function

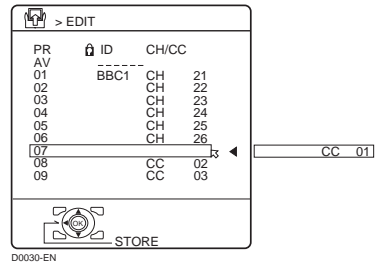

D0030-EN

3 Press the ▼/▲ buttons to choose a new programme number (PR)

To cancel the MOVE function:
Press the BACK button.

4 Press the ◀ button to change the programme number (PR) of a TV channel to a new programme number (PR)

■ DELETE

1 Press the ▼/▲ buttons to choose a TV channel

2 Press the yellow button to delete the TV channel

The TV channel is deleted from the programme numbers (PR) list.

■ ID

1 Press the ▼/▲ buttons to choose a TV channel

2 Press the red button to start the ID function

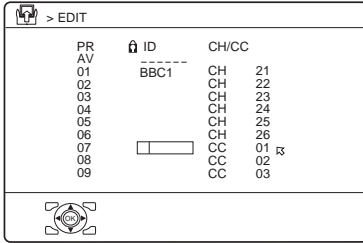

D0031-EN

3 Press the ▼/▲ buttons to choose a character

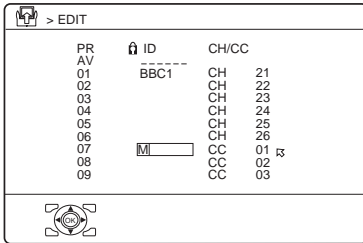

D0032-EN

4 Press the ◀/▶ buttons to move the cursor

5 Repeat steps 3 and 4 to complete the channel name

6 Press the OK button to give a channel name (ID) to a TV channel

Before performing INSERT or MANUAL operation

- If you register the TV channel (SECAM-L system) from a French station, be sure to set the COUNTRY setting to FRANCE. If the COUNTRY setting is not set to FRANCE, perform steps 1 and 2 of the “AUTO PROGRAM” (page 32) procedure and set the COUNTRY setting to FRANCE before pressing the OK button.
- A CH/CC number unique to this TV and corresponding to the Channel number of a TV channel is required. Find the corresponding CH/CC number from a table “CH/CC numbers” on page 44 based on the Channel number of the TV channel.
- When the COUNTRY setting is not FRANCE, use a two-digit CH/CC number. When the COUNTRY setting is FRANCE, use a three-digit CH/CC number.

■ INSERT

- 1 Press the **▼/▲** buttons to choose a programme number (PR) for which you will register a new TV channel
- 2 Press the green button and start the INSERT function

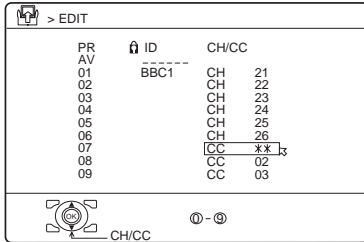

D0034-EN

To cancel the INSERT function:
Press the **BACK** button.

- 3 Press the **▼/▲** buttons to choose “CH” or “CC”, then enter the remaining CH or CC number
When the COUNTRY setting is FRANCE:
Choose “CH1”, “CH2”, “CC1” or “CC2”.

The TV shifts to registration mode.
When the registration is completed, the picture of the TV channel appears on the screen.

- The CH/CC number is a number given to each broadcast frequency that carries a TV channel. If the TV cannot detect the TV channel corresponding to the broadcast frequency indicated by the CH/CC number, a “no-signal” picture appears.

■ MANUAL

- 1 Press the **▼/▲** buttons to choose a programme number (PR) for a new TV channel
- 2 Press the blue button to activate the MANUAL function

At the right side following the CH/CC number, the SYSTEM (broadcasting system) of the TV channel appears.

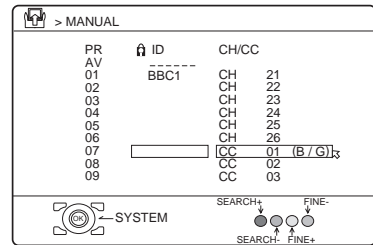

D0035-EN

To cancel the MANUAL function:
Press the **BACK** button.

- 3 Press the **▶** button to choose the **SYSTEM (broadcasting system)** for a TV channel you want to register
TV channel (SECAM-L system) from a French station:

Set the SYSTEM to “L”. If it is set to one other than “L”, you cannot receive the TV channel of the SECAM-L system.

Other TV channels:

If you do not know the correct broadcasting system, set the SYSTEM to “B/G”. If “B/G” is not correct, you will not hear the sound normally when the TV detects a TV channel. In this case, retry to set the SYSTEM correctly so that no problem arises.

4 Press the green or red button to search for a TV channel

Scanning stops when the TV finds a TV channel. Then the TV channel is displayed.

5 Press the green or red button repeatedly until the TV channel you want appears

If the TV channel reception is poor:
Press the blue or yellow button to fine-tune the TV channel.

6 Press the OK button and register the TV channel to a Programme number (PR)

The normal EDIT menu is resumed.

LANGUAGE

The LANGUAGE setting which was performed in the “Initial settings” (page 7) can be changed.

1 Choose LANGUAGE, then press the OK or ► button

A sub-menu of the LANGUAGE function appears.

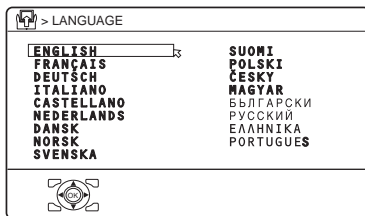

D0002-EN

2 Press the ◀/▶ and ▼/▲ buttons to choose a language. Then press the OK button

DECODER (EXT-2)

If you have a decoder connected to a T-V LINK compatible VCR, which in turn is connected to the EXT-2 terminal, use the DECODER (EXT-2) function to unscramble the scrambled TV channels.

1 Turn on the decoder power

2 Display the scrambled TV channel on the TV

Even if the decoder is working, a scrambled picture appears.

3 Display the SET UP menu and choose DECODER (EXT-2)

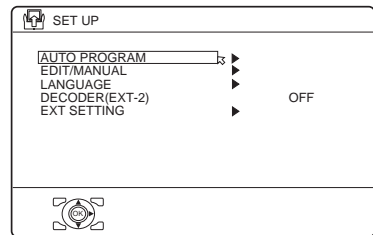

D0029-EN

4 Press the ◀/▶ buttons to choose ON

An unscrambled picture appears.

To cancel the DECODER (EXT-2) function:

Press the ◀/▶ buttons to choose OFF.

5 Press the OK button to complete the setting

The T-V LINK menu appears.

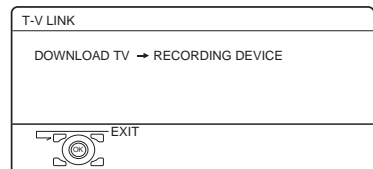

D0005-EN

You can send the programme numbers data to a VCR with the T-V LINK function.

6 Turn on the VCR, and then press the OK button to transmit the data to VCR

The T-V LINK menu disappears once the data transmission ends.

If the DECODER (EXT-2) function has been set to "ON" but the TV channel cannot be unscrambled, check the following:

- Has the decoder been connected to the VCR properly according to the VCR and decoder instruction manuals?
- Has the decoder power been turned on?
- Can the TV channel be unscrambled with a decoder?
- Do you need to change the VCR settings in order to connect the decoder? Confirm that the VCR is set properly by rechecking the VCR instruction manual.

EXT SETTING

1 Choose EXT SETTING, then press the OK or ► button

The EXT SETTING menu appears.

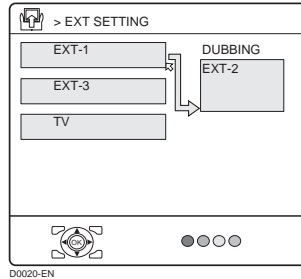

2 Follow the instructions for the function you want to use and operate the function

S-IN:

You can enjoy the high-quality picture of the S-VIDEO signal (Y/C signal).

DUBBING:

You can choose a signal source to be output from an EXT-2 terminal.

■ S-IN (S-VIDEO input)

You can connect a device (such as an S-VHS VCR) to enjoy the high-quality picture of the S-VIDEO signal (Y/C signal).

Preparation:

- First read the device's instruction manual and "Additional preparation" on page 40 to connect the device to the TV properly. Second, follow the device's instruction manual to set the device so that it sends an S-VIDEO signal (Y/C signal) to the TV.
- Do not set S-IN (S-VIDEO input) to an EXT terminal connected to a device which cannot output an S-VIDEO (Y/C signal).

1 Press the ◀/▶ or ▼/▲ buttons to choose an EXT terminal

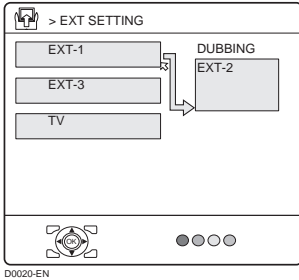

- Setting S-IN (S-VIDEO input) changes the head character from “E” to “S”. When an EXT terminal receives a normal video signal, “E2” appears on the display. This changes to “S2” when it receives an S-VIDEO signal.
- Even a device which can output an S-VIDEO signal (Y/C signal) may output a regular video signal (composite signal) depending on the device setting. If a picture cannot appear because the S-IN (S-VIDEO input) setting has been made, read the device instruction manual carefully again to check for the device settings.

■ DUBBING

You can choose a signal source to be output from the EXT-2 terminal.

You can do this with the output signals of the devices connected to other EXT terminals, or with the picture and sound from a TV channel you are currently viewing.

1 Press the ◀/▶ buttons to choose the arrow from the menu

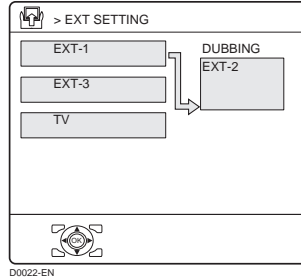

2 Press the ▼/▲ buttons to choose an EXT terminal or TV. Then press the OK button

The arrow in the menu represents a signal flow. The left side of the arrow shows a signal source output from the EXT-2 terminal.

EXT-1/EXT-3:

The output signal of the device connected to an EXT terminal passes through the TV and is output from the EXT-2 terminal.

TV:

The picture and sound of the TV channel you are currently viewing are output from the EXT-2 terminal.

-
- During dubbing, you cannot turn off the TV. Turning off the TV also turns off the output from the EXT-2 terminal.
 - When you choose an EXT terminal as an output, you can view a TV programme or a picture from the other EXT terminal while dubbing the picture from a device connected to the EXT terminal onto a VCR connected to the EXT-2 terminal.
 - The RGB signals from TV games cannot be output. Teletext programmes cannot be output.
-

Additional preparation

Connecting external equipment

Connect the equipment to the TV, making the correct rear panel and front panel connections.

Before connecting anything:

- Read the manuals that came with the equipment.
Depending on the equipment, the connection method may be different from the diagram. Also, the equipment settings may need to change depending on the connection method.
- Turn off all the equipment including the TV.
- The “Specifications” on page 50 give the details of the EXT terminals. If you are connecting equipment not listed in the following connection diagram, see the table to choose the best EXT terminal.
- Connecting cables are not supplied.

- ① VCR (composite signal)
- ② VCR (composite signal/S-VIDEO signal)
- ③ T-V LINK compatible VCR
(composite signal/S-VIDEO signal)
- ④ Decoder
- ⑤ DVD player
(composite signal/S-VIDEO signal)
- ⑥ DVD player
(composite signal/RGB signal)
- ⑦ DVD player
(component video signals; Y/Pb/Pr)
- ⑧ DVD player (digital video signals)
- ⑨ TV game (composite signal/RGB signal)
- ⑩ TV game (composite signal)
- ⑪ Headphones
- ⑫ Camcorder (composite signal)
- ⑬ Computer (analogue RGB signal)
- ⑭ SCART cable
- ⑮ Audio cable
- ⑯ Video cable
- ⑰ Component cable
- ⑱ DVI-HDMI converter cable
- ⑲ DVI cable
- ⑳ “DVI-I”-“D-SUB” converter cable

without terminal covers

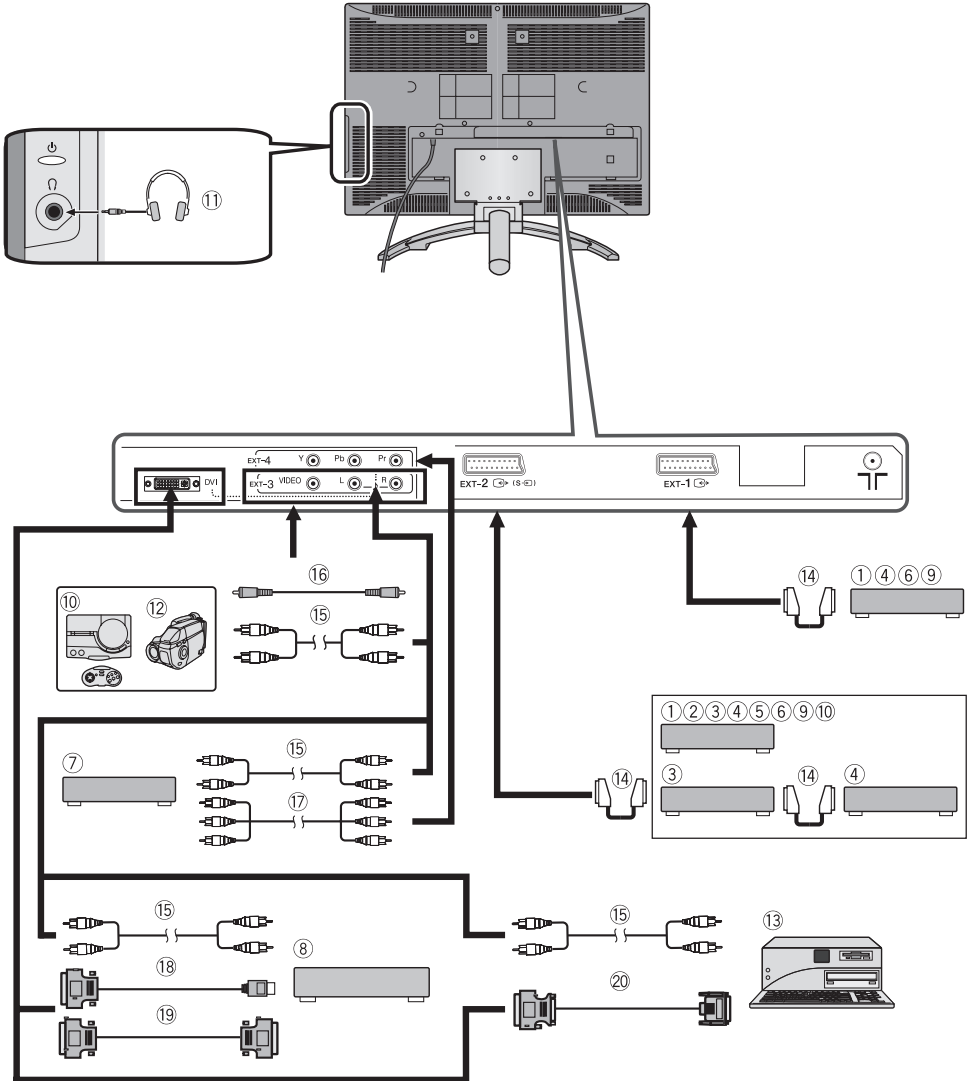

■ **Equipment which can output the S-VIDEO signal (Y/C signal) such as an S-VHS VCR**

Connect the equipment to an EXT-2 terminal. You can choose between an S-VIDEO signal (Y/C signal) and a regular video signal (composite signal). For details of how to operate the equipment, see “S-IN (S-VIDEO input)” on page 37.

■ **T-V LINK compatible VCR**

Be sure to connect the T-V LINK compatible VCR to the EXT-2 terminal. If not, the T-V LINK function will not work properly.

- When connecting a T-V LINK compatible VCR to the EXT-2 terminal, be sure to connect the decoder to the VCR. If not, the T-V LINK function may not work properly.
- When you connect the decoder to the VCR, after you have stored TV channels in the programme numbers (PR) list, set the DECODER (EXT-2) function for the programme number (PR) to ON to unscramble a scrambled TV channel. For details, see “DECODER (EXT-2)” on page 36.

■ **Connecting headphones**

Connect the headphones with a stereo mini-jack (3.5 mm diameter) to the headphone socket at the TV rear panel.

- No sound comes from the TV speakers when the headphones are connected.

■ **Video or sound signal output from the EXT-2 terminal**

You can change over the output of the video/sound signal from the EXT-2 terminal. This is useful when you want to dub the video/sound from another device onto the VCR connected to the EXT-2 terminal. For details on how to do this, see “DUBBING” on page 38.

- The signals from EXT-4 and PC IN terminal cannot be output from EXT-2.

■ **TV output from the EXT-1 terminal**

The video/sound signal of a TV channel you are viewing is always output from the EXT-1 terminal.

- Changing over a programme number (PR) also changes over the TV output from the EXT-1 terminal.
- The video/sound signal from an EXT terminal cannot be output.
- Teletext programmes cannot be output.

■ **Connecting to the computer**

Connect the D-SUB cable with “DVI-I”-“D-SUB” convert adapter from the computer’s analogue RGB output terminal to the DVI terminal on the back of the TV.

If you want to listen to the sound from the computer, use an audio cable to connect the VIDEO-3 AUDIO L/R sound input terminal to the computer’s sound output terminal.

When the sound from the computer is mono, connect to the VIDEO-3 AUDIO L terminal. To watch images from a computer, start the computer and press the **AV** or **P** \vee/\wedge buttons to choose “PC”.

-
- Refer to the computer’s manual for a detailed explanation of the connections at the computer side.
 - Ensure that the connectors are facing the correct way when connecting.
 - After connecting the D-SUB cable with “DVI-I”-“D-SUB” convert adapter, tighten the two screws to fix the connector in place.
 - Digital output with a DVI cable is not supported.
-

This TV is compatible with the following PC signals.

Resolution	Vertical frequency (Hz)	Horizontal frequency (kHz)
640 × 480 (VGA)	60.0	31.5
1024 × 768 (XGA)	60.0	42.0

- Only the above formats are supported.
- Even with the above formats and at 60 Hz, some problems may be experienced depending on the quality of the synchronous signal. (Depending on the quality, some pictures may not be displayed properly.)
- Apple Macintosh* computers are not supported.

When a picture is not displayed

Check the computer's refresh rate and set it to 60 Hz. Refer to the computer's instruction manual. Computers which cannot have their refresh rate set 60 Hz cannot be used with this unit.

- * Apple Macintosh is a registered trademark of Apple Computer, Inc.

■ Connecting to the HDMI or DVI compatible device

Connect the HDMI-DVI converter cable from the HDMI terminal on the back of your HDMI compatible device to the DVI terminal on the back of the TV and audio cable from the audio output from HDMI compatible device to the VIDEO-3 AUDIO L/R terminal on the back of the TV. To watch the images from a HDMI/DVI compatible device, press the **AV** or **P** \vee/\wedge buttons to choose "DVI".

- To connect the DVI compatible device to the DVI terminal, connect the DVI terminal of the DVI compatible device to the DVI terminal of the TV with the DVI cable.
- Ensure that the connectors are facing the correct way when connecting.
- After connecting the DVI-HDMI converter cable or DVI cable, tighten the two screws to fix the connector in place.
- Digital audio output from HDMI terminal is not supported.

The DVI of the TV is compatible with the following video signals.

VGA/60Hz	4:3
480i/60Hz (525i/60Hz)	4:3
480i/60Hz (525i/60Hz)	16:9
480p/60Hz (525p/60Hz)	16:9
576i/50Hz (625i/50Hz)	4:3
576i/50Hz (625i/50Hz)	16:9
576p/50Hz (625p/50Hz)	4:3
576p/50Hz (625p/50Hz)	16:9
720p/50Hz (750p/50Hz)	16:9
720p/60Hz (750p/60Hz)	16:9
1080i/50Hz (1125i/50Hz)	16:9
1080i/60Hz (1125i/60Hz)	16:9

CH/CC numbers

When you want to use the INSERT function on page 35, find the CH/CC number corresponding to the Channel number of the TV channel from this table.

CH	Channel	CH	Channel	CC	Channel	CC	Channel
CH 02 / CH 202	E2, R1	CH 40 / CH 240	E40, R40	CC 01 / CC 201	S1	CC 31 / CC 231	S31
CH 03 / CH 203	E3, ITALY A	CH 41 / CH 241	E41, R41	CC 02 / CC 202	S2	CC 32 / CC 232	S32
CH 04 / CH 204	E4, ITALY B, R2	CH 42 / CH 242	E42, R42	CC 03 / CC 203	S3	CC 33 / CC 233	S33
CH 05 / CH 205	E5, ITALY D, R6	CH 43 / CH 243	E43, R43	CC 04 / CC 204	S4	CC 34 / CC 234	S34
CH 06 / CH 206	E6, ITALY E, R7	CH 44 / CH 244	E44, R44	CC 05 / CC 205	S5	CC 35 / CC 235	S35
CH 07 / CH 207	E7, ITALY F, R8	CH 45 / CH 245	E45, R45	CC 06 / CC 206	S6	CC 36 / CC 236	S36
CH 08 / CH 208	E8, R9	CH 46 / CH 246	E46, R46	CC 07 / CC 207	S7	CC 37 / CC 237	S37
CH 09 / CH 209	E9, ITALY G	CH 47 / CH 247	E47, R47	CC 08 / CC 208	S8	CC 38 / CC 238	S38
CH 10 / CH 210	E10, ITALY H, R10	CH 48 / CH 248	E48, R48	CC 09 / CC 209	S9	CC 39 / CC 239	S39
CH 11 / CH 211	E11, ITALY H+1, R11	CH 49 / CH 249	E49, R49	CC 10 / CC 210	S10	CC 40 / CC 240	S40
CH 12 / CH 212	E12, ITALY H+2, R12	CH 50 / CH 250	E50, R50	CC 11 / CC 211	S11	CC 41 / CC 241	S41
CH 21 / CH 221	E21, R21	CH 51 / CH 251	E51, R51	CC 12 / CC 212	S12	CC 75 / CC 275	X
CH 22 / CH 222	E22, R22	CH 52 / CH 252	E52, R52	CC 13 / CC 213	S13	CC 76 / CC 276	Y, R3
CH 23 / CH 223	E23, R23	CH 53 / CH 253	E53, R53	CC 14 / CC 214	S14	CC 77 / CC 277	Z, ITALY C, R4
CH 24 / CH 224	E24, R24	CH 54 / CH 254	E54, R54	CC 15 / CC 215	S15	CC 78 / CC 278	Z+1, R5
CH 25 / CH 225	E25, R25	CH 55 / CH 255	E55, R55	CC 16 / CC 216	S16	CC 79 / CC 279	Z+2
CH 26 / CH 226	E26, R26	CH 56 / CH 256	E56, R56	CC 17 / CC 217	S17		
CH 27 / CH 227	E27, R27	CH 57 / CH 257	E57, R57	CC 18 / CC 218	S18		
CH 28 / CH 228	E28, R28	CH 58 / CH 258	E58, R58	CC 19 / CC 219	S19		
CH 29 / CH 229	E29, R29	CH 59 / CH 259	E59, R59	CC 20 / CC 220	S20		
CH 30 / CH 230	E30, R30	CH 60 / CH 260	E60, R60	CC 21 / CC 221	S21		
CH 31 / CH 231	E31, R31	CH 61 / CH 261	E61, R61	CC 22 / CC 222	S22		
CH 32 / CH 232	E32, R32	CH 62 / CH 262	E62, R62	CC 23 / CC 223	S23		
CH 33 / CH 233	E33, R33	CH 63 / CH 263	E63, R63	CC 24 / CC 224	S24		
CH 34 / CH 234	E34, R34	CH 64 / CH 264	E64, R64	CC 25 / CC 225	S25		
CH 35 / CH 235	E35, R35	CH 65 / CH 265	E65, R65	CC 26 / CC 226	S26		
CH 36 / CH 236	E36, R36	CH 66 / CH 266	E66, R66	CC 27 / CC 227	S27		
CH 37 / CH 237	E37, R37	CH 67 / CH 267	E67, R67	CC 28 / CC 228	S28		
CH 38 / CH 238	E38, R38	CH 68 / CH 268	E68, R68	CC 29 / CC 229	S29		
CH 39 / CH 239	E39, R39	CH 69 / CH 269	E69, R69	CC 30 / CC 230	S30		

CH	Channel	CH	Channel	CC	Frequency (MHz)	CC	Frequency (MHz)
CH 102	F2	CH 141	F41	CC 110	116 - 124	CC 152	391 - 399
CH 103	F3	CH 142	F42	CC 111	124 - 132	CC 153	399 - 407
CH 104	F4	CH 143	F43	CC 112	132 - 140	CC 154	407 - 415
CH 105	F5	CH 144	F44	CC 113	140 - 148	CC 155	415 - 423
CH 106	F6	CH 145	F45	CC 114	148 - 156	CC 156	423 - 431
CH 107	F7	CH 146	F46	CC 115	156 - 164	CC 157	431 - 439
CH 108	F8	CH 147	F47	CC 116	164 - 172	CC 158	439 - 447
CH 109	F9	CH 148	F48	CC 123	220 - 228	CC 159	447 - 455
CH 110	F10	CH 149	F49	CC 124	228 - 236	CC 160	455 - 463
CH 121	F21	CH 150	F50	CC 125	236 - 244	CC 161	463 - 469
CH 122	F22	CH 151	F51	CC 126	244 - 252		
CH 123	F23	CH 152	F52	CC 127	252 - 260		
CH 124	F24	CH 153	F53	CC 128	260 - 268		
CH 125	F25	CH 154	F54	CC 129	268 - 276		
CH 126	F26	CH 155	F55	CC 130	276 - 284		
CH 127	F27	CH 156	F56	CC 131	284 - 292		
CH 128	F28	CH 157	F57	CC 132	292 - 300		
CH 129	F29	CH 158	F58	CC 133	300 - 306		
CH 130	F30	CH 159	F59	CC 141	306 - 311		
CH 131	F31	CH 160	F60	CC 142	311 - 319		
CH 132	F32	CH 161	F61	CC 143	319 - 327		
CH 133	F33	CH 162	F62	CC 144	327 - 335		
CH 134	F34	CH 163	F63	CC 145	335 - 343		
CH 135	F35	CH 164	F64	CC 146	343 - 351		
CH 136	F36	CH 165	F65	CC 147	351 - 359		
CH 137	F37	CH 166	F66	CC 148	359 - 367		
CH 138	F38	CH 167	F67	CC 149	367 - 375		
CH 139	F39	CH 168	F68	CC 150	375 - 383		
CH 140	F40	CH 169	F69	CC 151	383 - 391		

-
- When two CH/CC numbers correspond to one Channel number, choose either one according to the current COUNTRY setting. When the COUNTRY setting is other than FRANCE, choose a two-digit CH/CC number. When the COUNTRY setting is FRANCE, choose a three-digit CH/CC number.
 - Find the CH/CC number (CC110 to CC161) corresponding to the TV channel (SECAM-L system) from a French cable TV station, based on the broadcast frequency of the TV channel. When you do not know the broadcast frequency, please contact the cable TV station.
 - The CH/CC numbers of CH102-CH169 and CC110-CC161 correspond to the TV channels being broadcast by a SECAM-L system. The other CH/CC numbers correspond to the TV channels being broadcast by a method other than a SECAM-L system.
-

Troubleshooting

If a problem arises while you are using the TV, please read this troubleshooting guide carefully before you ask to have the TV repaired. You may be able to fix it easily by yourself. For example, if the mains plug is disconnected from the mains outlet, or the TV aerial has problems, you may think there is a problem with the TV itself.

Important:

- This troubleshooting guide only covers problems whose causes are not easy to decide. If you have a question when you are operating a function, read the page(s) for that function carefully, not this troubleshooting guide.
- If you follow the advice in this troubleshooting guide without any success, unplug the mains plug and ask for your TV to be repaired. Do not attempt to repair the TV by yourself or to remove the rear cover of the TV.

■ If you cannot turn on the TV

- Is the mains plug connected to the mains outlet?
- Is the power lamp lit? If not, press the \odot button on the TV.
- Make sure you set the VCR/TV/DVD switch to the TV position. You cannot turn the TV on when the VCR/TV/DVD switch is set to the VCR or DVD position.

■ If you cannot turn off the TV

- Make sure you set the VCR/TV/DVD switch to the TV position. You cannot turn the TV off when the VCR/TV/DVD switch is set to the VCR or DVD position.

■ No picture or no sound

- Have you chosen a TV channel with very poor reception? If so, the BLUE BACK function will be activated: the entire screen becomes blue, and the sound is muted. If you still want to view the TV channel, follow the description “BLUE BACK” on page 30 to change the BLUE BACK function setting to OFF.
- If the SYSTEM setting for a TV channel is incorrect, it may prevent the sound from being issued. Follow the description “EDIT/MANUAL” on page 32 to use the MANUAL function to try to change the SYSTEM setting.
- When you are using EXT-3, EXT-4 or DVI terminal, make sure the audio cable is connected to EXT-3 L/R terminal.

■ Poor picture

- If noise (snow) totally blocks out the picture, there may be a problem with the aerial or aerial cable. Check the following to try to solve the problem:
 - Have the TV and aerial been connected properly?
 - Has the aerial cable been damaged?
 - Is the aerial pointing in the right direction?
 - Is the aerial itself faulty?
- If the TV or aerial suffers interference from other equipment, stripes or noise may appear in the picture. Move any equipment such as an amplifier, personal computer, or a hair drier, that can cause interference away from your TV. Or try moving the TV. If the aerial suffers interference from a radio tower or high-voltage wire, please contact your local dealer.
- If the TV suffers interference from signals reflecting from mountains or buildings, double-pictures (ghosting) will occur. Try to change the aerial’s direction or replace it with one with better directionality.
- Are your COLOUR SYSTEM settings correct? Follow the description “COLOUR SYSTEM” on page 26 to try to solve the trouble.
- Have the COLOUR and BRIGHT settings been adjusted properly? Follow the description “BRIGHT-2” and “COLOUR” on page 25 to try to adjust them properly.

- Videotaping teletext is not recommended because it may not record correctly.
- When viewing images from commercially available video software products, or videos from videotapes which have been recorded improperly, the top of the image may be distorted. This is due to the condition of the video signal. There is nothing wrong with the TV.
- Since this TV is designed to make full use of the resolution of the original video source, the motion may appear unnatural when the video source is input with progressive-scanning component signals. If this occurs, change the output setting of the connected device to interlace-scanning component signal output. See the instructions that came with the device for more information.

■ **Poor sound**

- Have you adjusted BASS or TREBLE properly? If not, follow the description “BASS” or “TREBLE” on page 28.
- When TV channel reception is poor, it can be hard to hear stereo or bilingual sound. In this case, follow the description “STEREO / I • II” on page 28 to hear the sound more easily by changing it to a mono sound.

■ **If the TV does not respond to the remote control**

- Have the batteries of the remote control worn out? Follow the description “Putting the batteries into the remote control” on page 7 and replace them with new batteries.
- Have you attempted to use the remote control from the sides or rear of the TV or from more than seven metres away from the TV? Use the remote control in front of your TV or from less than seven metres away.
- When you are viewing a teletext programme, you cannot operate the menus. Press the **TV** button to return to the ordinary TV programme, and then try operating the menus.
- If the TV suddenly stops responding, disconnect the power cord of the TV from the AC outlet. Connect them to the AC outlet again to turn on the TV. If the TV returns to a normal state, it is not a failure.

■ **Other issues**

- When the SLEEP TIMER function operates, the TV is automatically turned off. If the TV suddenly turns off, try to press the **⏻/I** (standby) button to turn on the TV once again. If the TV goes back to normal, there is no problem.
- When the TV is receiving a wide-screen signal (WSS) or a signal from an external device affecting the screen size, the ZOOM mode automatically changes. When you want to resume the previous ZOOM mode, press the **ZOOM** button again.
- It takes a short period of time from the time an operation such as changing channels is performed until an image is displayed. This is not a fault. This is the time needed for the image to stabilize before it can be displayed.
- The TV may make a crackling sound due to a sudden change in temperature. The picture or sound may be normal. If you hear crackling sounds frequently while you are viewing the TV, there may be other causes. As a precaution, ask your service technician to inspect it.

- The top of the TV and the screen may become hot during use but this has no affect on the performance of the TV. Make sure that the ventilation holes are not blocked.
- When the picture is unstable, the screen may become white for a moment. This happens when the signal which drives the liquid crystal is missing. This is not a fault.
- When a still image has been displayed for a long period, a faint residual image may remain on the screen for a short time after the power has been turned off or when another image is displayed. This is not a fault and the image will eventually disappear.

Cable management

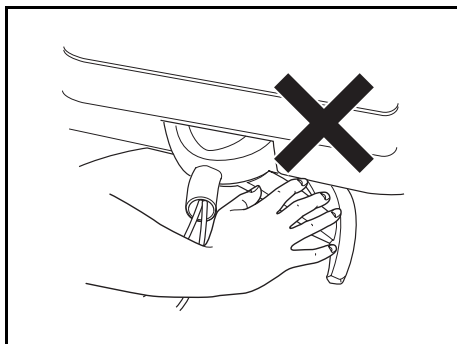
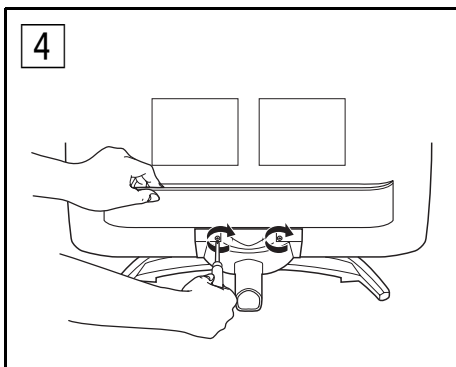
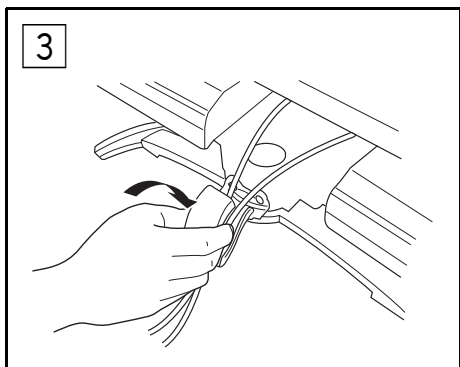
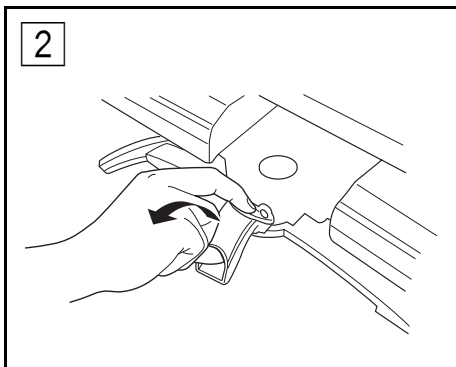
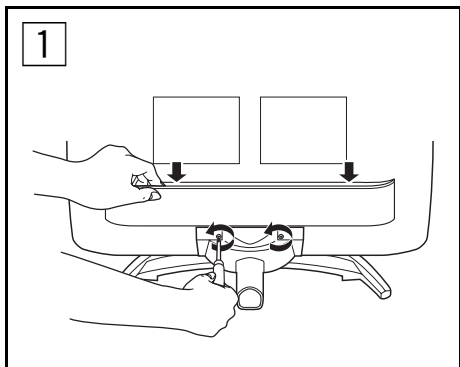

Specifications

Model	LT-32A61BU/LT-32A61SU	LT-26A61BU/LT-26A61SU
Broadcasting systems	CCIR B/G, I, D/K, L	
Colour systems	PAL, SECAM • The EXT terminals also support the NTSC 3.58/4.43 MHz system.	
Channels and frequencies	F2-F10, F21-F69, 116-172, E2-E12, E21-E69, S1-S41, X, Y, Z, Z+1, Z+2, A-H, H+1, H+2, R1-R12, R21-R69 • French cable TV channel of broadcast frequencies 116 - 172 MHz and 220 - 469 MHz.	
Sound-multiplex systems	NICAM (B/G, I, D/K, L) system, A2 (B/G, D/K) system	
Teletext systems	FLOF (Fastext), TOP, WST (World Standard System)	
Power requirements	110 - 240 V AC, 50/60 Hz	
Screen size	Viewable area 80 cm (measured diagonally)	Viewable area 66 cm (measured diagonally)
Audio output	Rated Power output: 5 W + 5 W	
Speakers	6.6 cm round × 2	
EXT-1 terminal	Euroconnector (21-pin, SCART) • Video input, Audio L/R inputs and RGB inputs are available. • TV broadcast outputs (Video and Audio L/R) are available.	
EXT-2 terminal	Euroconnector (21-pin, SCART) • Video input, S-VIDEO (Y/C) input, Audio L/R inputs and RGB inputs are available. • Video and Audio L/R outputs are available. • T-V LINK functions are available.	
EXT-3 terminal	RCA connectors × 3 • Video input and Audio L/R inputs are available.	
EXT-4 terminal	RCA connectors × 3 + EXT-3 L/R • Component video (Y, Pb, Pr) input and Audio L/R inputs are available. • 625p, 525p, 750p and 1080i signals are available. 750p signal is only available for 60Hz. • Some DVD players can output 625p, 525p, 750p and 1080i signals. • 750p are new high-definition signals.	
DVI terminal	DVI terminal × 1 • Digital video input and PC signal is available. (Refer to page 41 for details).	
Headphone jack	Stereo mini-jack (3.5 mm in diameter)	
Dimensions (W × H × D)	820 mm × 602 mm × 269 mm 820 mm × 551 mm × 126.8 mm (without stand)	686 mm × 525 mm × 269 mm 686 mm × 474 mm × 121.5 mm (without stand)
Weight	18.1 kg 15.5 kg (without stand)	14.9 kg 12.3 kg (without stand)
Accessories	Remote control unit × 1 (RM-C1816S) AA/R6 dry cell battery × 2	

We may change the design and specifications without notice.

Pictures displayed on the screen using this TV's ZOOM functions should not be shown for any commercial or demonstration purpose in public places (cafes, hotels, etc.) without the consent of the owners of copyright of the original picture sources, as this would be an infringement of copyright.

JVC



JVC

JVC

SCHEMATIC DIAGRAMS

WIDE LCD PANEL TELEVISION

**LT-26A61BJ, LT-26A61BU, LT-26A61BU_{IC},
LT-26A61SJ, LT-26A61SU, LT-26A61SU_{IC},
LT-32A61BJ, LT-32A61BU, LT-32A61BU_{IC},
LT-32A61SJ, LT-32A61SU, LT-32A61SU_{IC}**

CD-ROM No.SML200512

BASIC CHASSIS

FT

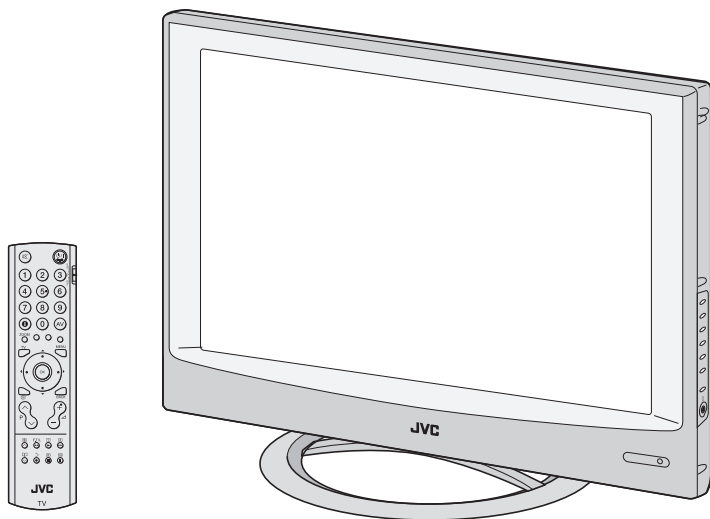

InterArt
T-V LINK
HD
ready

LT-26A61BJ, LT-26A61BU, LT-26A61BU/C, LT-26A61SJ, LT-26A61SU, LT-26A61SU/C, LT-32A61BJ, LT-32A61BU, LT-32A61BU/C, LT-32A61SJ, LT-32A61SU, LT-32A61SU/C

STANDARD CIRCUIT DIAGRAM

NOTE ON USING CIRCUIT DIAGRAMS

1.SAFETY

The components identified by the \triangle symbol and shading are critical for safety. For continued safety replace safety critical components only with manufactures recommended parts.

2.SPECIFIED VOLTAGE AND WAVEFORM VALUES

The voltage and waveform values have been measured under the following conditions.

- (1)Input signal : Colour bar signal
- (2)Setting positions of each knob/button and variable resistor : Original setting position when shipped
- (3)Internal resistance of tester : DC 20k Ω /V
- (4)Oscilloscope sweeping time : H \Rightarrow 20 μ s / div
: V \Rightarrow 5ms / div
: Others \Rightarrow Sweeping time is specified
- (5)Voltage values : All DC voltage values

* Since the voltage values of signal circuit vary to some extent according to adjustments, use them as reference values.

3.INDICATION OF PARTS SYMBOL [EXAMPLE]

- In the PW board : R209 \rightarrow R209

4.INDICATIONS ON THE CIRCUIT DIAGRAM

(1)Resistors

- Resistance value

No unit	: [Ω]
K	: [k Ω]
M	: [M Ω]

- Rated allowable power

No indication	: 1/16 [W]
Others	: As specified

- Type

No indication	: Carbon resistor
OMR	: Oxide metal film resistor
MFR	: Metal film resistor
MPR	: Metal plate resistor
UNFR	: Uninflammable resistor
FR	: Fusible resistor

* Composition resistor 1/2 [W] is specified as 1/2S or Comp.

(2)Capacitors

- Capacitance value

1 or higher	: [pF]
less than 1	: [μ F]

- Withstand voltage

No indication	: DC50[V]
Others	: DC withstand voltage [V]
AC indicated	: AC withstand voltage [V]

* Electrolytic Capacitors

47/50[Example]: Capacitance value [μ F]/withstand voltage[V]

- Type

No indication	: Ceramic capacitor
MM	: Metalized mylar capacitor
PP	: Polypropylene capacitor
MPP	: Metalized polypropylene capacitor
MF	: Metalized film capacitor
TF	: Thin film capacitor
BP	: Bipolar electrolytic capacitor
TAN	: Tantalum capacitor

(3)Coils

No unit	: [μ H]
Others	: As specified

(4)Power Supply



* Respective voltage values are indicated

(5)Test point



(6)Connecting method

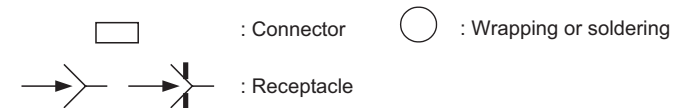

(7)Ground symbol

\perp	: LIVE side ground
\downarrow	: ISOLATED(NEUTRAL) side ground
\equiv	: EARTH ground
∇	: DIGITAL ground

5.NOTE FOR REPAIRING SERVICE

This model's power circuit is partly different in the GND. The difference of the GND is shown by the LIVE : (\perp) side GND and the ISOLATED(NEUTRAL) : (\downarrow) side GND. Therefore, care must be taken for the following points.

- (1)Do not touch the LIVE side GND or the LIVE side GND and the ISOLATED(NEUTRAL) side GND simultaneously. If the above caution is not respected, an electric shock may be caused. Therefore, make sure that the power cord is surely removed from the receptacle when, for example, the chassis is pulled out.
- (2)Do not short between the LIVE side GND and ISOLATED(NEUTRAL) side GND or never measure with a measuring apparatus measure with a measuring apparatus (oscilloscope, etc.) the LIVE side GND and ISOLATED(NEUTRAL) side GND at the same time. If the above precaution is not respected, a fuse or any parts will be broken.

◆ Since the circuit diagram is a standard one, the circuit and circuit constants may be subject to change for improvement without any notice.

NOTE

◆ Due improvement in performance, some part numbers show in the circuit diagram may not agree with those indicated in the part list.
When ordering parts, please use the numbers that appear in the Parts List.

CONTENTS

SEMICONDUCTOR SHAPES	2-2
WIRING DIAGRAM	2-3
BLOCK DIAGRAM	2-5
CIRCUIT DIAGRAMS	
MAIN PWB CIRCUIT DIAGRAM	2-7
KEY PWB CIRCUIT DIAGRAM	2-17
LED PWB CIRCUIT DIAGRAM	2-18
POWER PWB CIRCUIT DIAGRAM	2-19
PATTERN DIAGRAMS	
MAIN PWB PATTERN	2-25
POWER PWB PATTERN	2-29
KEY PWB PATTERN	2-31
LED PWB PATTERN	2-31
VOLTAGE CHATRS	2-32
WAVEFORMS	2-33

USING P.W. BOARD

P.W.B ASS'Y name	LT-26A61BJ	LT-26A61BU	LT-26A61BU/C	LT-26A61SJ	LT-26A61SU	LT-26A61SU/C
MAIN P.W. BOARD	QAL0823-001	←	←	QAL0822-001	←	QAL0823-001
POWER P.W. BOARD	QAL0826-001	←	←	←	←	←
LED P.W. BOARD	QAL0827-001	←	←	←	←	←
KEY P.W. BOARD	QAL0828-001	←	←	←	←	←

P.W.B ASS'Y name	LT-32A61BJ	LT-32A61BU	LT-32A61BU/C	LT-32A61SJ	LT-32A61SU	LT-32A61SU/C
MAIN P.W. BOARD	QAL0825-001	←	QAL0824-001	←	←	QAL0825-001
POWER P.W. BOARD	QAL0826-001	←	←	←	←	←
LED P.W. BOARD	QAL0827-001	←	←	←	←	←
KEY P.W. BOARD	QAL0828-001	←	←	←	←	←

SEMICONDUCTOR SHAPES

TRANSISTOR

BOTTOM VIEW	FRONT VIEW				TOP VIEW
					CHIP TR

IC

BOTTOM VIEW	FRONT VIEW			TOP VIEW

CHIP IC

TOP VIEW	

WIRING DIAGRAM

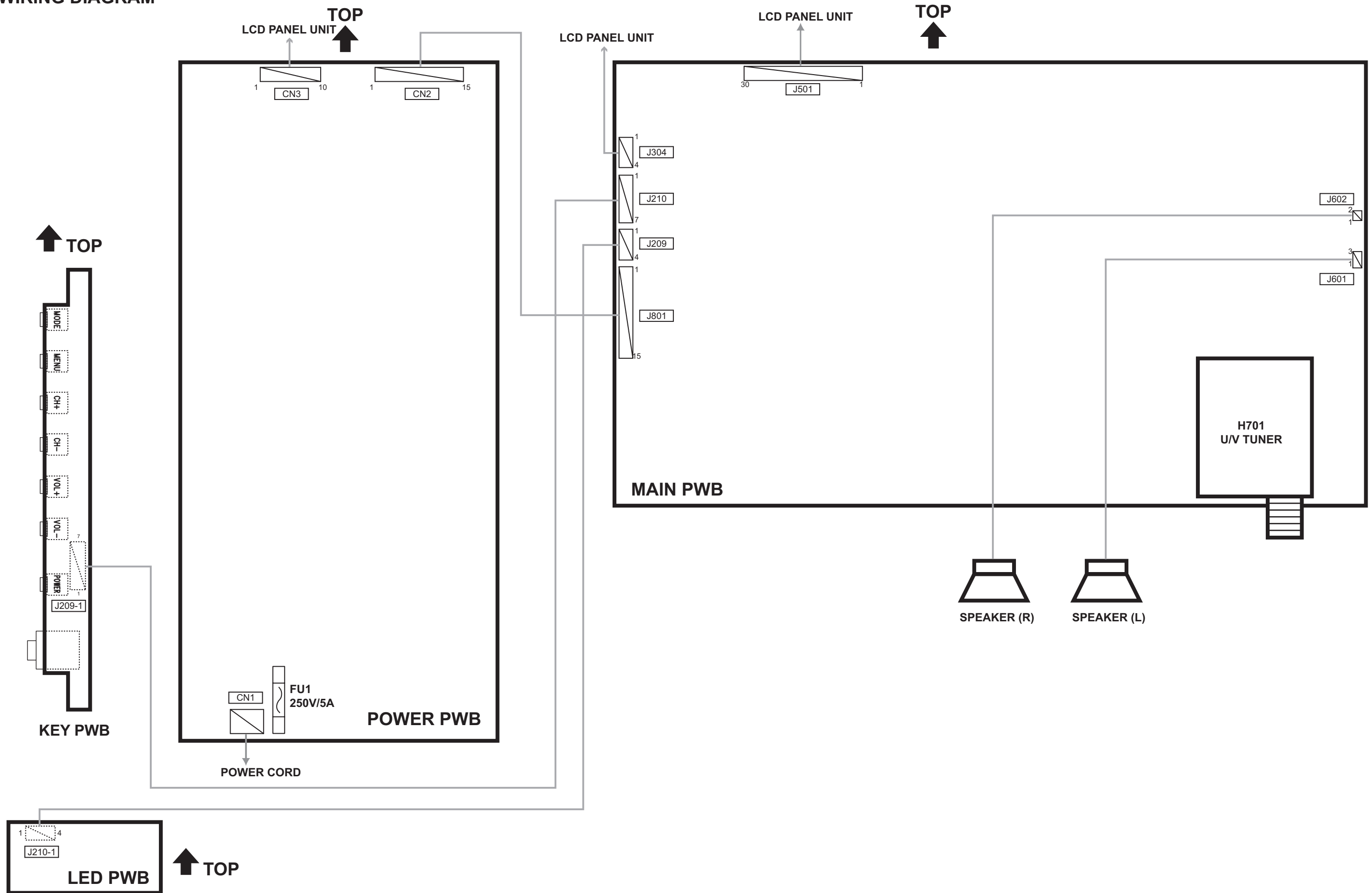

BLOCK DIAGRAM

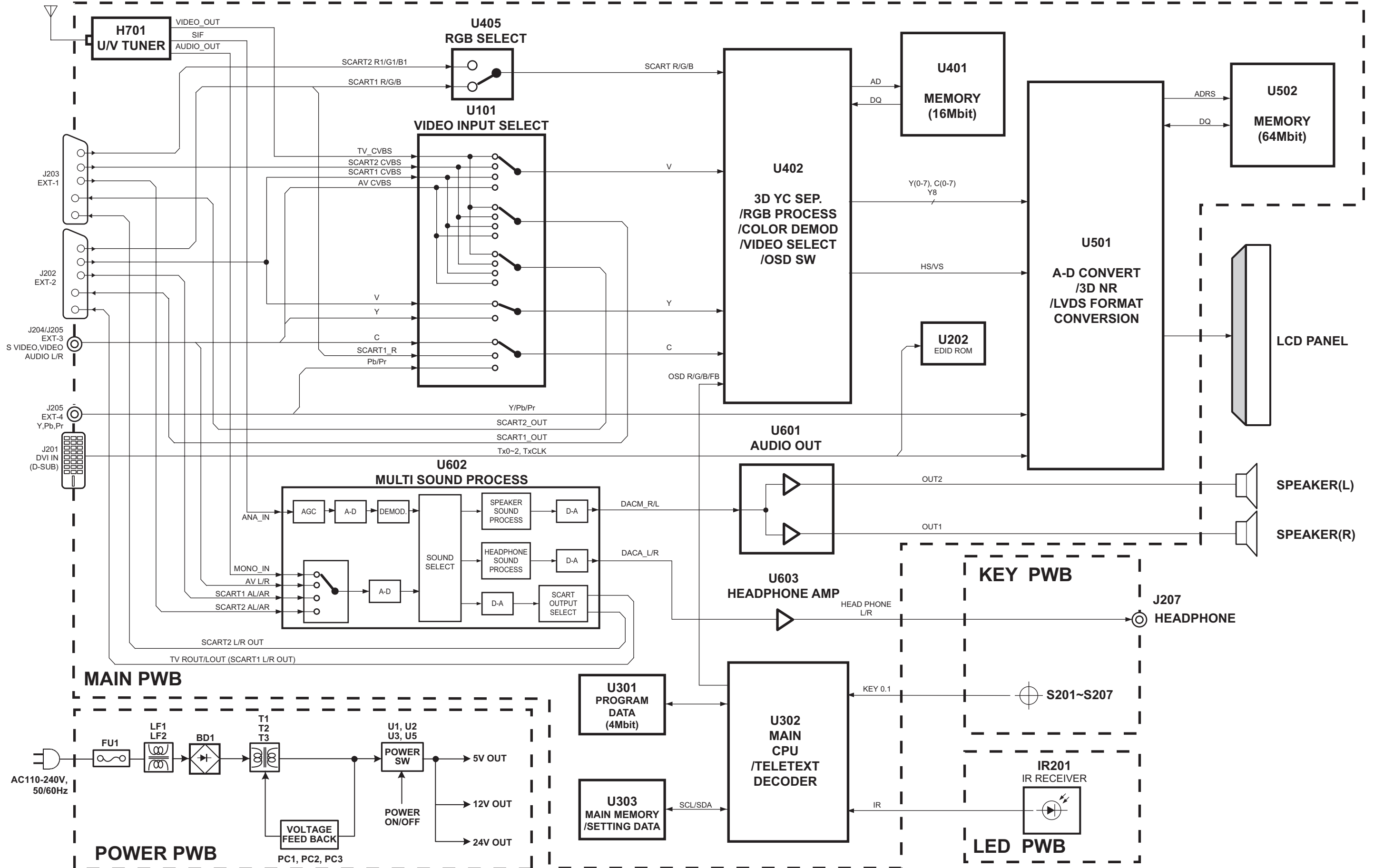

CIRCUIT DIAGRAMS
 MAIN PWB CIRCUIT DIAGRAM [WHOLE CHART]

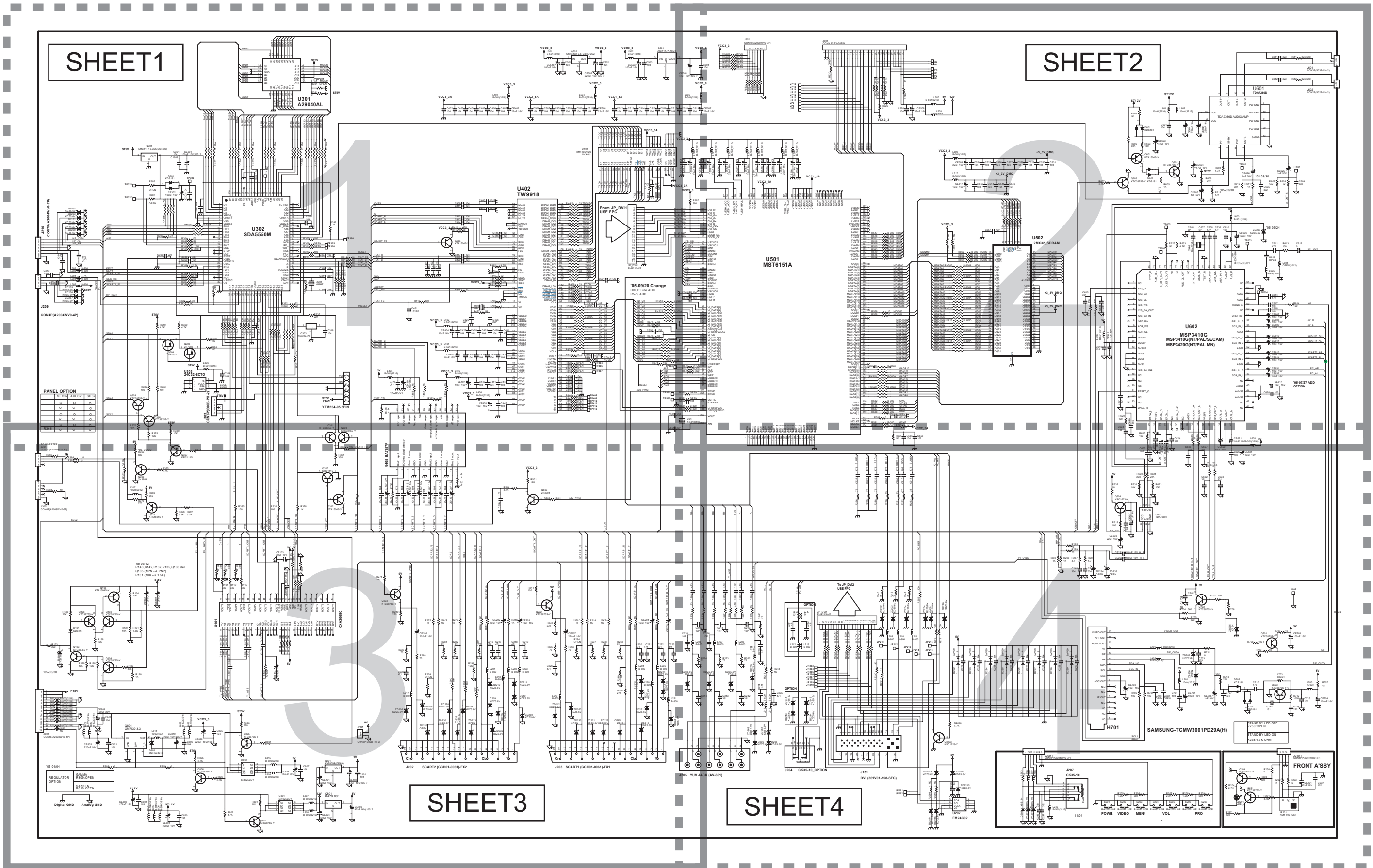

Note: Please refer to SHEET1-4 for details of this circuit diagram.

NOTE : Refer to the part list for the part number of U301 and U303.

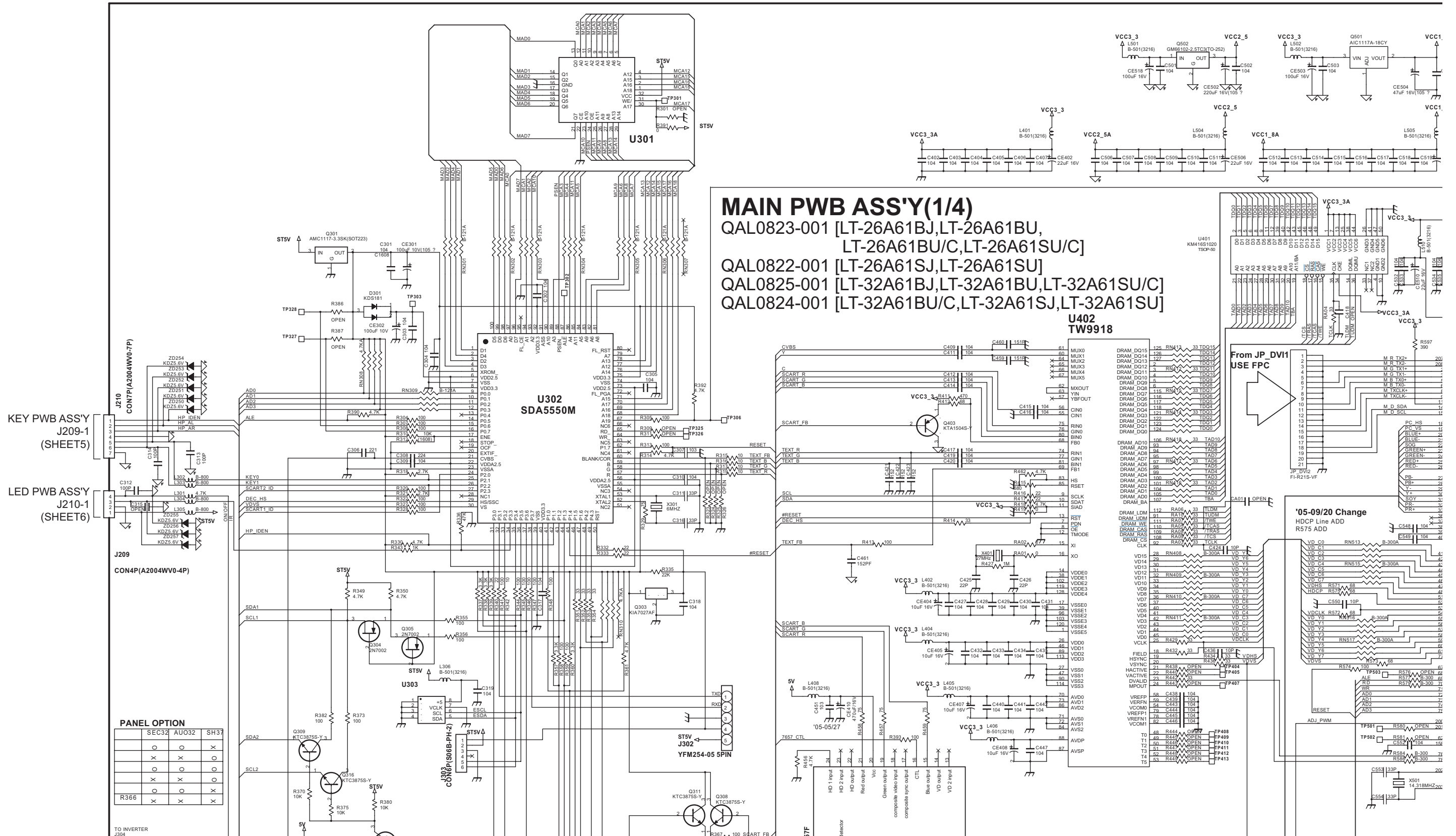

MAIN PWB ASS'Y(1/4)
 QAL0823-001 [LT-26A61BJ,LT-26A61BU,
 LT-26A61BU/C,LT-26A61SU/C]
 QAL0822-001 [LT-26A61SJ,LT-26A61SU]
 QAL0825-001 [LT-32A61BJ,LT-32A61BU,LT-32A61SU/C]
 QAL0824-001 [LT-32A61BU/C,LT-32A61SJ,LT-32A61SU]

**U402
TW9918**

**U302
SDA5550M**

PANEL OPTION

	SEC32	AUO32	SH37
	O	O	X
	X	X	O
	O	X	O
	X	O	X
	X	X	X
R366	X	X	X

MAIN PWB ASS'Y(2/4)

QAL0823-001 [LT-26A61BJ,LT-26A61BU,
LT-26A61BU/C,LT-26A61SU/C]

QAL0822-001 [LT-26A61SJ,LT-26A61SU]

QAL0825-001 [LT-32A61BJ,LT-32A61BU,LT-32A61SU/C]

QAL0824-001 [LT-32A61BU/C,LT-32A61SJ,LT-32A61SU]

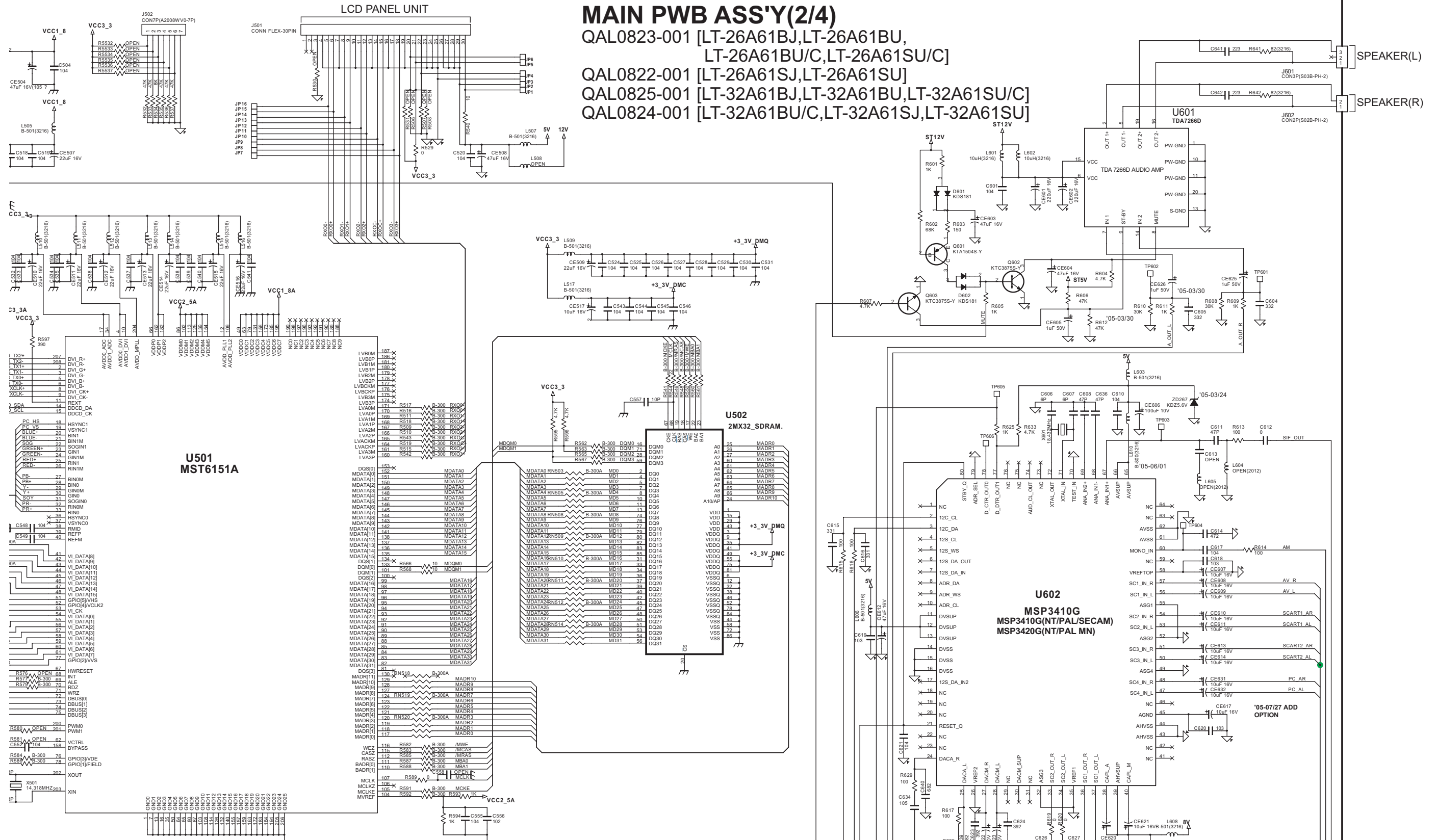

MAIN PWB CIRCUIT DIAGRAM (3/4) SHEET3

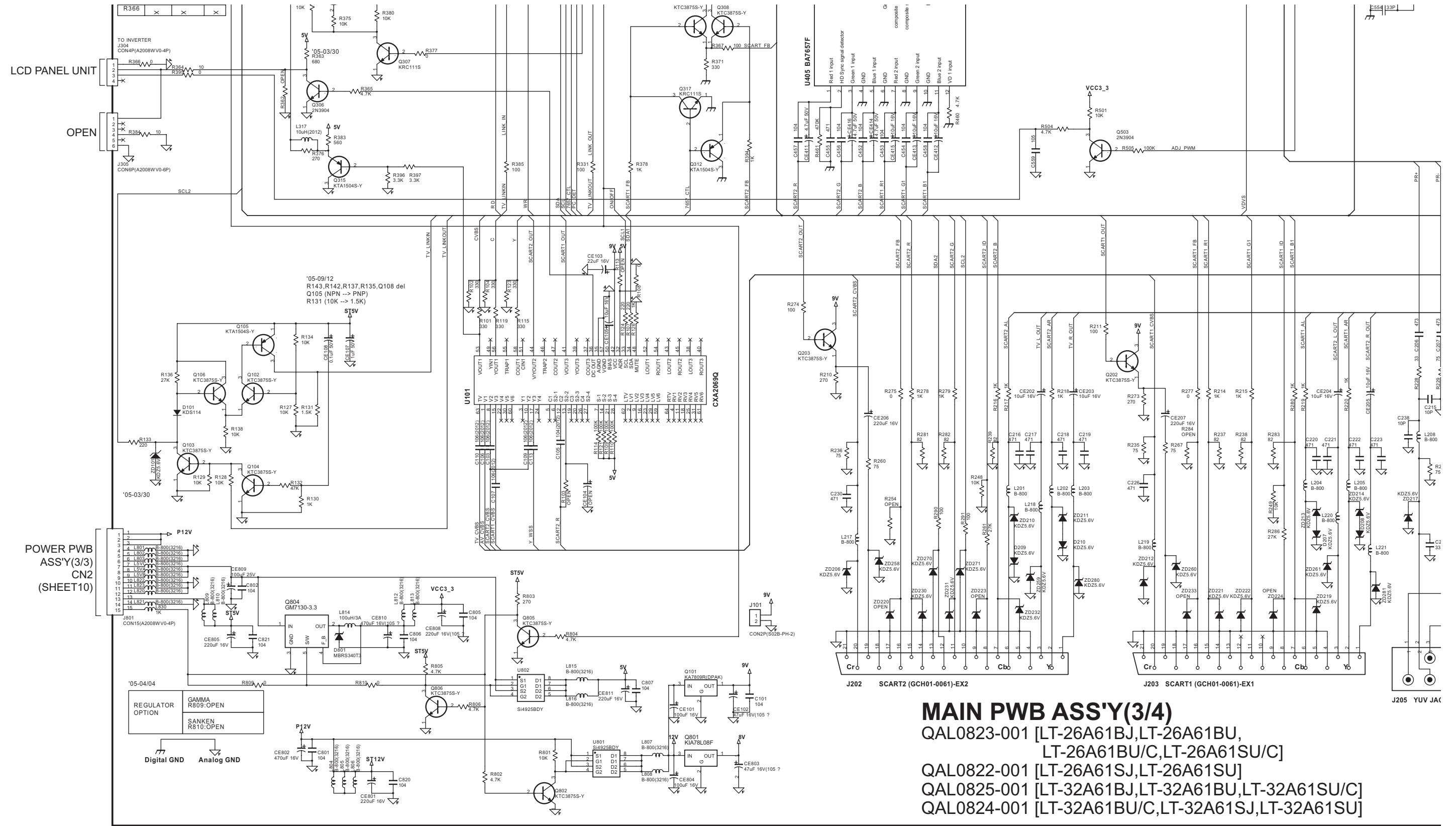

- MAIN PWB ASS'Y(3/4)**
 QAL0823-001 [LT-26A61BJ,LT-26A61BU, LT-26A61BU/C,LT-26A61SU/C]
 QAL0822-001 [LT-26A61SJ,LT-26A61SU]
 QAL0825-001 [LT-32A61BJ,LT-32A61BU,LT-32A61SU/C]
 QAL0824-001 [LT-32A61BU/C,LT-32A61SJ,LT-32A61SU]

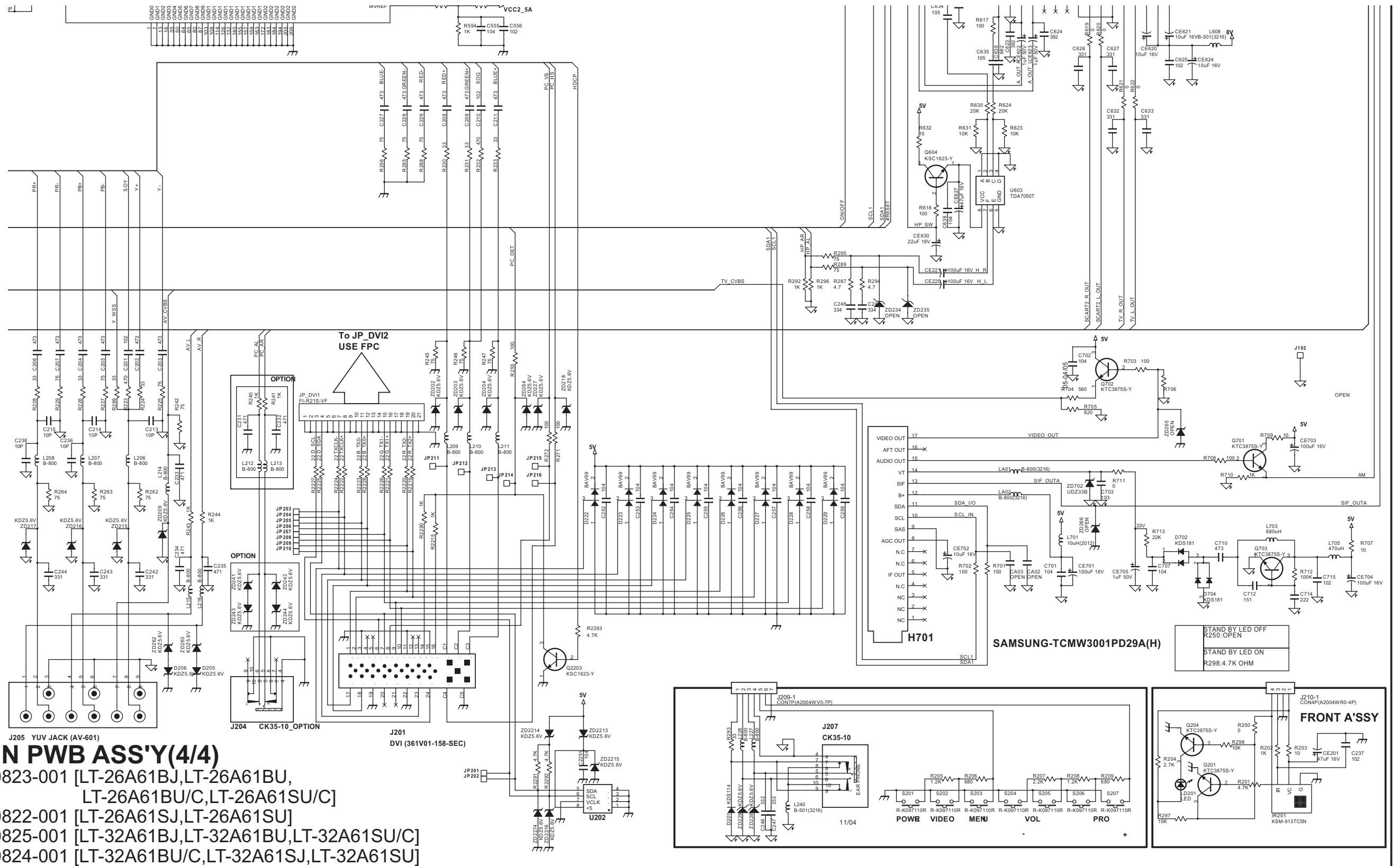

MAIN PWB ASS'Y(4/4)

QAL0823-001 [LT-26A61BJ,LT-26A61BU,
LT-26A61BU/C,LT-26A61SU/C]

QAL0822-001 [LT-26A61SJ,LT-26A61SU]

QAL0825-001 [LT-32A61BJ,LT-32A61BU,LT-32A61SU/C]

QAL0824-001 [LT-32A61BU/C,LT-32A61SJ,LT-32A61SU]

NOTE : Refer to the part list for the part number of U202.

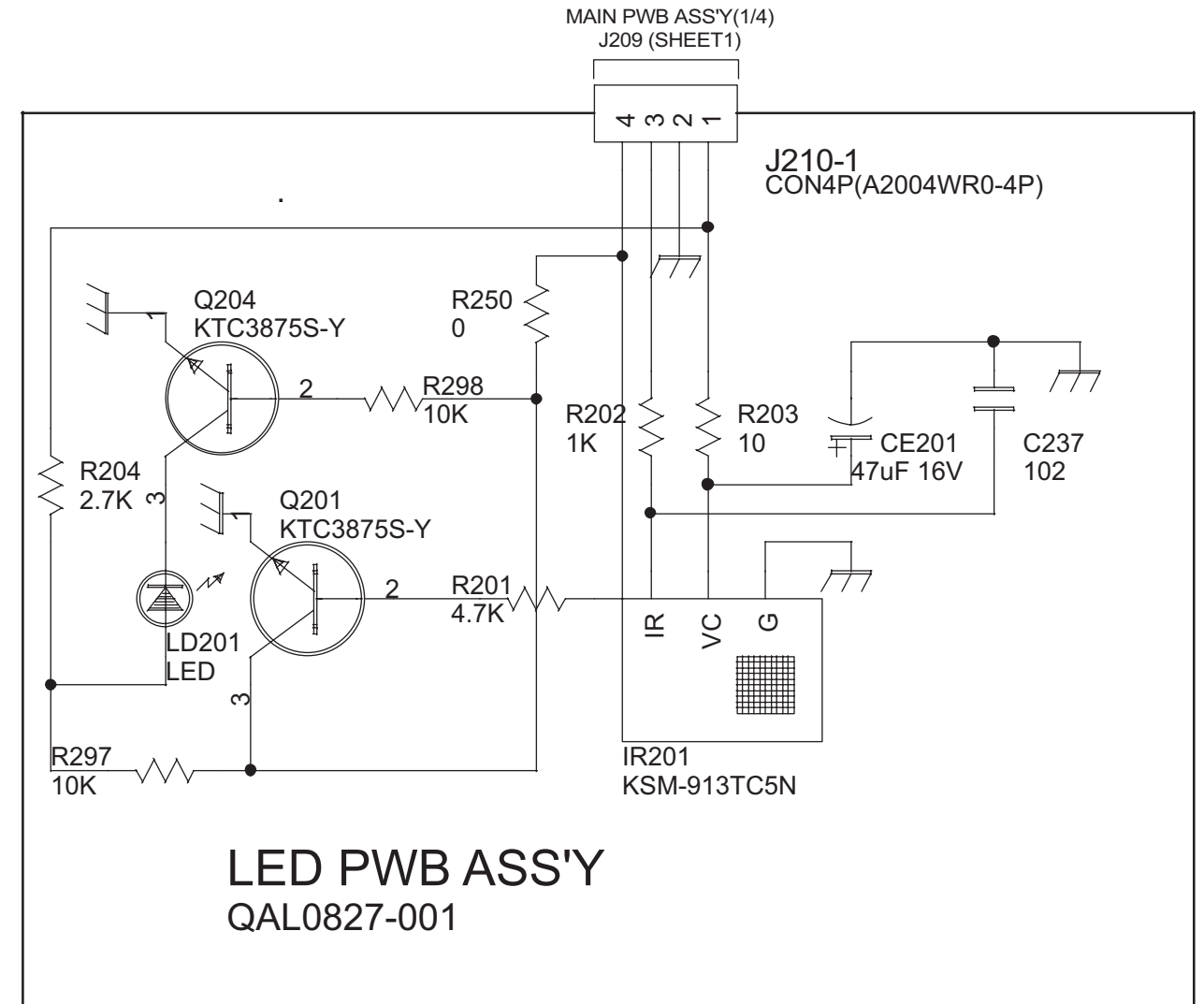
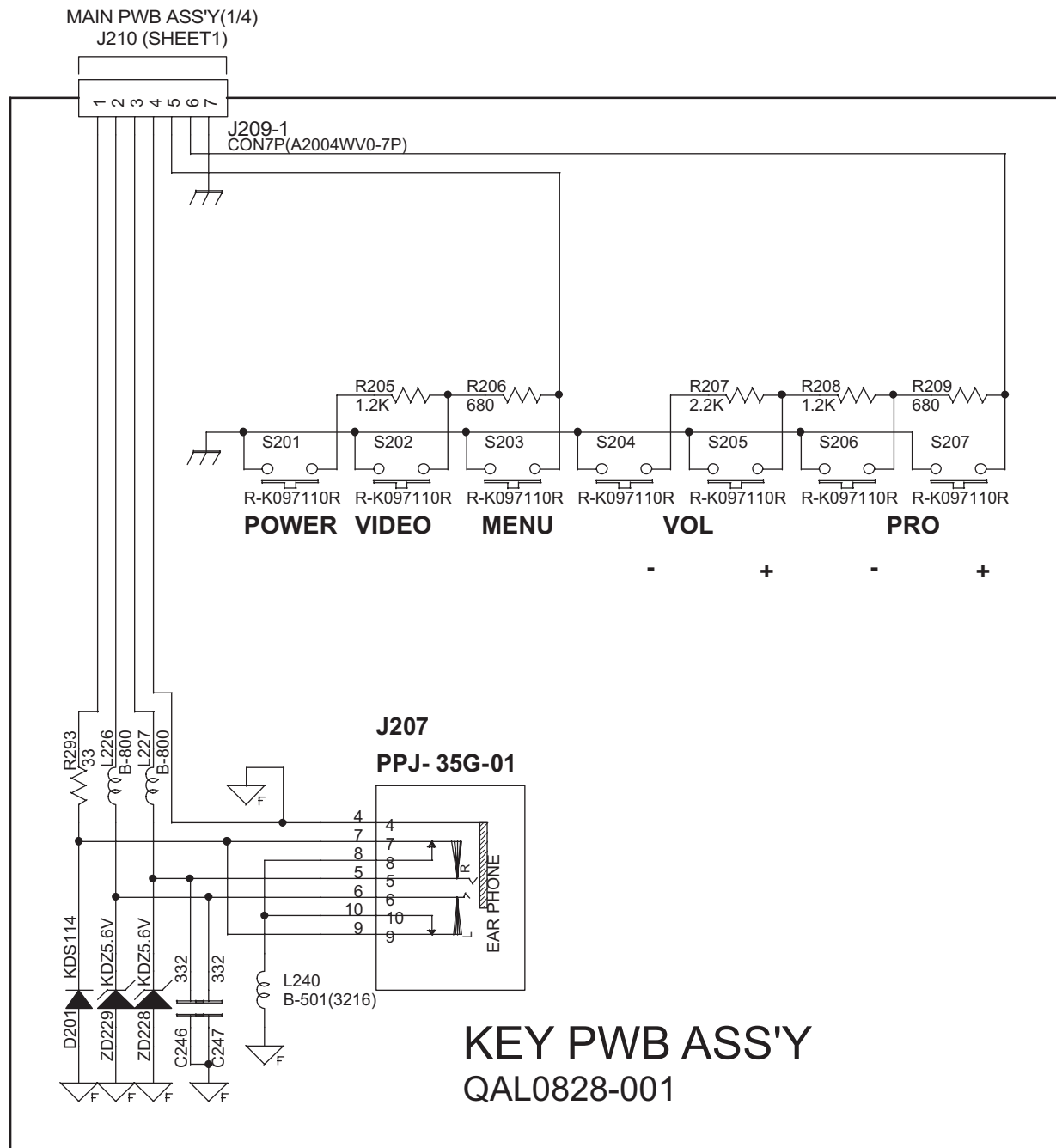

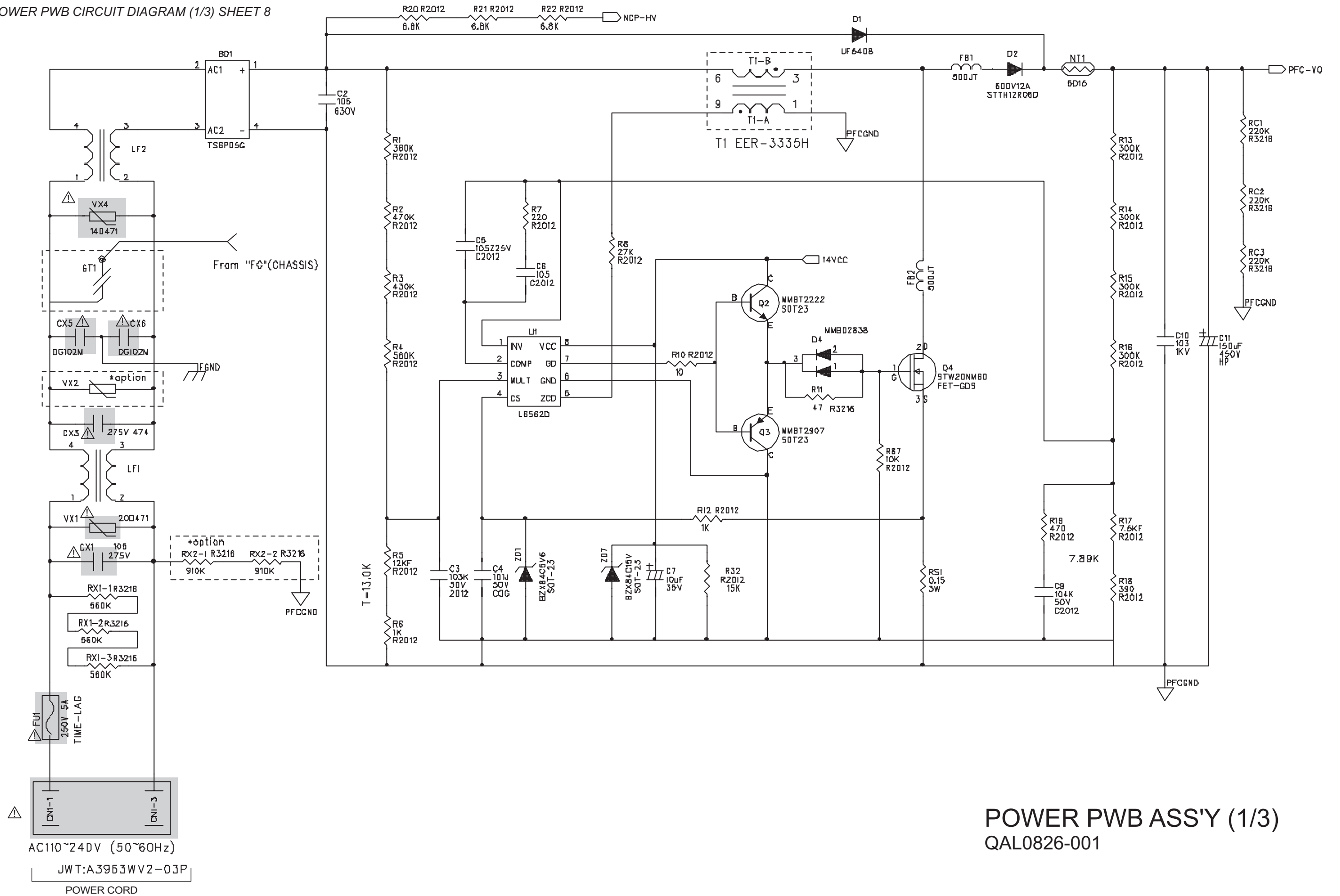

POWER PWB ASS'Y (1/3)
QAL0826-001

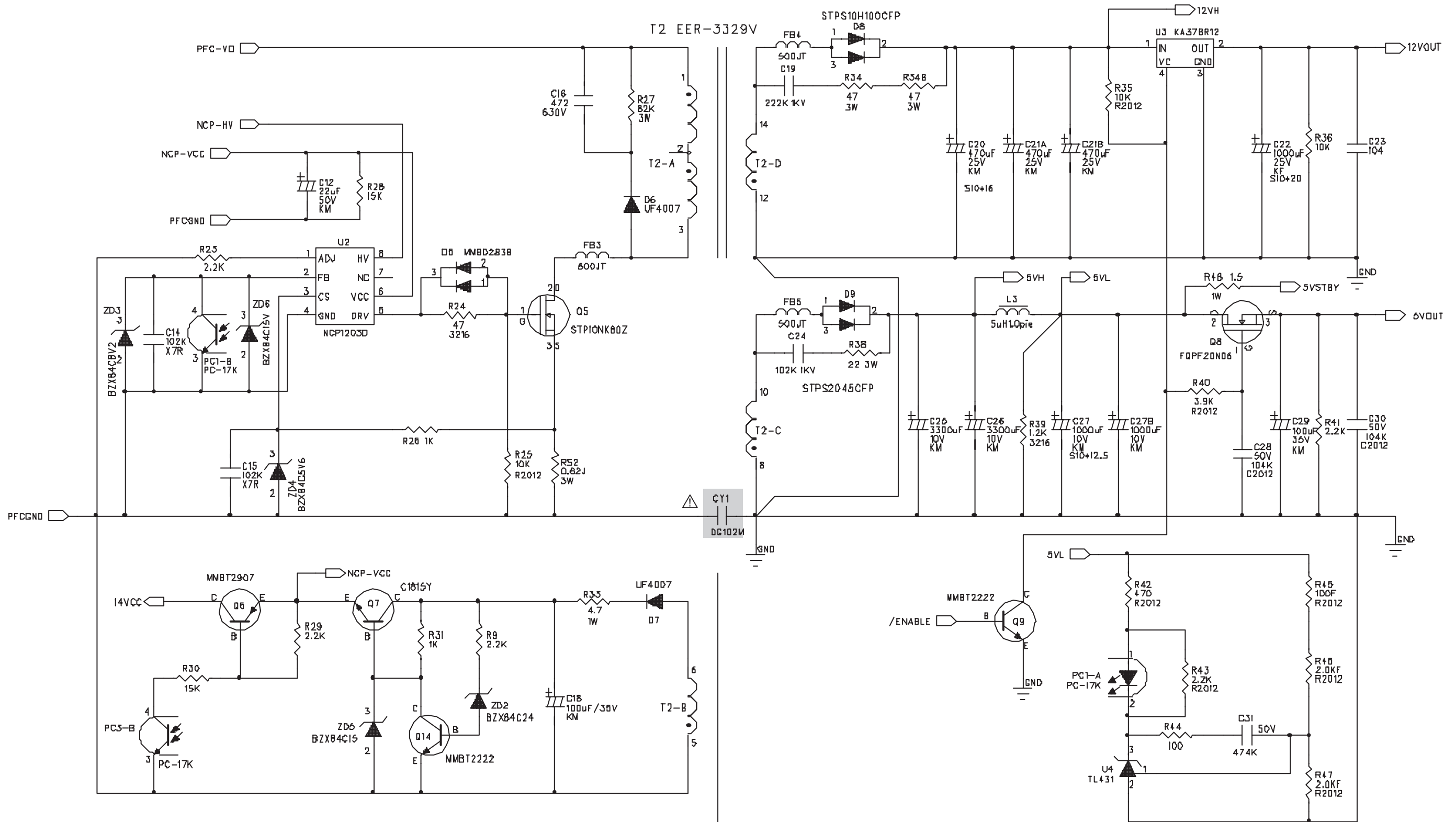

POWER PWB ASS'Y (2/3)
QAL0826-001

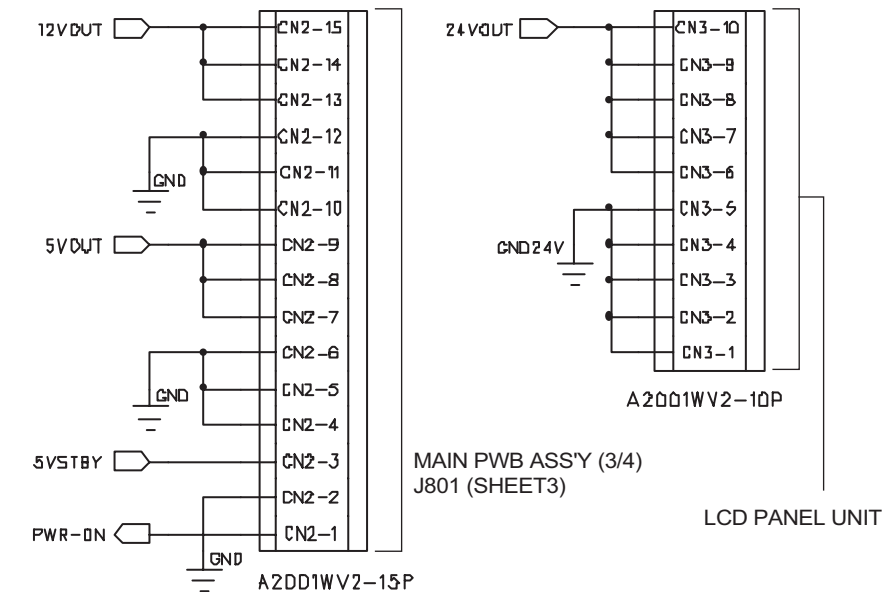
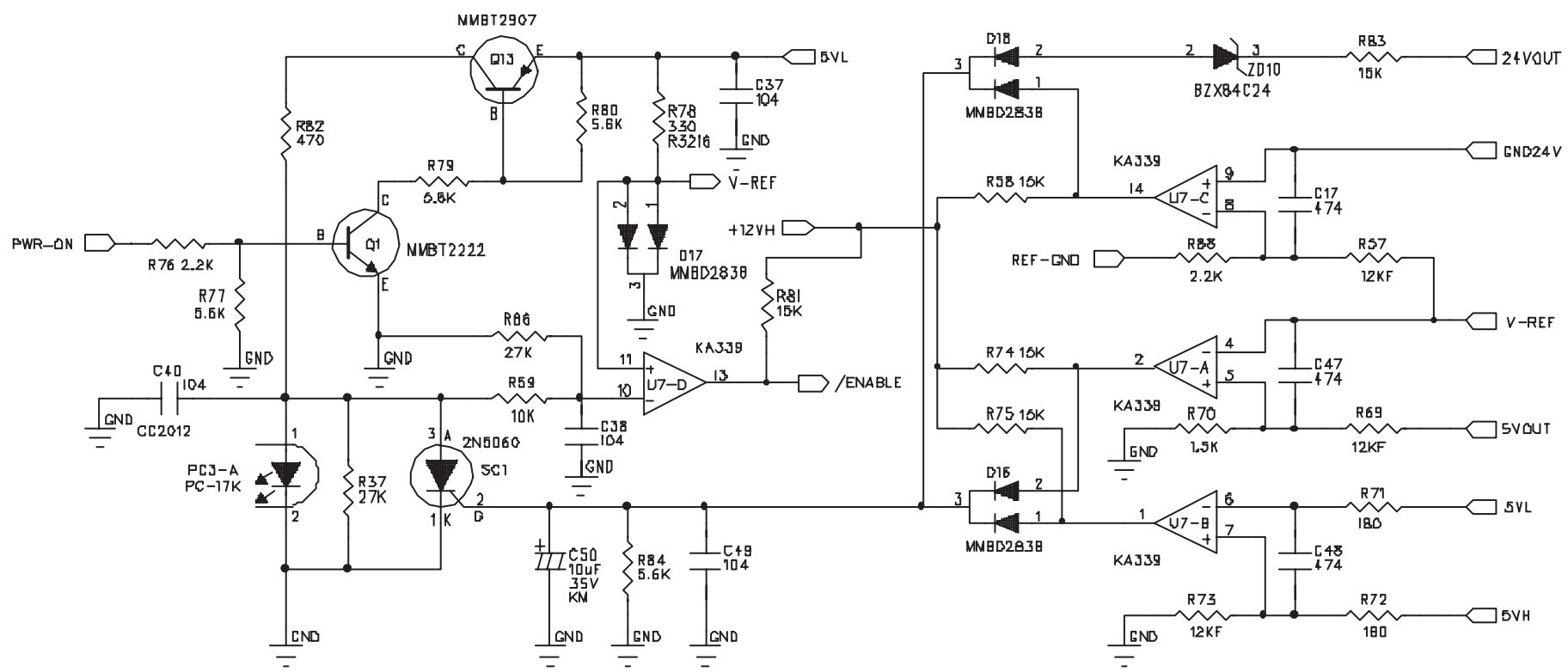
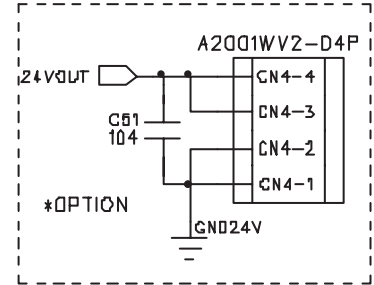
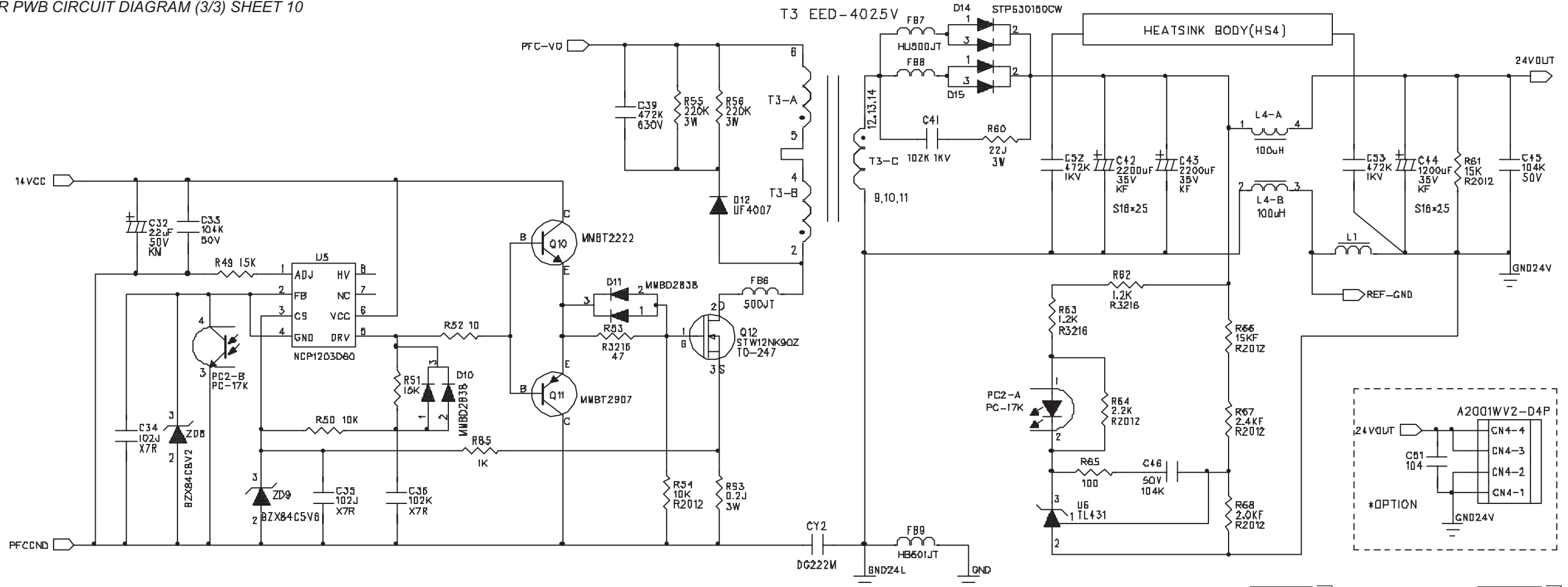

POWER PWB ASS'Y (3/3)
QAL0826-001

PATTERN DIAGRAMS
MAIN PWB PATTERN [SOLDER SIDE]

TOP
↑

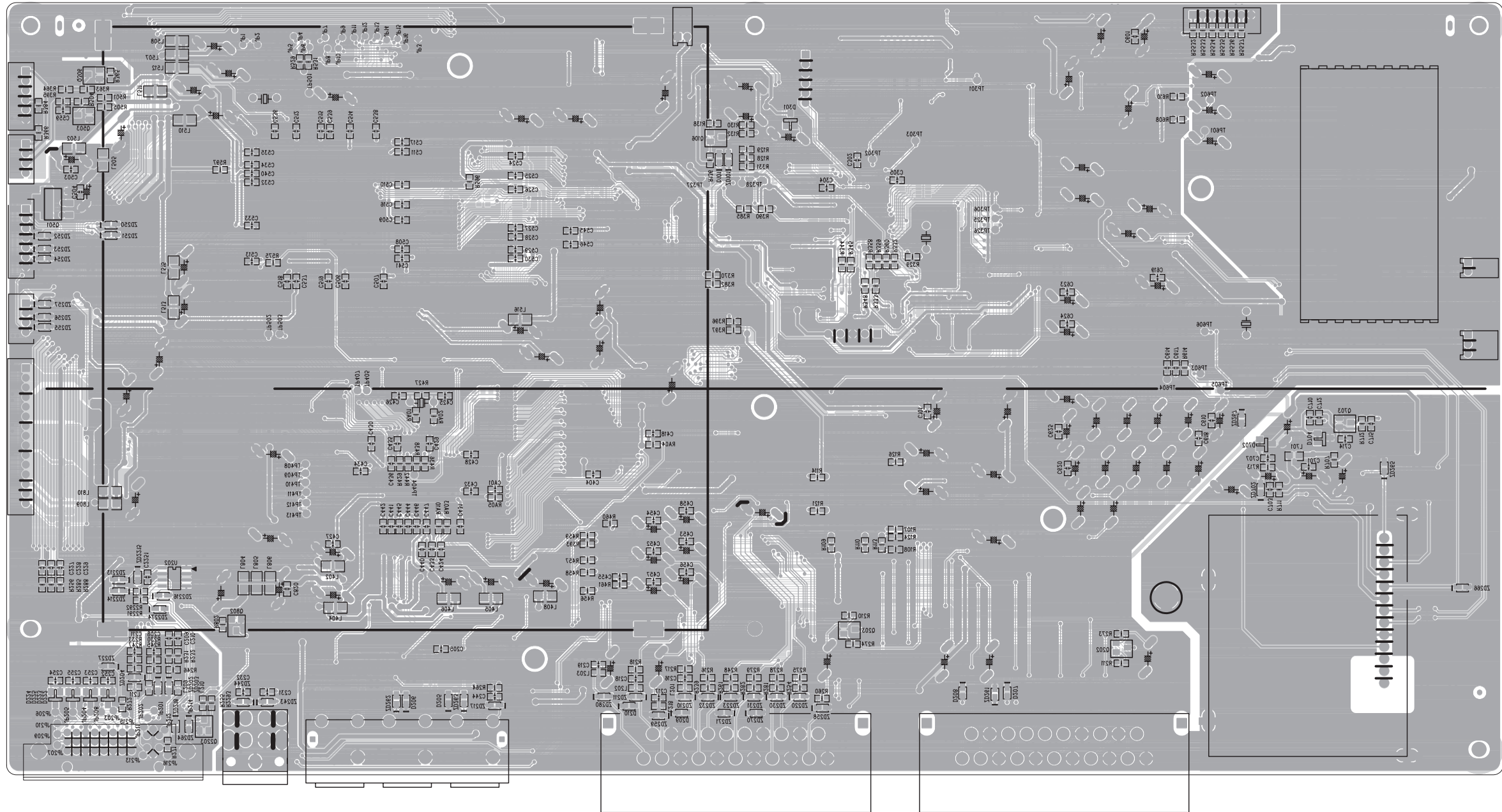

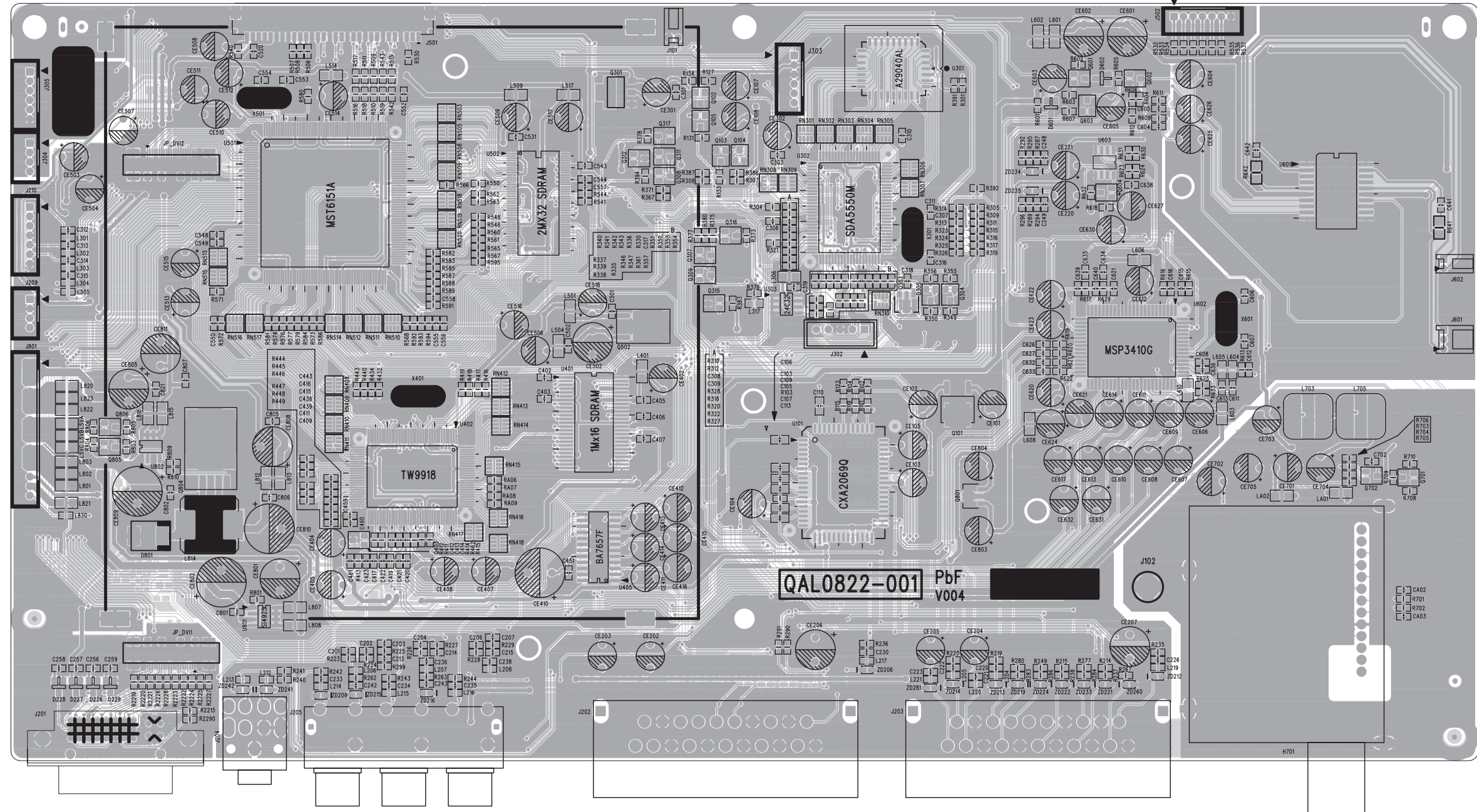

POWER PWB PATTERN [SOLDER SIDE]

TOP
←

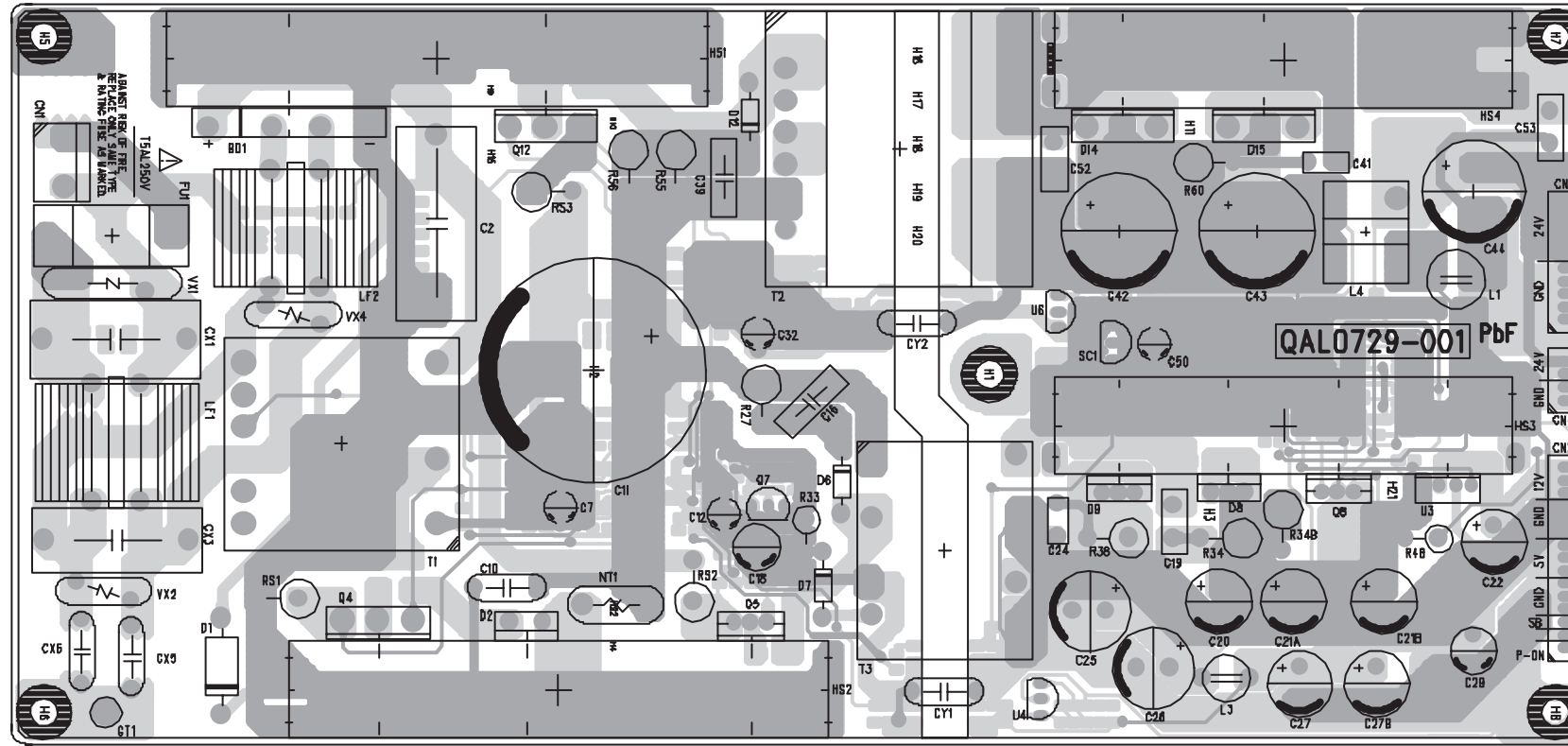

POWER PWB PATTERN [PARTS SIDE]

TOP
→

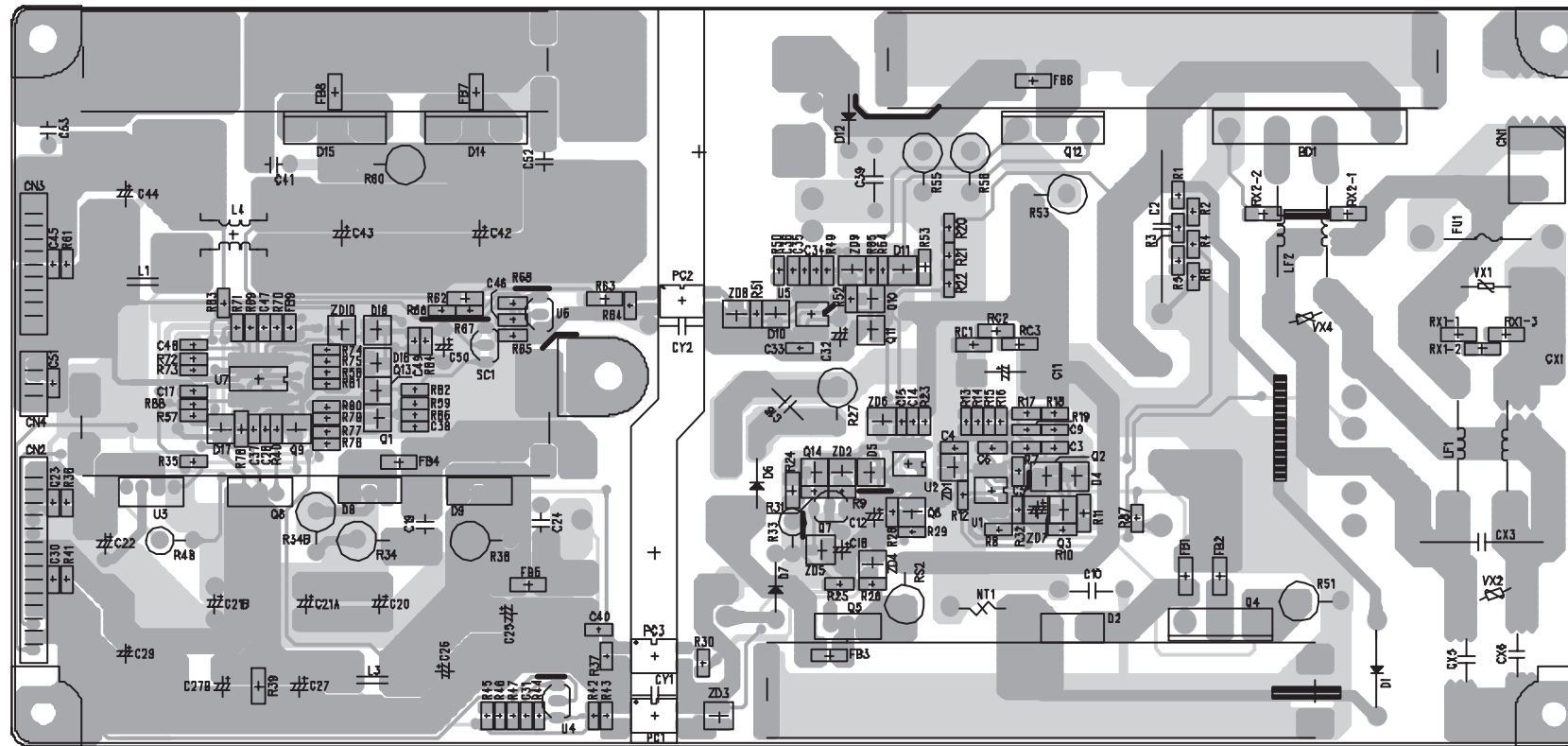

KEY PWB PATTERN [SOLDER SIDE]

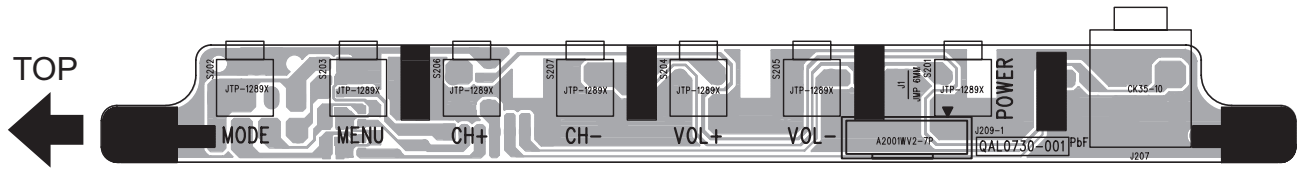

KEY PWB PATTERN [PARTS SIDE]

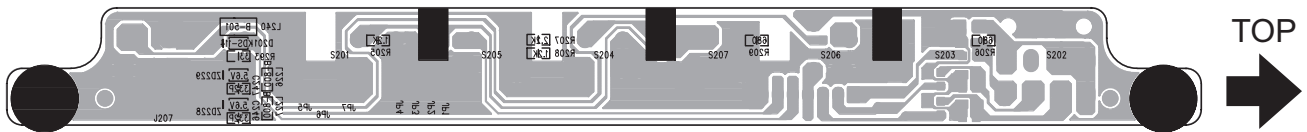

LED PWB PATTERN [SOLDER SIDE]

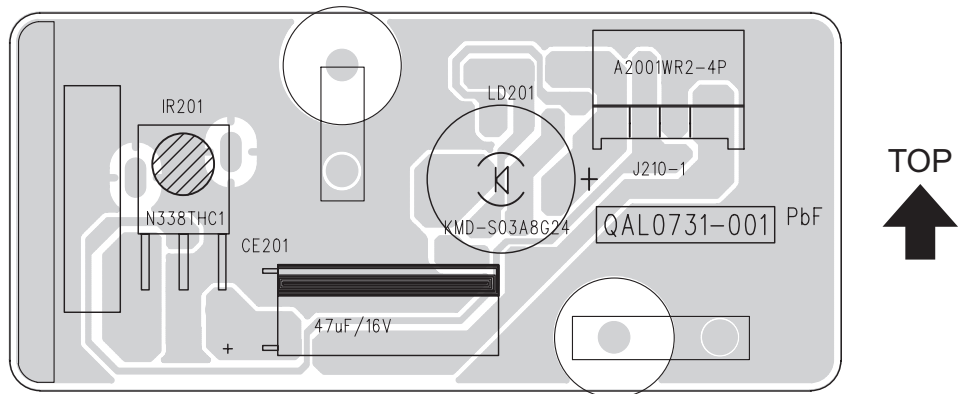

LED PWB PATTERN [PARTS SIDE]

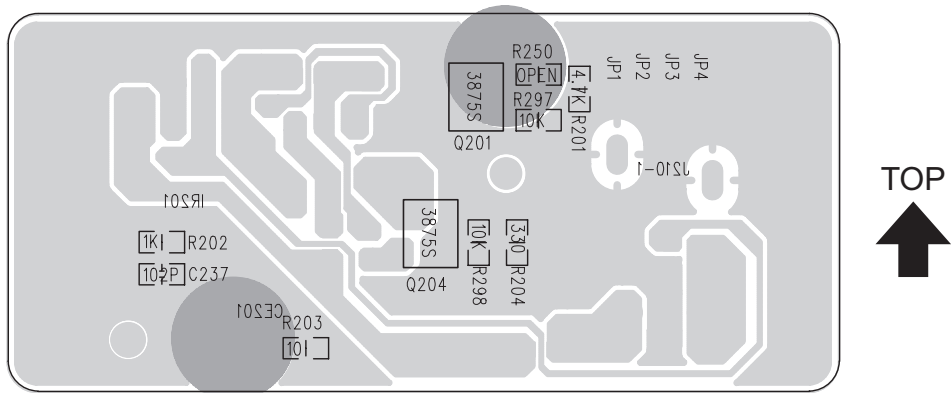

WAVEFORMS

MAIN PWB (1/4)
(SHEET1)

U302-21

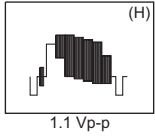

U302-29

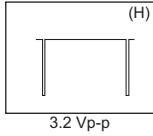

U302-30

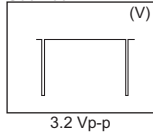

U302-52

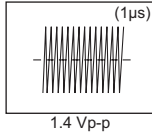

U302-53

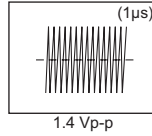

U402-15

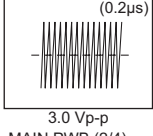

U402-16

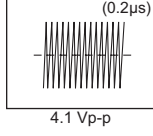

U402-19

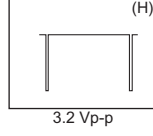

U402-20

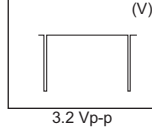

U402-61

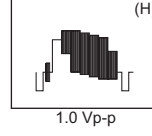

MAIN PWB (2/4)
(SHEET2)

U501-51

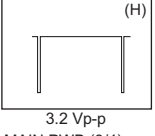

U501-53

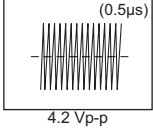

U501-77

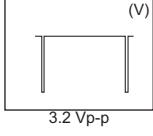

U501-202

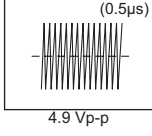

U501-203

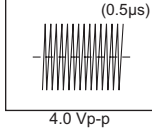

U602-71

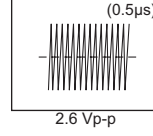

U602-72

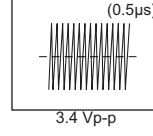

MAIN PWB (3/4)
(SHEET3)

U101-41

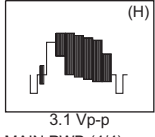

U101-44

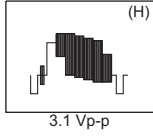

U101-53

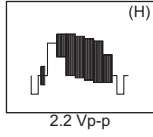

U101-63

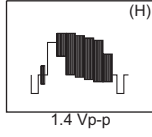

MAIN PWB (4/4)
(SHEET4)

H701-17

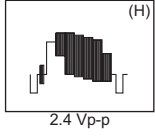



JVC

Victor Company of Japan, Limited
Flat Panel Display Category 12, 3-chome, Moriya-cho, Kanagawa-ku, Yokohama-city, Kanagawa-prefecture, 221-8528, Japan

(No.YA369)

PARTS LIST

CAUTION

- The parts identified by the Δ symbol are important for the safety . Whenever replacing these parts, be sure to use specified ones to secure the safety.
- The parts not indicated in this Parts List and those which are filled with lines --- in the Parts No. columns will not be supplied.
- P.W. BOARD Ass'y will not be supplied, but those which are filled with the Parts No. in the Parts No. columns will be supplied.

ABBREVIATIONS OF RESISTORS, CAPACITORS AND TOLERANCES

RESISTORS		CAPACITORS	
CR	Carbon Resistor	C CAP.	Ceramic Capacitor
FR	Fusible Resistor	E CAP.	Electrolytic Capacitor
PR	Plate Resistor	M CAP.	Mylar Capacitor
VR	Variable Resistor	CH CAP.	Chip Capacitor
HV R	High Voltage Resistor	HV CAP.	High Voltage Capacitor
MF R	Metal Film Resistor	MF CAP.	Metalized Film Capacitor
MG R	Metal Glazed Resistor	MM CAP.	Metalized Mylar Capacitor
MP R	Metal Plate Resistor	MP CAP.	Metalized Polystyrol Capacitor
OM R	Metal Oxide Film Resistor	PP CAP.	Polypropylene Capacitor
CMF R	Coating Metal Film Resistor	PS CAP.	Polystyrol Capacitor
UNF R	Non-Flammable Resistor	TF CAP.	Thin Film Capacitor
CH V R	Chip Variable Resistor	MPP CAP.	Metalized Polypropylene Capacitor
CH MG R	Chip Metal Glazed Resistor	TAN. CAP.	Tantalum Capacitor
COMP. R	Composition Resistor	CH C CAP.	Chip Ceramic Capacitor
LPTC R	Linear Positive Temperature Coefficient Resistor	BP E CAP.	Bi-Polar Electrolytic Capacitor
		CH AL E CAP.	Chip Aluminum Electrolytic Capacitor
		CH AL BP CAP.	Chip Aluminum Bi-Polar Capacitor
		CH TAN. E CAP.	Chip Tantalum Electrolytic Capacitor
		CH AL BP E CAP.	Chip Tantalum Bi-Polar Electrolytic Capacitor

RESISTORS									
F	G	J	K	M	N	R	H	Z	P
±1%	±2%	±5%	±10%	±20%	±30%	+30% -10%	+50% -10%	+80% -20%	+100% -0%

CONTENTS

USING P.W. BOARD & REMOTE CONTROL UNIT	3-3
EXPLODED VIEW PARTS LIST	3-4
EXPLODED VIEW	3-5
PRINTED WIRING BOARD PARTS LIST [LT-26A61BJ, LT-26A61BU, LT-26A61BU/C, LT-26A61SU/C]	3-6
MAIN P.W. BOARD ASS'Y (QAL0823-001)	3-6
POWER P.W. BOARD ASS'Y (QAL0826-001)	3-10
LED P.W. BOARD ASS'Y (QAL0827-001)	3-12
KEY P.W. BOARD ASS'Y (QAL0828-001)	3-12
PRINTED WIRING BOARD PARTS LIST [LT-26A61SJ, LT-26A61SU]	3-13
MAIN P.W. BOARD ASS'Y (QAL0822-001)	3-13
POWER P.W. BOARD ASS'Y (QAL0826-001)	3-17
LED P.W. BOARD ASS'Y (QAL0827-001)	3-17
KEY P.W. BOARD ASS'Y (QAL0828-001)	3-17
PRINTED WIRING BOARD PARTS LIST [LT-32A61BJ, LT-32A61BU, LT-32A61SU/C]	3-18
MAIN P.W. BOARD ASS'Y (QAL0825-001)	3-18
POWER P.W. BOARD ASS'Y (QAL0826-001)	3-22
LED P.W. BOARD ASS'Y (QAL0827-001)	3-22
KEY P.W. BOARD ASS'Y (QAL0828-001)	3-22
PRINTED WIRING BOARD PARTS LIST [LT-32A61BU/C, LT-32A61SJ, LT-32A61SU]	3-23
MAIN P.W. BOARD ASS'Y (QAL0824-001)	3-23
POWER P.W. BOARD ASS'Y (QAL0826-001)	3-27
LED P.W. BOARD ASS'Y (QAL0827-001)	3-27
KEY P.W. BOARD ASS'Y (QAL0828-001)	3-27
REMOTE CONTROL UNIT PARTS LIST (RM-C1816S-2C)	3-28
PACKING	3-28
PACKING PARTS LIST	3-28

USING P.W. BOARD & REMOTE CONTROL UNIT

P.W.B ASS'Y name	P.W.B ASS'Y No.					
	LT-26A61BJ	LT-26A61BU	LT-26A61BU/C	LT-26A61SJ	LT-26A61SU	LT-26A61SU/C
MAIN P.W.B	QAL0823-001	←	←	QAL0822-001	←	QAL0823-001
POWER P.W.B	QAL0826-001	←	←	←	←	←
LED P.W.B	QAL0827-001	←	←	←	←	←
KEY P.W.B	QAL0828-001	←	←	←	←	←
REMOTE CONTROL UNIT	RM-C1816S-2C	←	←	←	←	←

P.W.B ASS'Y name	P.W.B ASS'Y No.					
	LT-32A61BJ	LT-32A61BU	LT-32A61BU/C	LT-32A61SJ	LT-32A61SU	LT-32A61SU/C
MAIN P.W.B	QAL0825-001	←	QAL0824-001	←	←	QAL0825-001
POWER P.W.B	QAL0826-001	←	←	←	←	←
LED P.W.B	QAL0827-001	←	←	←	←	←
KEY P.W.B	QAL0828-001	←	←	←	←	←
REMOTE CONTROL UNIT	RM-C1816S-2C	←	←	←	←	←

EXPLODED VIEW PARTS LIST

Please note that the TUNER is not included in the MAIN PWB.

△	Ref.No.	Part No.	Part Name	Description	Local
△	101	LC12342-006A-U	TERMINAL COVER		LT-26A61BJ,LT-26A61BU,LT-26A61BU/C,LT-32A61BJ,LT-32A61BU,LT-32A61BU/C
△	101	LC12342-005A-U	TERMINAL COVER		LT-26A61SJ,LT-26A61SU,LT-26A61SU/C,LT-32A61SJ,LT-32A61SU,LT-32A61SU/C
	102	LC42230-004A-C	STAND ASSY		LT-26A61BJ,LT-26A61BU,LT-26A61BU/C,LT-32A61BJ,LT-32A61BU,LT-32A61BU/C
	102	LC42230-003A-C	STAND ASSY		LT-26A61SJ,LT-26A61SU,LT-26A61SU/C,LT-32A61SJ,LT-32A61SU
	102	GA10161-001A-U	STAND ASSY		LT-26A61SU/C,LT-32A61SU/C
	103	GA30080-002A-U	STAND COVER		LT-26A61BJ,LT-26A61BU,LT-26A61BU/C,LT-32A61BJ,LT-32A61BU,LT-32A61BU/C
	103	GA30080-001A-U	STAND COVER		LT-26A61SJ,LT-26A61SU,LT-26A61SU/C,LT-32A61SJ,LT-32A61SU,LT-32A61SU/C
	104	GA30081-002A-U	CABLE COVER		LT-26A61BJ,LT-26A61BU,LT-26A61BU/C,LT-32A61BJ,LT-32A61BU,LT-32A61BU/C
	104	GA30081-001A-U	CABLE COVER		LT-26A61SJ,LT-26A61SU,LT-26A61SU/C,LT-32A61SJ,LT-32A61SU,LT-32A61SU/C
	105	QYSDSP4008MA	SCREW	M4 x 8mm(x4)	
	106	QYSPSPD5020ZA	SCREW	M5 x 20mm(x4)	
△	107	LC12341-006A-U	REAR COVER		LT-26A61BJ,LT-26A61BU,LT-26A61BU/C
△	107	LC12341-005A-U	REAR COVER		LT-26A61SJ,LT-26A61SU,LT-26A61SU/C
△	107	LC12396-006A-U	REAR COVER		LT-32A61BJ,LT-32A61BU,LT-32A61BU/C
△	107	LC12396-005A-U	REAR COVER		LT-32A61SJ,LT-32A61SU,LT-32A61SU/C
	108	QYSBSF4012ZA	TAP SCREW	M4 x 12mm(x8)	
	109	LC42446-001A	SCREW		LT-26A61BJ,LT-26A61SU/C,LT-32A61BJ,LT-32A61SU/C
	109	LC42063-001A	SCREW		LT-26A61BU,LT-26A61BU/C,LT-26A61SJ,LT-26A61SU,LT-32A61BU,LT-32A61BU/C,LT-32A61SJ,LT-32A61SU
	110	LC42446-001A	SCREW	(x2)	LT-26A61BJ,LT-26A61SU/C,LT-32A61BJ,LT-32A61SU/C
	110	LC42063-001A	SCREW	(x2)	LT-26A61BU,LT-26A61BU/C,LT-26A61SJ,LT-26A61SU,LT-32A61BU,LT-32A61BU/C,LT-32A61SJ,LT-32A61SU
△	111	QMPN260-170-JC	POWER CORD(EK)	1.7m BLACK	LT-26A61BJ,LT-26A61SJ,LT-32A61BJ,LT-32A61SJ
△	111	QMPK300-170-JC	POWER CORD(EU)	1.7m BLACK	LT-26A61BU,LT-26A61BU/C,LT-26A61SU,LT-26A61SU/C,LT-32A61BU,LT-32A61BU/C,LT-32A61SJ,LT-32A61SU
	112	QQR0491-002	FERRITE CORE		
	113	QQR0491-001	FERRITE CORE		LT-32A61BJ,LT-32A61BU,LT-32A61SU,LT-32A61SU/C
	114	LC42388-001B	CONN ACCESSORY	(x2)	LT-26A61BJ,LT-26A61SU/C,LT-32A61BJ,LT-32A61SU/C
	114	LC42388-001A	CONN ACCESSORY	(x2)	LT-26A61BU,LT-26A61BU/C,LT-26A61SJ,LT-26A61SU,LT-32A61BU,LT-32A61BU/C,LT-32A61SJ
	114	QNB0036-001	CONN ACCESSORY	(x2)	LT-32A61BU,LT-32A61SU
	115	QQR0491-001	FERRITE CORE	(x2)	
	116	QQR0490-001	NOISE FILTER	(x4)	
	117	QQR0491-001	FERRITE CORE		LT-26A61BJ,LT-26A61BU,LT-26A61BU/C,LT-26A61SJ,LT-26A61SU,LT-26A61SU/C
△	118	LC12387-004A-U	TERMINAL BASE		LT-26A61BJ,LT-26A61BU,LT-26A61BU/C,LT-26A61SJ,LT-26A61SU,LT-26A61SU/C
△	118	LC12387-003A-U	TERMINAL BASE		LT-26A61BJ,LT-26A61BU,LT-26A61BU/C,LT-32A61BJ,LT-32A61BU,LT-32A61BU/C
	119	QYSBSF3010ZA	TAP SCREW	M3 x 10mm	LT-26A61SJ,LT-26A61SU,LT-26A61SU/C,LT-32A61SJ,LT-32A61SU,LT-32A61SU/C
	120	LC42301-001A	SCREW	(x4)	
△	121	QLD0408-001-JUK	LCD PANEL UNIT		LT-26A61BJ,LT-26A61BU,LT-26A61SU/C
△	121	QLD0370-002-JUK	LCD PANEL UNIT		LT-26A61BU/C,LT-26A61SJ,LT-26A61SU
△	121	QLD0409-001-JUK	LCD PANEL UNIT		LT-32A61BJ,LT-32A61BU,LT-32A61SU/C
△	121	QLD0371-001-JUK	LCD PANEL UNIT		LT-32A61BU/C,LT-32A61SJ,LT-32A61SU
	122	LC42239-001A-C	SPEAKER ASSY	LEFT	LT-26A61BJ,LT-26A61BU,LT-26A61BU/C,LT-26A61SJ,LT-26A61SU,LT-26A61SU/C
	122	LC42239-003A-C	SPEAKER ASSY	LEFT	LT-32A61BJ,LT-32A61BU,LT-32A61BU/C,LT-32A61SJ,LT-32A61SU,LT-32A61SU/C
	123	LC42239-002A-C	SPEAKER ASSY	RIGHT	LT-26A61BJ,LT-26A61BU,LT-26A61BU/C,LT-26A61SJ,LT-26A61SU,LT-26A61SU/C
	123	LC42239-004A-C	SPEAKER ASSY	RIGHT	LT-32A61BJ,LT-32A61BU,LT-32A61BU/C,LT-32A61SJ,LT-32A61SU,LT-32A61SU/C
	124	LC40226-005A-H	SPACER	(x6)	
	125	LC12467-001A-U	KNOB BASE		LT-26A61BJ,LT-26A61BU,LT-26A61BU/C,LT-32A61BJ,LT-32A61BU,LT-32A61BU/C
	125	LC12467-002A-U	KNOB BASE		LT-26A61SJ,LT-26A61SU,LT-26A61SU/C,LT-32A61SJ,LT-32A61SU,LT-32A61SU/C
△	126	LC12340-006A-U	FRONT PANEL		LT-26A61BJ,LT-26A61BU,LT-26A61BU/C
△	126	LC12340-005A-U	FRONT PANEL		LT-26A61SJ,LT-26A61SU,LT-26A61SU/C
△	126	LC12395-006A-U	FRONT PANEL		LT-32A61BJ,LT-32A61BU,LT-32A61BU/C
△	126	LC12395-005A-U	FRONT PANEL		LT-32A61SJ,LT-32A61SU,LT-32A61SU/C
	127	LC41852-001A	JVC MARK ASSY		
	128	LC42247-001D	LED PLATE		LT-26A61BJ,LT-26A61BU,LT-26A61BU/C,LT-32A61BJ,LT-32A61BU,LT-32A61BU/C
	128	LC42247-002B	LED PLATE		LT-26A61SJ,LT-26A61SU,LT-26A61SU/C,LT-32A61SJ,LT-32A61SU,LT-32A61SU/C
	129	WJW0027-001A-E	DIGITAL(LVDS) CABLE		LT-26A61BJ,LT-26A61BU,LT-26A61BU/C,LT-26A61SJ,LT-26A61SU,LT-26A61SU/C
	129	WJW0027-002A-E	DIGITAL(LVDS) CABLE		LT-32A61BJ,LT-32A61BU,LT-32A61BU/C,LT-32A61SJ,LT-32A61SU,LT-32A61SU/C
	130	QAU0459-001	TUNER		
△	201	QAL0826-001	POWER PWB		
△	202	QAL0822-001	MAIN PWB		LT-26A61SJ,LT-26A61SU
△	202	QAL0823-001	MAIN PWB		LT-26A61BJ,LT-26A61BU,LT-26A61BU/C,LT-26A61SU/C
△	202	QAL0824-001	MAIN PWB		LT-32A61BU/C,LT-32A61SJ,LT-32A61SU
△	202	QAL0825-001	MAIN PWB		LT-32A61BJ,LT-32A61BU,LT-32A61SU/C
△	203	QAL0828-001	KEY PWB		
△	204	QAL0827-001	LED PWB		

EXPLODED VIEW

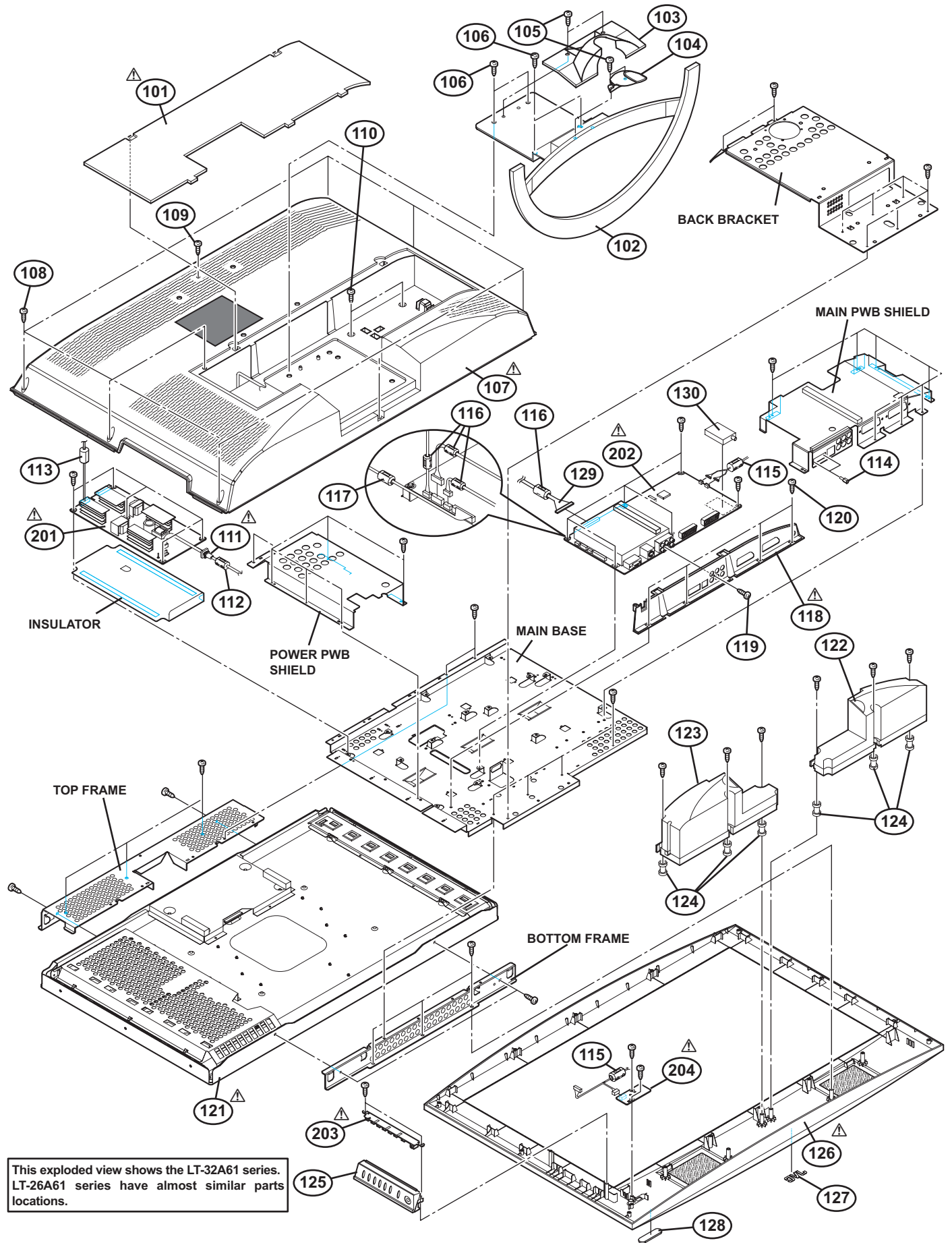

This exploded view shows the LT-32A61 series. LT-26A61 series have almost similar parts locations.

PRINTED WIRING BOARD PARTS LIST [LT-26A61BJ, LT-26A61BU, LT-26A61BU_C, LT-26A61SU_C]

MAIN P.W. BOARD ASS'Y (QAL0823-001)

△Ref No.	Part No.	Part Name	Description Local	△Ref No.	Part No.	Part Name	Description Local
U101	T1001-00081A	IC		ZD216	T2901-HC011A	Z DIODE	
U202	ATF02-26A61BJ	IC	(SERVICE)	ZD217	T2901-HC011A	Z DIODE	
U301	T1001-00073A-61	IC		ZD218	T2901-HC011A	Z DIODE	
U302	T1001-00064A	IC		ZD219	T2901-JC005A	Z DIODE	
U303	ATF32-26A61BJ	IC	(SERVICE)	ZD221	T2901-JC005A	Z DIODE	
U401	T1001-00084A	IC		ZD222	T2901-JC005A	Z DIODE	
U402	T1001-00085A	IC		ZD227	T2901-JC005A	Z DIODE	
U405	T1001-00075A	IC		ZD230	T2901-JC005A	Z DIODE	
U501	T1001-00086A	IC		ZD231	T2901-JC012B	Z DIODE	
U502	T1001-00063A	IC		ZD232	T2901-JC012B	Z DIODE	
U601	T1001-00087A	IC		ZD250	T2901-JC012B	Z DIODE	
U602	T1001-00088A	IC		ZD251	T2901-JC012B	Z DIODE	
U603	T1001-00070A	IC		ZD252	T2901-JC012B	Z DIODE	
U801	T0407-00004A	TRANSISTOR		ZD253	T2901-JC010B	Z DIODE	
U802	T0407-00004A	TRANSISTOR		ZD254	T2901-JC010B	Z DIODE	
Q101	T1001-00052A	IC		ZD255	T2901-JC010B	Z DIODE	
Q102	T0507-00001A	TRANSISTOR		ZD256	T2901-JC010B	Z DIODE	
Q103	T0507-00001A	TRANSISTOR		ZD257	T2901-JC010B	Z DIODE	
Q104	T0507-00001A	TRANSISTOR		ZD258	T2901-JC004A	Z DIODE	
Q105	T0507-00006A	TRANSISTOR		ZD259	T2901-JC004A	Z DIODE	
Q106	T0507-00001A	TRANSISTOR		ZD260	T2901-JC004A	Z DIODE	
Q202	T0507-00001A	TRANSISTOR		ZD261	T2901-JC004A	Z DIODE	
Q203	T0507-00005A	TRANSISTOR		ZD262	T2901-JC004A	Z DIODE	
Q301	T1001-00049A	IC		ZD263	T2703-KC007A	Z DIODE	
Q303	T1001-00078A	IC		ZD264	T2703-KC007A	Z DIODE	
Q304	T0507-00003A	TRANSISTOR		ZD267	T2703-KC007A	Z DIODE	
Q305	T0507-00003A	TRANSISTOR		ZD270	T2703-KC007A	Z DIODE	
Q306	T0507-00007A	TRANSISTOR		ZD271	T2703-KC007A	Z DIODE	
Q307	T0407-00003A	TRANSISTOR		ZD280	T2703-KC014A	Z DIODE	
Q308	T0507-00005A	TRANSISTOR		ZD281	T2703-KC014A	Z DIODE	
Q309	T0507-00005A	TRANSISTOR		ZD702	T2703-JC011A	DIODE	
Q311	T0507-00005A	TRANSISTOR		ZD2213	T2703-KC014A	Z DIODE	
Q312	T0507-00006A	TRANSISTOR		ZD2214	T2703-KC014A	Z DIODE	
Q315	T0507-00006A	TRANSISTOR		ZD2215	T2703-KC014A	Z DIODE	
Q316	T0507-00005A	TRANSISTOR		ZD2216	T2703-LC010A	Z DIODE	
Q317	T0407-00003A	TRANSISTOR		ZD2274	T2703-LC010A	Z DIODE	
Q403	T0507-00006A	TRANSISTOR		C101	T0407-00002A	C CAPACITOR	100nF 25V K
Q501	T1001-00079A	IC		C103	2007-000094	C CAPACITOR	10uF 10V Z
Q502	T1001-00048A	IC		C105	2007-000093	C CAPACITOR	100nF 50V Z
Q503	T0507-00007A	TRANSISTOR		C106	2007-000094	C CAPACITOR	10uF 10V Z
Q601	T0507-00006A	TRANSISTOR		C107	2007-000094	C CAPACITOR	10uF 10V Z
Q602	T0507-00002A	TRANSISTOR		C109	2007-000094	C CAPACITOR	10uF 10V Z
Q603	T0507-00002A	TRANSISTOR		C110	2007-000094	C CAPACITOR	10uF 10V Z
Q604	T0407-00002A	TRANSISTOR		C113	2007-000129	C CAPACITOR	10uF 10V Z
Q701	T0507-00002A	TRANSISTOR		C201	T0507-00005A	C CAPACITOR	1nF 50V K
Q702	T0507-00002A	TRANSISTOR		C202	2007-000081	C CAPACITOR	47nF 50V K
Q703	T0507-00002A	TRANSISTOR		C203	2007-000081	C CAPACITOR	47nF 50V K
Q801	T1001-00089A	IC		C204	2007-000081	C CAPACITOR	47nF 50V K
Q802	T0507-00008A	TRANSISTOR		C205	2007-000081	C CAPACITOR	47nF 50V K
Q804	T1001-00051A	IC		C206	2007-000081	C CAPACITOR	47nF 50V K
Q805	T0507-00008A	TRANSISTOR		C207	2007-000082	C CAPACITOR	47nF 50V K
Q806	T0507-00008A	TRANSISTOR		C208	2007-000082	C CAPACITOR	47nF 50V K
Q2203	T0407-00002A	TRANSISTOR		C209	2007-000082	C CAPACITOR	47nF 50V K
D101	T0408-00002A	DIODE		C210	T0507-00005A	C CAPACITOR	1nF 50V K
D205	T2703-IC002A	Z DIODE		C211	2007-000082	C CAPACITOR	47nF 50V K
D206	T2703-IC002A	Z DIODE		C213	T1001-00089A	C CAPACITOR	10pF 50V K
D207	T2703-IC002A	Z DIODE		C214	T1001-00089A	C CAPACITOR	10pF 50V K
D208	T2703-IC002A	Z DIODE		C215	T1001-00089A	C CAPACITOR	10pF 50V K
D209	T2703-IC002A	Z DIODE		C216	2007-000120	C CAPACITOR	0.47nF 50V K
D210	T2703-IC002A	Z DIODE		C218	2007-000120	C CAPACITOR	0.47nF 50V K
D222	2007-000070	DIODE		C219	2007-000120	C CAPACITOR	0.47nF 50V K
D223	2007-000070	DIODE		C220	2007-000120	C CAPACITOR	0.47nF 50V K
D224	2007-000070	DIODE		C221	2007-000120	C CAPACITOR	0.47nF 50V K
D225	2007-000070	DIODE		C222	2007-000121	C CAPACITOR	0.47nF 50V K
D226	2007-000070	DIODE		C223	2007-000121	C CAPACITOR	0.47nF 50V K
D227	2007-000882	DIODE		C226	2007-000121	C CAPACITOR	0.47nF 50V K
D228	2007-000882	DIODE		C227	2007-000082	C CAPACITOR	47nF 50V K
D229	2007-000882	DIODE		C228	2007-000084	C CAPACITOR	47nF 50V K
D301	T0408-00002A	DIODE		C229	2007-000084	C CAPACITOR	47nF 50V K
D601	T0408-00002A	DIODE		C230	2007-000121	C CAPACITOR	0.47nF 50V K
D602	T0408-00002A	DIODE		C233	2007-000121	C CAPACITOR	0.47nF 50V K
D702	T0408-00002A	DIODE		C234	2007-000078	C CAPACITOR	0.47nF 50V K
D704	T0408-00002A	DIODE		C235	2007-000078	C CAPACITOR	0.47nF 50V K
D801	T0407-00005A	DIODE		C236	T1001-00089A	C CAPACITOR	10pF 50V K
ZD101	T0408-000009A	Z DIODE		C238	T1001-00089A	C CAPACITOR	10pF 50V K
ZD202	T0408-000009A	Z DIODE		C242	2007-000643	C CAPACITOR	0.33nF 50V K
ZD203	T0408-000009A	Z DIODE		C243	2007-000643	C CAPACITOR	0.33nF 50V K
ZD204	T0408-000009A	Z DIODE		C244	2007-000643	C CAPACITOR	0.33nF 50V K
ZD206	T0408-000009A	Z DIODE		C248	2007-000077	C CAPACITOR	330nF 16V Z
ZD209	T2901-HC002A	Z DIODE		C249	2007-000077	C CAPACITOR	330nF 16V Z
ZD210	T2901-HC002A	Z DIODE		C252	T0407-00002A	C CAPACITOR	100nF 25V K
ZD211	T2901-HC002A	Z DIODE		C253	T0407-00002A	C CAPACITOR	100nF 25V K
ZD212	T2901-HC002A	Z DIODE		C254	T0407-00002A	C CAPACITOR	100nF 25V K
ZD213	T2901-HC002A	Z DIODE		C255	T0407-00002A	C CAPACITOR	100nF 25V K
ZD214	T2901-HC011A	Z DIODE		C256	T0407-00004A	C CAPACITOR	100nF 25V K
ZD215	T2901-HC011A	Z DIODE		C257	T0407-00004A	C CAPACITOR	100nF 25V K
				C258	T0407-00004A	C CAPACITOR	100nF 25V K
				C259	T0407-00004A	C CAPACITOR	100nF 25V K
				C301	T0407-00004A	C CAPACITOR	100nF 25V K

△Ref No.	Part No.	Part Name	Description Local	△Ref No.	Part No.	Part Name	Description Local
C302	T0407-00003A	C CAPACITOR	100nF 25V K	C528	T2703-IC002A	C CAPACITOR	100nF 25V K
C303	T0407-00003A	C CAPACITOR	100nF 25V K	C529	T2703-IC002A	C CAPACITOR	100nF 25V K
C304	T0407-00003A	C CAPACITOR	100nF 25V K	C530	T2703-IC002A	C CAPACITOR	100nF 25V K
C305	T0407-00003A	C CAPACITOR	100nF 25V K	C531	T2703-IC002A	C CAPACITOR	100nF 25V K
C306	2007-000074	C CAPACITOR	0.22nF 50V K	C532	T2703-IC002A	C CAPACITOR	100nF 25V K
C307	T0507-00002A	C CAPACITOR	10nF 50V K	C533	T2703-IC002A	C CAPACITOR	100nF 25V K
C308	2007-000075	C CAPACITOR	220nF 50V K	C534	T2703-IC002A	C CAPACITOR	100nF 25V K
C309	T0407-00003A	C CAPACITOR	100nF 25V K	C535	T2703-JC011A	C CAPACITOR	100nF 25V K
C310	T0408-00002A	C CAPACITOR	100nF 25V K	C536	T2703-JC011A	C CAPACITOR	100nF 25V K
C311	T0507-00007A	C CAPACITOR	33pF 50V K	C537	T2703-JC011A	C CAPACITOR	100nF 25V K
C312	T0507-00001A	C CAPACITOR	0.1nF 50V K	C538	T2703-JC011A	C CAPACITOR	100nF 25V K
C313	T0507-00001A	C CAPACITOR	0.1nF 50V K	C539	T2703-JC011A	C CAPACITOR	100nF 25V K
C314	T0507-00001A	C CAPACITOR	0.1nF 50V K	C540	2007-000070	C CAPACITOR	100nF 25V K
C316	T0507-00007A	C CAPACITOR	33pF 50V K	C541	2007-000070	C CAPACITOR	100nF 25V K
C317	T0408-00002A	C CAPACITOR	100nF 25V K	C543	2007-000070	C CAPACITOR	100nF 25V K
C318	T0408-00002A	C CAPACITOR	100nF 25V K	C544	2007-000070	C CAPACITOR	100nF 25V K
C319	T0408-00002A	C CAPACITOR	100nF 25V K	C545	2007-000070	C CAPACITOR	100nF 25V K
C402	T0408-00002A	C CAPACITOR	100nF 25V K	C546	2007-000882	C CAPACITOR	100nF 25V K
C403	T0408-00002A	C CAPACITOR	100nF 25V K	C548	2007-000882	C CAPACITOR	100nF 25V K
C404	T0408-00002A	C CAPACITOR	100nF 25V K	C549	2007-000882	C CAPACITOR	100nF 25V K
C405	T0408-00002A	C CAPACITOR	100nF 25V K	C550	T1001-00051A	C CAPACITOR	10pF 50V K
C406	T0408-00002A	C CAPACITOR	100nF 25V K	C552	2007-000882	C CAPACITOR	100nF 25V K
C407	T0408-00002A	C CAPACITOR	100nF 25V K	C553	T0507-00007A	C CAPACITOR	33pF 50V K
C409	T0407-00005A	C CAPACITOR	100nF 25V K	C554	T0507-00007A	C CAPACITOR	33pF 50V K
C411	T0407-00005A	C CAPACITOR	100nF 25V K	C555	2007-000882	C CAPACITOR	100nF 25V K
C412	T0407-00005A	C CAPACITOR	100nF 25V K	C556	T0507-00005A	C CAPACITOR	1nF 50V K
C413	T0407-00005A	C CAPACITOR	100nF 25V K	C557	T1001-00051A	C CAPACITOR	10pF 50V K
C414	T0407-00005A	C CAPACITOR	100nF 25V K	C559	2007-001134	C CAPACITOR	1uF 16V Z
C415	T0408-000009A	C CAPACITOR	100nF 25V K	C601	2007-000309	C CAPACITOR	100nF 25V K
C416	T0408-000009A	C CAPACITOR	100nF 25V K	C604	2007-000118	C CAPACITOR	3.3nF 50V K
C417	T0408-000009A	C CAPACITOR	100nF 25V K	C605	2007-000118	C CAPACITOR	3.3nF 50V K
C419	T0408-000009A	C CAPACITOR	100nF 25V K	C606	T1001-00048A	C CAPACITOR	6pF 50V K
C420	T0408-000009A	C CAPACITOR	100nF 25V K	C607	T1001-00048A	C CAPACITOR	6pF 50V K
C421	2007-000115	C CAPACITOR	1.5nF 50V K	C608	T0507-00006A	C CAPACITOR	47pF 50V K
C422	2007-000115	C CAPACITOR	1.5nF 50V K	C610	2007-000309	C CAPACITOR	100nF 25V K
C423	2007-000115	C CAPACITOR	1.5nF 50V K	C611	T0507-00006A	C CAPACITOR	47pF 50V K
C424	T0507-00001A	C CAPACITOR	0.1nF 50V K	C612	T2203-FC100D	C RESISTOR	0Ω 1/16W J
C425	T0507-00003A	C CAPACITOR	22pF 50V K	C614	2007-000123	C CAPACITOR	4.7nF 50V K
C426	T0507-00003A	C CAPACITOR	22pF 50V K	C615	2007-000643	C CAPACITOR	0.33nF 50V K
C427	T2901-HC002A	C CAPACITOR	100nF 25V K	C616	2007-000643	C CAPACITOR	0.33nF 50V K
C428	T2901-HC002A	C CAPACITOR	100nF 25V K	C617	2007-000309	C CAPACITOR	100nF 25V K
C429	T2901-HC002A	C CAPACITOR	100nF 25V K	C618	T0507-00002A	C CAPACITOR	10nF 50V K
C430	T2901-HC002A	C CAPACITOR	100nF 25V K	C619	T0507-00002A	C CAPACITOR	10nF 50V K
C431	T2901-HC002A	C CAPACITOR	100nF 25V K	C620	T0507-00002A	C CAPACITOR	10nF 50V K
C432	T2901-HC011A	C CAPACITOR	100nF 25V K	C621	2007-000309	C CAPACITOR	100nF 25V K
C433	T2901-HC011A	C CAPACITOR	100nF 25V K	C623	2007-000119	C CAPACITOR	3.9nF 50V K
C434	T2901-HC011A	C CAPACITOR	100nF 25V K	C624	2007-000119	C CAPACITOR	3.9nF 50V K
C435	T2901-HC011A	C CAPACITOR	100nF 25V K	C625	T0507-00005A	C CAPACITOR	1nF 50V K
C436	T1001-00051A	C CAPACITOR	10pF 50V K	C626	2007-000076	C CAPACITOR	0.33nF 50V K
C438	T2901-HC011A	C CAPACITOR	100nF 25V K	C627	2007-000076	C CAPACITOR	0.33nF 50V K
C439	T2901-JC005A	C CAPACITOR	100nF 25V K	C632	2007-000076	C CAPACITOR	0.33nF 50V K
C440	T2901-JC005A	C CAPACITOR	100nF 25V K	C633	2007-000076	C CAPACITOR	0.33nF 50V K
C441	T2901-JC005A	C CAPACITOR	100nF 25V K	C634	2007-001134	C CAPACITOR	1uF 16V Z
C442	T2901-JC005A	C CAPACITOR	100nF 25V K	C635	2007-001134	C CAPACITOR	1uF 16V Z
C443	T2901-JC005A	C CAPACITOR	100nF 25V K	C636	T0507-00006A	C CAPACITOR	47pF 50V K
C444	T2901-JC012B	C CAPACITOR	100nF 25V K	C638	2007-000309	C CAPACITOR	100nF 25V K
C445	T2901-JC012B	C CAPACITOR	100nF 25V K	C639	2007-000090	C CAPACITOR	6.8nF 50V K
C446	T2901-JC012B	C CAPACITOR	100nF 25V K	C640	2007-000090	C CAPACITOR	6.8nF 50V K
C447	T2901-JC012B	C CAPACITOR	100nF 25V K	C701	2007-000071	C CAPACITOR	100nF 25V K
C451	T0507-00002A	C CAPACITOR	10nF 50V K	C702	2007-000071	C CAPACITOR	100nF 25V K
C452	T2901-JC012B	C CAPACITOR	100nF 25V K	C703	T0507-00008A	C CAPACITOR	10nF 50V K
C453	T2901-JC010B	C CAPACITOR	100nF 25V K	C707	2007-000072	C CAPACITOR	100nF 50V K
C454	T2901-JC010B	C CAPACITOR	100nF 25V K	C710	2007-000084	C CAPACITOR	47nF 50V K
C455	2007-000078	C CAPACITOR	0.47nF 50V K	C712	2007-001167	C CAPACITOR	0.15nF 50V K
C456	T2901-JC010B	C CAPACITOR	100nF 25V K	C714	2007-000402	C CAPACITOR	2.2nF 50V K
C457	T2901-JC010B	C CAPACITOR	100nF 25V K	C715	T0507-00005A	C CAPACITOR	1nF 50V K
C458	T2901-JC010B	C CAPACITOR	100nF 25V K	C801	2007-000071	C CAPACITOR	100nF 25V K
C459	2007-001167	C CAPACITOR	0.15nF 50V K	C802	2007-000071	C CAPACITOR	100nF 25V K
C460	2007-001167	C CAPACITOR	0.15nF 50V K	C805	2007-000071	C CAPACITOR	100nF 25V K
C461	2007-000115	C CAPACITOR	1.5nF 50V K	C806	2007-000113	C CAPACITOR	100nF 25V K
C501	T2901-JC004A	C CAPACITOR	100nF 25V K	C807	2007-000113	C CAPACITOR	100nF 25V K
C502	T2901-JC004A	C CAPACITOR	100nF 25V K	C820	2007-000113	C CAPACITOR	100nF 25V K
C503	T2901-JC004A	C CAPACITOR	100nF 25V K	C821	2007-000113	C CAPACITOR	100nF 25V K
C504	T2901-JC004A	C CAPACITOR	100nF 25V K	C2251	2007-000113	C CAPACITOR	100nF 25V K
C506	T2901-JC004A	C CAPACITOR	100nF 25V K	CA02	T0507-00006A	C CAPACITOR	47pF 50V K
C507	T2703-KC007A	C CAPACITOR	100nF 25V K	CA03	T0507-00006A	C CAPACITOR	47pF 50V K
C508	T2703-KC007A	C CAPACITOR	100nF 25V K	L301	T3711-00037	C RESISTOR	4.7KΩ 1/16W J
C509	T2703-KC007A	C CAPACITOR	100nF 25V K	R101	2401-001363	C RESISTOR	330Ω 1/16W J
C510	T2703-KC007A	C CAPACITOR	100nF 25V K	R102	2401-001363	C RESISTOR	330Ω 1/16W J
C511	T2703-KC007A	C CAPACITOR	100nF 25V K	R104	2401-001363	C RESISTOR	330Ω 1/16W J
C512	T2703-KC014A	C CAPACITOR	100nF 25V K	R107	T2401-BT101O	C RESISTOR	220Ω 1/16W J
C513	T2703-KC014A	C CAPACITOR	100nF 25V K	R108	T2203-FC060D	C RESISTOR	0Ω 1/16W J
C514	T2703-KC014A	C CAPACITOR	100nF 25V K	R109	T1001-00087A	C RESISTOR	100KΩ 1/16W J
C515	T2703-KC014A	C CAPACITOR	100nF 25V K	R110	T1001-00087A	C RESISTOR	100KΩ 1/16W J
C516	T2703-KC014A	C CAPACITOR	100nF 25V K	R114	T1001-00087A	C RESISTOR	100KΩ 1/16W J
C517	T2703-LC010A	C CAPACITOR	100nF 25V K	R115	2401-001363	C RESISTOR	330Ω 1/16W J
C518	T2703-LC010A	C CAPACITOR	100nF 25V K	R119	2401-001363	C RESISTOR	330Ω 1/16W J
C519	T2703-LC010A	C CAPACITOR	100nF 25V K	R121	T1001-00087A	C RESISTOR	100KΩ 1/16W J
C520	T2703-LC010A	C CAPACITOR	100nF 25V K	R123	T2401-CT471O	C RESISTOR	330Ω 1/16W J
C524	T2703-LC010A	C CAPACITOR	100nF 25V K	R124	T2401-BT101O	C RESISTOR	220Ω 1/16W J
C525	T2703-IC002A	C CAPACITOR	100nF 25V K	R126	TA40-00016A	C RESISTOR	1KΩ 1/16W J
C526	T2703-IC002A	C CAPACITOR	100nF 25V K	R127	T1001-00073A	C RESISTOR	10KΩ 1/16W J
C527	T2703-IC002A	C CAPACITOR	100nF 25V K				

△Ref No.	Part No.	Part Name	Description Local	△Ref No.	Part No.	Part Name	Description Local
R128	T1001-00073A	C RESISTOR	10KΩ 1/16W J	R331	T2401-CT4700	C RESISTOR	100Ω 1/16W J
R129	T1001-00073A	C RESISTOR	10KΩ 1/16W J	R332	T2203-DC104E	C RESISTOR	22Ω 1/16W J
R130	TA40-00016A	C RESISTOR	1KΩ 1/16W J	R333	T2203-DC104E	C RESISTOR	22Ω 1/16W J
R131	T3711-00034	C RESISTOR	1.5KΩ 1/16W J	R335	T1001-00084A	C RESISTOR	22KΩ 1/16W J
R132	T1001-00086A	C RESISTOR	47KΩ 1/16W J	R336	T1001-00086A	C RESISTOR	47KΩ 1/16W J
R133	T2401-BT1010	C RESISTOR	220Ω 1/16W J	R337	T3711-00036	C RESISTOR	3.3KΩ 1/16W J
R134	T1001-00073A	C RESISTOR	10KΩ 1/16W J	R338	T3711-00036	C RESISTOR	3.3KΩ 1/16W J
R136	T1001-00085A	C RESISTOR	27KΩ 1/16W J	R339	T3711-00036	C RESISTOR	3.3KΩ 1/16W J
R138	T1001-00073A	C RESISTOR	10KΩ 1/16W J	R340	T2203-DC104E	C RESISTOR	22Ω 1/16W J
R210	2401-002075	C RESISTOR	270Ω 1/16W J	R341	T2401-CT4700	C RESISTOR	100Ω 1/16W J
R211	T2401-FT0R1A	C RESISTOR	100Ω 1/16W J	R342	T2203-FC101D	C RESISTOR	10Ω 1/16W J
R214	TA40-00016A	C RESISTOR	1KΩ 1/16W J	R343	T3722-00040A	C RESISTOR	1KΩ 1/16W J
R215	TA40-00016A	C RESISTOR	1KΩ 1/16W J	R344	T2401-CT4700	C RESISTOR	100Ω 1/16W J
R216	TA40-00016A	C RESISTOR	1KΩ 1/16W J	R345	T2401-CT4700	C RESISTOR	100Ω 1/16W J
R217	T3722-00054A	C RESISTOR	1KΩ 1/16W J	R346	2401-000914	C RESISTOR	100Ω 1/16W J
R218	T3722-00054A	C RESISTOR	1KΩ 1/16W J	R347	2401-000914	C RESISTOR	100Ω 1/16W J
R219	T3722-00054A	C RESISTOR	1KΩ 1/16W J	R348	2401-000914	C RESISTOR	100Ω 1/16W J
R220	T3722-00054A	C RESISTOR	1KΩ 1/16W J	R349	T3711-00037	C RESISTOR	4.7KΩ 1/16W J
R223	T2801-00011A	C RESISTOR	470Ω 1/16W J	R350	T3711-00037	C RESISTOR	4.7KΩ 1/16W J
R224	T2203-FC152D	C RESISTOR	33Ω 1/16W J	R351	T2203-FC221E	C RESISTOR	33Ω 1/16W J
R225	T2203-FC392D	C RESISTOR	75Ω 1/16W J	R352	T2203-FC221E	C RESISTOR	33Ω 1/16W J
R226	T2203-FC152D	C RESISTOR	33Ω 1/16W J	R353	T2203-FC221E	C RESISTOR	33Ω 1/16W J
R227	T2203-FC392D	C RESISTOR	75Ω 1/16W J	R354	T2203-FC222D	C RESISTOR	33Ω 1/16W J
R228	T2203-FC152D	C RESISTOR	33Ω 1/16W J	R355	2401-000914	C RESISTOR	100Ω 1/16W J
R229	T2203-FC392D	C RESISTOR	75Ω 1/16W J	R356	2401-000914	C RESISTOR	100Ω 1/16W J
R230	T2203-FC152D	C RESISTOR	33Ω 1/16W J	R357	T3711-00036	C RESISTOR	3.3KΩ 1/16W J
R231	T2203-FC152D	C RESISTOR	33Ω 1/16W J	R358	2401-000603	C RESISTOR	100Ω 1/16W J
R232	T2801-00011A	C RESISTOR	470Ω 1/16W J	R359	2401-000603	C RESISTOR	100Ω 1/16W J
R233	T2203-FC221E	C RESISTOR	33Ω 1/16W J	R360	T3711-00036	C RESISTOR	3.3KΩ 1/16W J
R235	T2203-FC392D	C RESISTOR	75Ω 1/16W J	R361	T3711-00019	C RESISTOR	4.7KΩ 1/16W J
R236	T2203-FC392D	C RESISTOR	75Ω 1/16W J	R363	T2801-00014A	C RESISTOR	680Ω 1/16W J
R237	T2203-FC104E	C RESISTOR	82Ω 1/16W J	R364	T2203-FC102D	C RESISTOR	10Ω 1/16W J
R238	T2203-FC104E	C RESISTOR	82Ω 1/16W J	R365	T3711-00019	C RESISTOR	4.7KΩ 1/16W J
R239	T2203-FC104E	C RESISTOR	82Ω 1/16W J	R367	2401-000603	C RESISTOR	100Ω 1/16W J
R242	T2203-FC471D	C RESISTOR	75Ω 1/16W J	R370	T1001-00064A	C RESISTOR	10KΩ 1/16W J
R243	T3722-00054A	C RESISTOR	1KΩ 1/16W J	R371	T2401-CT4710	C RESISTOR	330Ω 1/16W J
R244	T3722-00040A	C RESISTOR	1KΩ 1/16W J	R373	2401-000603	C RESISTOR	100Ω 1/16W J
R245	T2203-FC471D	C RESISTOR	75Ω 1/16W J	R375	T1001-00064A	C RESISTOR	10KΩ 1/16W J
R246	T2203-FC471D	C RESISTOR	75Ω 1/16W J	R376	2401-002075	C RESISTOR	270Ω 1/16W J
R247	T2203-FC471D	C RESISTOR	75Ω 1/16W J	R377	T2203-FC060D	C RESISTOR	0Ω 1/16W J
R248	T1001-00064A	C RESISTOR	10KΩ 1/16W J	R378	T3722-00040A	C RESISTOR	1KΩ 1/16W J
R249	T1001-00064A	C RESISTOR	10KΩ 1/16W J	R380	T1001-00083A	C RESISTOR	10KΩ 1/16W J
R255	T2401-FT0R1A	C RESISTOR	100Ω 1/16W J	R382	2401-000603	C RESISTOR	100Ω 1/16W J
R256	T2203-FC471D	C RESISTOR	75Ω 1/16W J	R383	T2801-00013A	C RESISTOR	560Ω 1/16W J
R260	T2203-FC472D	C RESISTOR	75Ω 1/16W J	R385	2401-002235	C RESISTOR	100Ω 1/16W J
R261	T1001-00085A	C RESISTOR	27KΩ 1/16W J	R390	T3711-00019	C RESISTOR	4.7KΩ 1/16W J
R262	T2203-FC472D	C RESISTOR	75Ω 1/16W J	R391	T2203-FC060D	C RESISTOR	0Ω 1/16W J
R263	T2203-FC472D	C RESISTOR	75Ω 1/16W J	R392	T3711-00019	C RESISTOR	4.7KΩ 1/16W J
R264	T2203-FC472D	C RESISTOR	75Ω 1/16W J	R393	2401-002235	C RESISTOR	100Ω 1/16W J
R267	T2203-FC472D	C RESISTOR	75Ω 1/16W J	R394	T3722-00040A	C RESISTOR	1KΩ 1/16W J
R271	T2401-FT0R1A	C RESISTOR	100Ω 1/16W J	R395	T2203-FC330D	C RESISTOR	0Ω 1/16W J
R272	T2401-FT0R1A	C RESISTOR	100Ω 1/16W J	R396	T3711-00029	C RESISTOR	3.3KΩ 1/16W J
R273	2401-002075	C RESISTOR	270Ω 1/16W J	R397	T3711-00029	C RESISTOR	3.3KΩ 1/16W J
R274	T2401-FT0R1A	C RESISTOR	100Ω 1/16W J	R411	T2801-00011A	C RESISTOR	470Ω 1/16W J
R275	T2203-FC060D	C RESISTOR	0Ω 1/16W J	R412	T2203-FC334D	C RESISTOR	68Ω 1/16W J
R277	T2203-FC060D	C RESISTOR	0Ω 1/16W J	R413	2401-002235	C RESISTOR	100Ω 1/16W J
R278	T3722-00040A	C RESISTOR	1KΩ 1/16W J	R414	T2203-FC222D	C RESISTOR	33Ω 1/16W J
R279	T3722-00040A	C RESISTOR	1KΩ 1/16W J	R415	T2801-00014A	C RESISTOR	680Ω 1/16W J
R280	T3722-00040A	C RESISTOR	1KΩ 1/16W J	R416	T2203-DC104E	C RESISTOR	22Ω 1/16W J
R281	T2203-FC104E	C RESISTOR	82Ω 1/16W J	R417	T2203-DC104E	C RESISTOR	22Ω 1/16W J
R282	T2203-FC104E	C RESISTOR	82Ω 1/16W J	R418	T3711-00019	C RESISTOR	4.7KΩ 1/16W J
R283	T2203-BC106E	C RESISTOR	82Ω 1/16W J	R419	T2203-FC100D	C RESISTOR	0Ω 1/16W J
R285	T2203-FC473D	C RESISTOR	75Ω 1/16W J	R427	T1001-00052A	C RESISTOR	1MΩ 1/16W J
R286	T1001-00085A	C RESISTOR	27KΩ 1/16W J	R429	T2203-FC222D	C RESISTOR	33Ω 1/16W J
R287	T2203-FC470D	C RESISTOR	4.7Ω 1/16W J	R432	T2203-FC222D	C RESISTOR	33Ω 1/16W J
R288	T2203-FC473D	C RESISTOR	75Ω 1/16W J	R434	T2203-FC222D	C RESISTOR	33Ω 1/16W J
R289	T2203-FC473D	C RESISTOR	75Ω 1/16W J	R436	T2203-FC224D	C RESISTOR	33Ω 1/16W J
R290	2401-000269	C RESISTOR	100Ω 1/16W J	R442	T2203-FC331D	C RESISTOR	33Ω 1/16W J
R291	2401-000269	C RESISTOR	100Ω 1/16W J	R456	T3711-00038	C RESISTOR	4.7KΩ 1/16W J
R292	T3722-00040A	C RESISTOR	1KΩ 1/16W J	R457	T2203-FC682D	C RESISTOR	75Ω 1/16W J
R294	T2203-FC470D	C RESISTOR	4.7Ω 1/16W J	R458	T2203-FC682D	C RESISTOR	75Ω 1/16W J
R295	T2203-FC473D	C RESISTOR	75Ω 1/16W J	R459	T2203-FC682D	C RESISTOR	75Ω 1/16W J
R296	T3722-00040A	C RESISTOR	1KΩ 1/16W J	R460	T3711-00038	C RESISTOR	4.7KΩ 1/16W J
R299	T2203-FC221E	C RESISTOR	33Ω 1/16W J	R461	T1001-00070A	C RESISTOR	470KΩ 1/16W J
R304	2401-000269	C RESISTOR	100Ω 1/16W J	R462	T3711-00038	C RESISTOR	4.7KΩ 1/16W J
R305	2401-000269	C RESISTOR	100Ω 1/16W J	R501	T1001-00083A	C RESISTOR	10KΩ 1/16W J
R307	2401-000269	C RESISTOR	100Ω 1/16W J	R504	T3711-00038	C RESISTOR	4.7KΩ 1/16W J
R308	2401-001495	C RESISTOR	100Ω 1/16W J	R505	T1001-00087A	C RESISTOR	100KΩ 1/16W J
R310	T1001-00064A	C RESISTOR	10KΩ 1/16W J	R509	2007-001167	CHIP BEAD	30Ω
R313	2401-001495	C RESISTOR	100Ω 1/16W J	R510	2007-001167	CHIP BEAD	30Ω
R314	T3711-00037	C RESISTOR	4.7KΩ 1/16W J	R511	2007-001167	CHIP BEAD	30Ω
R315	T2203-FC101D	C RESISTOR	10Ω 1/16W J	R515	2007-001167	CHIP BEAD	30Ω
R316	T2203-FC101D	C RESISTOR	10Ω 1/16W J	R516	2007-001167	CHIP BEAD	30Ω
R317	T2203-FC101D	C RESISTOR	10Ω 1/16W J	R517	2007-000115	CHIP BEAD	30Ω
R318	T3711-00035	C RESISTOR	2.7KΩ 1/16W J	R518	2007-000115	CHIP BEAD	30Ω
R319	T2203-FC101D	C RESISTOR	10Ω 1/16W J	R519	2007-000115	CHIP BEAD	30Ω
R320	2401-001495	C RESISTOR	100Ω 1/16W J	R529	T2203-FC100D	C RESISTOR	0Ω 1/16W J
R321	T3711-00035	C RESISTOR	2.7KΩ 1/16W J	R540	T2203-FC102D	C RESISTOR	10Ω 1/16W J
R322	2401-001495	C RESISTOR	100Ω 1/16W J	R541	2007-000115	CHIP BEAD	30Ω
R327	2401-001495	C RESISTOR	100Ω 1/16W J	R542	2007-000115	CHIP BEAD	30Ω
R328	T2401-CT4700	C RESISTOR	100Ω 1/16W J	R543	2007-000074	CHIP BEAD	30Ω
R329	T2203-FC473D	C RESISTOR	75Ω 1/16W J	R544	T2203-FC104D	C RESISTOR	22Ω 1/16W J
R330	T3711-00037	C RESISTOR	4.7KΩ 1/16W J	R546	2007-000074	CHIP BEAD	30Ω

△Ref No.	Part No.	Part Name	Description	Local	△Ref No.	Part No.	Part Name	Description	Local
R548	2007-000074	CHIP BEAD		30Ω	R2291	AA60-40014A	C RESISTOR	4.7KΩ	1/16W J
R550	2007-000074	CHIP BEAD		30Ω	R2292	AA60-40014A	C RESISTOR	4.7KΩ	1/16W J
R560	2007-000074	CHIP BEAD		30Ω	R2293	T1001-00081A	C RESISTOR	4.7KΩ	1/16W J
R561	2007-000402	CHIP BEAD		30Ω	RA01	T2203-FC220D	C RESISTOR	0Ω	1/16W J
R562	2007-000402	CHIP BEAD		30Ω	RA02	T2203-FC330D	C RESISTOR	0Ω	1/16W J
R563	2007-000402	CHIP BEAD		30Ω	RA03	T2203-FC331D	C RESISTOR	33Ω	1/16W J
R565	2007-000402	CHIP BEAD		30Ω	RA04	T2203-FC224D	C RESISTOR	33Ω	1/16W J
R566	T2203-FC102D	C RESISTOR	10Ω	1/16W J	RA05	T2203-FC224D	C RESISTOR	33Ω	1/16W J
R567	2007-000402	CHIP BEAD		30Ω	RA06	T2203-FC224D	C RESISTOR	33Ω	1/16W J
R568	T2203-FC102D	C RESISTOR	10Ω	1/16W J	RA07	T2203-FC224D	C RESISTOR	33Ω	1/16W J
R571	T2203-FC334D	C RESISTOR	68Ω	1/16W J	RA08	T2203-FC331D	C RESISTOR	33Ω	1/16W J
R572	T2203-FC334D	C RESISTOR	68Ω	1/16W J	RA09	T2203-FC331D	C RESISTOR	33Ω	1/16W J
R573	T2203-FC334D	C RESISTOR	68Ω	1/16W J	RA10	T2203-FC331D	C RESISTOR	33Ω	1/16W J
R574	2401-002235	C RESISTOR	100Ω	1/16W J					
R575	T2203-FC334D	C RESISTOR	68Ω	1/16W J	L201	2007-000309	CHIP BEAD		80Ω
R577	2007-000075	CHIP BEAD		30Ω	L202	2007-000309	CHIP BEAD		80Ω
R579	2007-000075	CHIP BEAD		30Ω	L203	2007-000309	CHIP BEAD		80Ω
R582	2007-000075	CHIP BEAD		30Ω	L204	2007-000309	CHIP BEAD		80Ω
R583	2007-000075	CHIP BEAD		30Ω	L205	2007-000309	CHIP BEAD		80Ω
R584	2007-000075	CHIP BEAD		30Ω	L206	2007-000071	CHIP BEAD		80Ω
R585	2007-000643	CHIP BEAD		30Ω	L207	2007-000071	CHIP BEAD		80Ω
R586	2007-000643	CHIP BEAD		30Ω	L208	2007-000071	CHIP BEAD		80Ω
R587	2007-000643	CHIP BEAD		30Ω	L209	2007-000071	CHIP BEAD		80Ω
R588	2007-000643	CHIP BEAD		30Ω	L210	2007-000071	CHIP BEAD		80Ω
R589	T2203-FC220D	C RESISTOR	0Ω	1/16W J	L211	2007-000113	CHIP BEAD		80Ω
R591	2007-000643	CHIP BEAD		30Ω	L214	2007-000113	CHIP BEAD		80Ω
R592	2007-000076	CHIP BEAD		30Ω	L215	2007-000113	CHIP BEAD		80Ω
R593	T3722-00040A	C RESISTOR	1KΩ	1/16W J	L216	2007-000113	CHIP BEAD		80Ω
R594	T3722-00041A	C RESISTOR	1KΩ	1/16W J	L217	2007-000113	CHIP BEAD		80Ω
R595	T3711-00038	C RESISTOR	4.7KΩ	1/16W J	L218	2007-000072	CHIP BEAD		80Ω
R596	T3711-00037	C RESISTOR	4.7KΩ	1/16W J	L219	2007-000072	CHIP BEAD		80Ω
R597	T2401-BT102A	C RESISTOR	390Ω	1/16W J	L220	2007-000072	CHIP BEAD		80Ω
R601	T3722-00041A	C RESISTOR	1KΩ	1/16W J	L221	2007-000072	CHIP BEAD		80Ω
R602	T1001-00063A	C RESISTOR	68KΩ	1/16W J	L302	2007-000072	CHIP BEAD		80Ω
R603	2401-000242	C RESISTOR	150Ω	1/16W J	L303	2007-001134	CHIP BEAD		80Ω
R604	T3711-00037	C RESISTOR	4.7KΩ	1/16W J	L304	2007-001134	CHIP BEAD		80Ω
R605	T3722-00041A	C RESISTOR	1KΩ	1/16W J	L305	2007-001134	CHIP BEAD		80Ω
R606	T1001-00086A	C RESISTOR	47KΩ	1/16W J	L306	2007-000093	CHIP BEAD		500Ω
R607	T3711-00037	C RESISTOR	4.7KΩ	1/16W J	L317	T2007-HC330J	CHIP COIL		10uH
R608	T1001-00075A	C RESISTOR	30KΩ	1/16W J	L401	2007-000093	CHIP BEAD		500Ω
R609	T3722-00041A	C RESISTOR	1KΩ	1/16W J	L402	2007-000093	CHIP BEAD		500Ω
R610	T1001-00075A	C RESISTOR	30KΩ	1/16W J	L404	2007-000093	CHIP BEAD		500Ω
R611	T3722-00041A	C RESISTOR	1KΩ	1/16W J	L405	2007-000093	CHIP BEAD		500Ω
R612	T1001-00086A	C RESISTOR	47KΩ	1/16W J	L406	2007-000094	CHIP BEAD		500Ω
R613	2401-002235	C RESISTOR	100Ω	1/16W J	L408	2007-000094	CHIP BEAD		500Ω
R614	2401-002594	C RESISTOR	100Ω	1/16W J	L501	2007-000094	CHIP BEAD		500Ω
R615	2401-002594	C RESISTOR	100Ω	1/16W J	L502	2007-000094	CHIP BEAD		500Ω
R616	2401-002594	C RESISTOR	100Ω	1/16W J	L504	2007-000094	CHIP BEAD		500Ω
R617	2401-002594	C RESISTOR	100Ω	1/16W J	L505	2007-000129	CHIP BEAD		500Ω
R618	2401-002594	C RESISTOR	100Ω	1/16W J	L507	2007-000129	CHIP BEAD		500Ω
R619	T2203-FC100D	C RESISTOR	0Ω	1/16W J	L509	2007-000129	CHIP BEAD		500Ω
R620	T2203-FC100D	C RESISTOR	0Ω	1/16W J	L510	2007-000129	CHIP BEAD		500Ω
R621	T2203-FC220D	C RESISTOR	0Ω	1/16W J	L511	2007-000129	CHIP BEAD		500Ω
R622	T2203-FC220D	C RESISTOR	0Ω	1/16W J	L512	2007-000096	CHIP BEAD		500Ω
R623	T1001-00083A	C RESISTOR	10KΩ	1/16W J	L513	2007-000096	CHIP BEAD		500Ω
R624	T1001-00082A	C RESISTOR	20KΩ	1/16W J	L514	2007-000096	CHIP BEAD		500Ω
R625	T3711-00033	C RESISTOR	1KΩ	1/16W J	L515	2007-000096	CHIP BEAD		500Ω
R629	T2401-CT221O	C RESISTOR	100Ω	1/16W J	L516	2007-000096	CHIP BEAD		500Ω
R630	T1001-00082A	C RESISTOR	20KΩ	1/16W J	L517	2007-000097	CHIP BEAD		500Ω
R631	T1001-00083A	C RESISTOR	10KΩ	1/16W J	L5VA	2007-000120	CHIP BEAD		80Ω
R632	T2203-FC102D	C RESISTOR	10Ω	1/16W J	L5VB	2007-000120	CHIP BEAD		80Ω
R633	T3711-00037	C RESISTOR	4.7KΩ	1/16W J	L5VC	2007-000121	CHIP BEAD		80Ω
R701	T2401-CT221O	C RESISTOR	100Ω	1/16W J	L601	T2007-HC472J	CHIP COIL		10uH
R702	T2401-CT221O	C RESISTOR	100Ω	1/16W J	L602	T2007-HC472J	CHIP COIL		10uH
R703	T2401-CT221O	C RESISTOR	100Ω	1/16W J	L603	2007-000097	CHIP BEAD		500Ω
R704	T2801-00013A	C RESISTOR	560Ω	1/16W J	L606	2007-000097	CHIP BEAD		500Ω
R705	T2801-00012A	C RESISTOR	820Ω	1/16W J	L608	2007-000097	CHIP BEAD		500Ω
R707	T2203-FC103D	C RESISTOR	10Ω	1/16W J	L610	2007-000121	CHIP BEAD		80Ω
R708	T2401-CT221O	C RESISTOR	100Ω	1/16W J	L701	2007-000109	CHIP COIL		10uH
R709	T2203-FC103D	C RESISTOR	10Ω	1/16W J	L703	2007-000102	SMD COIL		680uH
R710	T3711-00033	C RESISTOR	1KΩ	1/16W J	L705	2007-000100	SMD COIL		470uH
R711	T2203-FC330D	C RESISTOR	0Ω	1/16W J	L801	2007-000118	CHIP BEAD		80Ω
R712	T1001-00088A	C RESISTOR	100KΩ	1/16W J	L802	2007-000118	CHIP BEAD		80Ω
R713	T1001-00084A	C RESISTOR	22KΩ	1/16W J	L803	2007-000118	CHIP BEAD		80Ω
R801	T1001-00083A	C RESISTOR	10KΩ	1/16W J	L804	2007-000118	CHIP BEAD		80Ω
R802	T3711-00037	C RESISTOR	4.7KΩ	1/16W J	L805	2007-000118	CHIP BEAD		80Ω
R803	2401-002075	C RESISTOR	270Ω	1/16W J	L806	2007-000077	CHIP BEAD		80Ω
R804	AA60-40014A	C RESISTOR	4.7KΩ	1/16W J	L807	2007-000077	CHIP BEAD		80Ω
R805	AA60-40014A	C RESISTOR	4.7KΩ	1/16W J	L808	2007-000077	CHIP BEAD		80Ω
R806	AA60-40014A	C RESISTOR	4.7KΩ	1/16W J	L809	2007-000077	CHIP BEAD		80Ω
R810	T2203-FC220D	C RESISTOR	0Ω	1/16W J	L810	2007-000077	CHIP BEAD		80Ω
R2215	T2203-FC332D	C RESISTOR	47Ω	1/16W J	L812	2007-000119	CHIP BEAD		80Ω
R2219	T2203-FC104D	C RESISTOR	22Ω	1/16W J	L813	2007-000119	CHIP BEAD		80Ω
R2220	T2203-FC104D	C RESISTOR	22Ω	1/16W J	L814	2007-000107	SMD COIL		100uH
R2221	T2203-FC104D	C RESISTOR	22Ω	1/16W J	L815	2007-000119	CHIP BEAD		80Ω
R2222	T2203-FC104D	C RESISTOR	22Ω	1/16W J	L816	2007-000119	CHIP BEAD		80Ω
R2223	T2203-CC105D	C RESISTOR	22Ω	1/16W J	L820	2007-000119	CHIP BEAD		80Ω
R2224	T2203-CC105D	C RESISTOR	22Ω	1/16W J	L821	2007-000120	CHIP BEAD		80Ω
R2225	T2203-CC105D	C RESISTOR	22Ω	1/16W J	L822	2007-000120	CHIP BEAD		80Ω
R2226	T2203-CC105D	C RESISTOR	22Ω	1/16W J	L823	2007-000120	CHIP BEAD		80Ω
R2227	T2203-CC105D	C RESISTOR	22Ω	1/16W J	L830	T3711-00033	C RESISTOR		1KΩ 1/16W J
R2228	T2203-FC150D	C RESISTOR	22Ω	1/16W J	LA01	2007-000121	CHIP BEAD		80Ω
R2290	T3711-00033	C RESISTOR	1KΩ	1/16W J	LA02	2007-000121	CHIP BEAD		80Ω

△Ref No.	Part No.	Part Name	Description	Local	△Ref No.	Part No.	Part Name	Description	Local
CE101	2007-000097	E CAPACITOR	100uF	16V M	J501	2401-000603	CONNECTOR		
CE102	2007-000107	E CAPACITOR	47uF	16V M	J601	T2401-CT4700	CONNECTOR		
CE103	2007-000109	E CAPACITOR	22uF	16V M	J602	2401-000914	CONNECTOR		
CE105	T2203-FC220D	E CAPACITOR	10uF	16V M	J801	2401-002235	CONNECTOR		
CE107	T2203-FC060D	E CAPACITOR	1uF	50V M	RN301	2007-000084	BEAD ARRAY	120Ω	
CE108	2007-000096	E CAPACITOR	0.1uF	50V M	RN302	2007-000084	BEAD ARRAY	120Ω	
CE202	T2203-FC220D	E CAPACITOR	10uF	16V M	RN303	2007-000084	BEAD ARRAY	120Ω	
CE203	T2203-FC220D	E CAPACITOR	10uF	16V M	RN304	2007-000084	BEAD ARRAY	120Ω	
CE204	T2203-FC220D	E CAPACITOR	10uF	16V M	RN305	2007-000084	BEAD ARRAY	120Ω	
CE205	T2203-FC220D	E CAPACITOR	10uF	16V M	RN306	2007-000090	BEAD ARRAY	120Ω	
CE206	T2203-FC103D	E CAPACITOR	220uF	16V M	RN307	2007-000090	BEAD ARRAY	120Ω	
CE207	T2203-FC103D	E CAPACITOR	220uF	16V M	RN308	T1001-00079A	CHIP ARRAY	4.7KΩ	1/16W J
CE220	2007-000097	E CAPACITOR	100uF	16V M	RN309	2007-000090	BEAD ARRAY	120Ω	
CE221	2007-000097	E CAPACITOR	100uF	16V M	RN310	T1001-00079A	CHIP ARRAY	4.7KΩ	1/16W J
CE301	T2203-FC150D	E CAPACITOR	100uF	10V M	RN408	2007-000078	BEAD ARRAY	30Ω	
CE302	T2203-CC105D	E CAPACITOR	100uF	10V M	RN409	2007-000078	BEAD ARRAY	30Ω	
CE402	2007-000109	E CAPACITOR	22uF	16V M	RN410	2007-000078	BEAD ARRAY	30Ω	
CE404	T2203-FC330D	E CAPACITOR	10uF	16V M	RN411	2007-000078	BEAD ARRAY	30Ω	
CE405	T2203-FC330D	E CAPACITOR	10uF	16V M	RN412	T1001-00049A	CHIP ARRAY	33Ω	1/16W J
CE407	T2203-FC330D	E CAPACITOR	10uF	16V M	RN413	T1001-00049A	CHIP ARRAY	33Ω	1/16W J
CE408	T2203-FC330D	E CAPACITOR	10uF	16V M	RN414	T1001-00049A	CHIP ARRAY	33Ω	1/16W J
CE410	T2203-FC221E	E CAPACITOR	470uF	16V M	RN415	T1001-00049A	CHIP ARRAY	33Ω	1/16W J
CE411	T2203-FC152D	E CAPACITOR	4.7uF	50V M	RN416	T1001-00049A	CHIP ARRAY	33Ω	1/16W J
CE412	T2203-FC330D	E CAPACITOR	10uF	16V M	RN417	T1001-00078A	CHIP ARRAY	33Ω	1/16W J
CE413	T2203-FC470D	E CAPACITOR	10uF	16V M	RN418	T1001-00078A	CHIP ARRAY	33Ω	1/16W J
CE414	T2203-FC152D	E CAPACITOR	4.7uF	50V M	RN503	2007-000081	BEAD ARRAY	30Ω	
CE415	T2203-FC470D	E CAPACITOR	10uF	16V M	RN505	2007-000081	BEAD ARRAY	30Ω	
CE416	T2203-FC152D	E CAPACITOR	4.7uF	50V M	RN508	2007-000081	BEAD ARRAY	30Ω	
CE502	T2203-FC104D	E CAPACITOR	220uF	16V M	RN509	2007-000081	BEAD ARRAY	30Ω	
CE503	2007-000097	E CAPACITOR	100uF	16V M	RN510	2007-000082	BEAD ARRAY	30Ω	
CE504	2007-000107	E CAPACITOR	47uF	16V M	RN511	2007-000082	BEAD ARRAY	30Ω	
CE506	2007-000109	E CAPACITOR	22uF	16V M	RN512	2007-000082	BEAD ARRAY	30Ω	
CE507	2007-000109	E CAPACITOR	22uF	16V M	RN513	2007-000078	BEAD ARRAY	30Ω	
CE508	2007-000102	E CAPACITOR	47uF	16V M	RN514	2007-000082	BEAD ARRAY	30Ω	
CE509	2007-000109	E CAPACITOR	22uF	16V M	RN515	2007-000123	BEAD ARRAY	30Ω	
CE510	T2007-HC330J	E CAPACITOR	22uF	16V M	RN516	2007-000123	BEAD ARRAY	30Ω	
CE511	T2007-HC330J	E CAPACITOR	22uF	16V M	RN517	2007-000123	BEAD ARRAY	30Ω	
CE512	T2007-HC330J	E CAPACITOR	22uF	16V M	RN518	2007-000123	BEAD ARRAY	30Ω	
CE513	T2007-HC330J	E CAPACITOR	22uF	16V M	RN519	2007-000123	BEAD ARRAY	30Ω	
CE514	T2007-HC330J	E CAPACITOR	22uF	16V M	RN520	2007-000081	BEAD ARRAY	30Ω	
CE515	T2007-HC472J	E CAPACITOR	22uF	16V M	X301	T2203-FC331D	CRYSTAL	6MHz	
CE516	T2007-HC472J	E CAPACITOR	22uF	16V M	X401	T2203-FC392D	CRYSTAL	27MHz	
CE517	T2203-FC470D	E CAPACITOR	10uF	16V M	X501	T2203-FC332D	CRYSTAL	14.318MHz	
CE518	2007-000097	E CAPACITOR	100uF	16V M	X601	T2203-FC334D	CRYSTAL	18.432MHz	
CE601	T2203-FC103D	E CAPACITOR	220uF	16V M					
CE602	T2203-FC103D	E CAPACITOR	220uF	16V M					
CE603	2007-000102	E CAPACITOR	47uF	16V M					
CE604	2007-000102	E CAPACITOR	47uF	16V M					
CE605	T2203-FC060D	E CAPACITOR	1uF	50V M					
CE606	T2203-CC105D	E CAPACITOR	100uF	10V M					
CE607	T2203-FC470D	E CAPACITOR	10uF	16V M					
CE608	T2203-FC470D	E CAPACITOR	10uF	16V M					
CE609	T2203-FC101D	E CAPACITOR	10uF	16V M					
CE610	T2203-FC101D	E CAPACITOR	10uF	16V M					
CE611	T2203-FC101D	E CAPACITOR	10uF	16V M					
CE612	2007-000102	E CAPACITOR	47uF	16V M					
CE613	T2203-FC101D	E CAPACITOR	10uF	16V M					
CE614	T2203-FC101D	E CAPACITOR	10uF	16V M					
CE617	T2203-FC102D	E CAPACITOR	10uF	16V M					
CE620	T2203-FC102D	E CAPACITOR	10uF	16V M					
CE621	T2203-FC102D	E CAPACITOR	10uF	16V M					
CE622	T2203-FC060D	E CAPACITOR	1uF	50V M					
CE623	T2203-FC060D	E CAPACITOR	1uF	50V M					
CE624	T2203-FC102D	E CAPACITOR	10uF	16V M					
CE625	T2203-FC060D	E CAPACITOR	1uF	50V M					
CE626	T2203-FC100D	E CAPACITOR	1uF	50V M					
CE627	2007-000102	E CAPACITOR	47uF	16V M					
CE630	T2007-HC472J	E CAPACITOR	22uF	16V M					
CE701	2007-000100	E CAPACITOR	100uF	16V M					
CE702	T2203-FC102D	E CAPACITOR	10uF	16V M					
CE703	2007-000100	E CAPACITOR	100uF	16V M					
CE704	2007-000100	E CAPACITOR	100uF	16V M					
CE705	T2203-FC100D	E CAPACITOR	1uF	50V M					
CE801	T2203-FC103D	E CAPACITOR	220uF	16V M					
CE802	T2203-FC221E	E CAPACITOR	470uF	16V M					
CE803	2007-000107	E CAPACITOR	47uF	16V M					
CE804	2007-000100	E CAPACITOR	100uF	16V M					
CE805	T2203-DC104E	E CAPACITOR	220uF	16V M					
CE808	T2203-FC104D	E CAPACITOR	220uF	16V M					
CE809	T2203-FC224D	E CAPACITOR	1000uF	10V M					
CE810	T2203-FC222D	E CAPACITOR	470uF	16V M					
CE811	T2203-DC104E	E CAPACITOR	220uF	16V M					
J101	2401-002594	CONNECTOR			D1	T0402-00012A	DIODE		
J102	T2401-CT221O	CONNECTOR			D2	T0402-00014A	DIODE		
J201	T2203-FC472D	JACK	PC IN		D4	T0407-00001A	DIODE		
J202	T2203-FC473D	JACK	EXT2		D5	T0407-00001A	DIODE		
J203	T2203-FC682D	JACK	EXT-1		D6	T0402-00013A	DIODE		
J205	T2203-FC104E	JACK	EXT-3/EXT4		D7	T0402-00013A	DIODE		
J209	T2401-FT0R1A	CONNECTOR			D8	T0402-00015A	DIODE		
J210	2401-000269	CONNECTOR			D9	T0402-00016A	DIODE		
J303	T2203-BC106E	CONNECTOR			D10	T0407-00001A	DIODE		
J304	2401-001495	CONNECTOR							

POWER P.W. BOARD ASS'Y (QAL0826-001)

△Ref No.	Part No.	Part Name	Description	Local
FB2	T2901-JC008A	FERRITE BEAD		
FB3	T2901-JC008A	FERRITE BEAD		
FB4	T2901-JC008A	FERRITE BEAD		
FB5	T2901-JC008A	FERRITE BEAD		
FB6	T2901-JC008A	FERRITE BEAD		
FB7	T2901-JC008A	FERRITE BEAD		
FB8	T2901-JC008A	FERRITE BEAD		
FB9	T2901-JC009A	FERRITE BEAD		
Q1	T0507-00009A	TRANSISTOR		
Q2	T0507-00009A	TRANSISTOR		
Q3	T0507-00010A	TRANSISTOR		
Q4	T0501-00006A	POWER MOS FET		
Q5	T0501-00007A	POWER MOS FET		
Q6	T0507-00010A	TRANSISTOR		
Q7	T0501-00010A	TRANSISTOR		
Q8	T0501-00009A	POWER MOS FET		
Q9	T0507-00009A	TRANSISTOR		
Q10	T0507-00009A	TRANSISTOR		
Q11	T0507-00010A	TRANSISTOR		
Q12	T0501-00008A	POWER MOS FET		
Q13	T0507-00010A	TRANSISTOR		
Q14	T0507-00009A	TRANSISTOR		
U1	T1001-00091A	IC		
U2	T1001-00092A	IC		
U3	T1001-00096A	IC		
U4	T1001-00031A	IC		
U5	T1001-00092A	IC		
U6	T1001-00031A	IC		
U7	T1001-00093A	IC		

△Ref No.	Part No.	Part Name	Description Local	△Ref No.	Part No.	Part Name	Description Local
D11	T0407-00001A	DIODE		R23	T2007-IC222J	C RESISTOR	2.2KΩ J
D12	T0402-00013A	DIODE		R24	T2007-JC470J	C RESISTOR	47Ω J
D14	T0402-00017A	DIODE		R25	T2007-IC103J	C RESISTOR	10KΩ J
D15	T0402-00017A	DIODE		R26	T2007-IC102J	C RESISTOR	1KΩ J
D16	T0407-00001A	DIODE		R27	T2003-ET823A	MF RESISTOR	82KΩ 3W J
D17	T0407-00001A	DIODE		R28	T2007-IC153J	C RESISTOR	15KΩ J
D18	T0407-00001A	DIODE		R29	T2007-IC222J	C RESISTOR	2.2KΩ J
C2	T2306-TB105A	F CAPACITOR	1uF 630V J	R30	T2007-IC153J	C RESISTOR	15KΩ J
C3	T2203-FC103E	C CAPACITOR	0.01uF 50V K	R31	T2007-IC102J	C RESISTOR	1KΩ J
C4	T2203-FC101E	C CAPACITOR	0.01uF 50V J	R32	T2007-IC153J	C RESISTOR	15KΩ J
C5	T2203-DC105E	C CAPACITOR	1uF 16V K	R33	T2003-CT4R7R	MF RESISTOR	4.7Ω 1W J
C6	T2203-DC105E	C CAPACITOR	1uF 16V K	R34	T2003-ET470A	MF RESISTOR	47Ω 3W J
C7	T2401-ET1000	E CAPACITOR	10uF 35V	R35	T2007-IC103J	C RESISTOR	10KΩ J
C8	T2203-FC104E	C CAPACITOR	0.1uF 50V K	R36	T2007-IC103J	C RESISTOR	10KΩ J
C9	T2203-FC104E	C CAPACITOR	0.1uF 50V K	R37	T2007-IC273J	C RESISTOR	27KΩ J
C10	T2201-PB103A	C CAPACITOR	0.01uF 1KV Z	R38	T2003-ET220A	MF RESISTOR	22Ω 3W J
C11	T2401-NB1500	E CAPACITOR	150uF 450V	R39	T2007-JC122J	C RESISTOR	1.2KΩ J
C12	T2401-FT2200	E CAPACITOR	22uF 50V	R40	T2007-IC392J	C RESISTOR	3.9KΩ J
C13	T2203-FC104E	C CAPACITOR	0.1uF 50V K	R41	T2007-IC222J	C RESISTOR	2.2KΩ J
C14	T2203-FC102E	C CAPACITOR	1000pF 50V K	R42	T2007-IC471J	C RESISTOR	470Ω J
C15	T2203-FC102E	C CAPACITOR	1000pF 50V K	R43	T2007-IC222J	C RESISTOR	2.2KΩ J
C16	T2306-TB472A	F CAPACITOR	4700pF 630V K	R44	T2007-IC101J	C RESISTOR	100Ω J
C17	T2203-DC474E	C CAPACITOR	0.47uF 25V K	R45	T2007-IC101F	C RESISTOR	100Ω F
C18	T2401-ET1010	E CAPACITOR	100uF 35V	R46	T2007-IC202F	C RESISTOR	2KΩ F
C19	T2201-PB222A	C CAPACITOR	2200pF 1KV K	R47	T2007-IC202F	C RESISTOR	2KΩ F
C20	T2401-DT4710	E CAPACITOR	470uF 25V	R48	T2003-CT1R5R	MF RESISTOR	1.5Ω 1W J
C22	T2401-DT1020	E CAPACITOR	1000uF 25V	R49	T2007-IC153J	C RESISTOR	15KΩ J
C23	T2203-FC104E	C CAPACITOR	0.1uF 50V K	R50	T2007-IC103J	C RESISTOR	10KΩ J
C24	T2201-PB102A	C CAPACITOR	1000pF 1KV K	R51	T2007-IC153J	C RESISTOR	15KΩ J
C25	T2401-BT3320	E CAPACITOR	3300uF 10V	R52	T2007-IC100J	C RESISTOR	10Ω J
C26	T2401-BT3320	E CAPACITOR	3300uF 10V	R53	T2007-JC470J	C RESISTOR	47Ω J
C27	T2401-BT1020	E CAPACITOR	1000uF 10V	R54	T2007-IC103J	C RESISTOR	10KΩ J
C28	T2203-FC104E	C CAPACITOR	0.1uF 50V K	R55	T2003-ET224A	MF RESISTOR	220KΩ 3W J
C29	T2401-ET1010	E CAPACITOR	100uF 35V	R56	T2003-ET224A	MF RESISTOR	220KΩ 3W J
C30	T2203-FC104E	C CAPACITOR	0.1uF 50V K	R57	T2007-IC123F	C RESISTOR	12KΩ F
C31	T2203-DC474E	C CAPACITOR	0.47uF 25V K	R58	T2007-IC153J	C RESISTOR	15KΩ J
C32	T2401-FT2200	E CAPACITOR	22uF 50V	R59	T2007-IC103J	C RESISTOR	10KΩ J
C33	T2203-FC104E	C CAPACITOR	0.1uF 50V K	R60	T2003-ET220A	MF RESISTOR	22Ω 3W J
C34	T2203-FC102E	C CAPACITOR	1000pF 50V K	R61	T2007-IC153J	C RESISTOR	15KΩ J
C35	T2203-FC102E	C CAPACITOR	1000pF 50V K	R62	T2007-JC122J	C RESISTOR	1.2KΩ J
C36	T2203-FC102E	C CAPACITOR	1000pF 50V K	R63	T2007-JC122J	C RESISTOR	1.2KΩ J
C37	T2203-FC104E	C CAPACITOR	0.1uF 50V K	R64	T2007-IC222J	C RESISTOR	2.2KΩ J
C38	T2203-FC104E	C CAPACITOR	0.1uF 50V K	R65	T2007-IC101J	C RESISTOR	100Ω J
C39	T2306-TB472A	F CAPACITOR	4700pF 630V K	R66	T2007-IC153F	C RESISTOR	15KΩ F
C40	T2203-FC104E	C CAPACITOR	0.1uF 50V K	R67	T2007-IC242F	C RESISTOR	2.4KΩ F
C41	T2201-PB102A	C CAPACITOR	1000pF 1KV K	R68	T2007-IC202F	C RESISTOR	2KΩ F
C42	T2401-ET2220	E CAPACITOR	2200uF 35V	R69	T2007-IC123F	C RESISTOR	12KΩ F
C43	T2401-ET2220	E CAPACITOR	2200uF 35V	R70	T2007-IC152J	C RESISTOR	1.5KΩ J
C44	T2401-ET1220	E CAPACITOR	1200uF 35V	R71	T2007-IC181J	C RESISTOR	180Ω J
C45	T2203-FC104E	C CAPACITOR	0.1uF 50V K	R72	T2007-IC181J	C RESISTOR	180Ω J
C46	T2203-FC104E	C CAPACITOR	0.1uF 50V K	R73	T2007-IC123F	C RESISTOR	12KΩ F
C47	T2203-DC474E	C CAPACITOR	0.47uF 25V K	R74	T2007-IC153J	C RESISTOR	15KΩ J
C48	T2203-DC474E	C CAPACITOR	0.47uF 25V K	R75	T2007-IC683J	C RESISTOR	68KΩ J
C49	T2203-FC104E	C CAPACITOR	0.1uF 50V K	R76	T2007-IC222J	C RESISTOR	2.2KΩ J
C50	T2401-ET1000	E CAPACITOR	10uF 35V	R77	T2007-IC562J	C RESISTOR	5.6KΩ J
C52	T2301-HT104A	F CAPACITOR	0.1uF 100V K	R78	T2007-JC331J	C RESISTOR	330Ω J
C21A	T2401-DT4710	E CAPACITOR	470uF 25V	R79	T2007-IC562J	C RESISTOR	5.6KΩ J
C21B	T2401-DT4710	E CAPACITOR	470uF 25V	R80	T2007-IC562J	C RESISTOR	5.6KΩ J
C27B	T2401-BT1020	E CAPACITOR	1000uF 10V	R81	T2007-IC153J	C RESISTOR	15KΩ J
△CX1	T2306-U 105A	F CAPACITOR	1uF 275V	R82	T2007-IC102J	C RESISTOR	1KΩ J
△CX3	T2306-U 474A	F CAPACITOR	0.47uF 275V	R83	T2007-IC153J	C RESISTOR	15KΩ J
△CX5	T2201-MB102A	C CAPACITOR	1000pF	R84	T2007-IC562J	C RESISTOR	5.6KΩ J
△CX6	T2201-MB102A	C CAPACITOR	1000pF	R85	T2007-IC102J	C RESISTOR	1KΩ J
△CY1	T2201-MB102A	C CAPACITOR	1000pF	R87	T2007-IC103J	C RESISTOR	10KΩ J
CY2	2201-000987	C CAPACITOR	2200pF	R88	T2007-IC222J	C RESISTOR	2.2KΩ J
R1	T2007-IC364J	C RESISTOR	360KΩ J	R89	T2007-IC102J	C RESISTOR	1KΩ J
R2	T2007-IC474J	C RESISTOR	470KΩ J	R34B	T2003-ET470A	MF RESISTOR	47Ω 3W J
R3	T2007-IC434J	C RESISTOR	430KΩ J	RX	T2007-JC564J	C RESISTOR	560KΩ J
R4	T2007-IC564J	C RESISTOR	560KΩ J	RX1	T2007-JC564J	C RESISTOR	560KΩ J
R5	T2007-IC123F	C RESISTOR	12KΩ F	RX2	T2007-JC564J	C RESISTOR	560KΩ J
R6	T2007-IC102J	C RESISTOR	1KΩ J	L1	TV49-00005A	CHOKE BAR	5.5uH
R6	T2007-IC273J	C RESISTOR	27KΩ J	L3	TV09-00004A	CHOKE BAR	5.0uH
R7	T2007-IC221J	C RESISTOR	220Ω J	L4	TA49-00004A	INDUCTOR FILTER	100uH 7A
R8	T2007-IC273J	C RESISTOR	27KΩ J	T1	TV26-3L01A	TRANSFOMER	
R9	T2007-IC222J	C RESISTOR	2.2KΩ J	T2	TV26-26L02A	TRANSFOMER	
R10	T2007-IC100J	C RESISTOR	10Ω J	T3	TV26-26L03A	TRANSFOMER	
R11	T2007-JC470J	C RESISTOR	47Ω J	BD1	T0402-00018A	BRIDGE-DIODE	
R12	T2007-IC102J	C RESISTOR	1KΩ J	△CN1	T3711-00039	CONNECTOR	
R13	T2007-IC304J	C RESISTOR	300KΩ J	CN2	T3711-00040	CONNECTOR	
R14	T2007-IC304J	C RESISTOR	300KΩ J	CN3	T3711-00041	CONNECTOR	
R15	T2007-IC304J	C RESISTOR	300KΩ J	△FU1	3601-000297	FUSE	250V 5A
R16	T2007-IC304J	C RESISTOR	300KΩ J	LF1	AB63-00012A	LINE FILTER	15mH 4A
R17	T2007-IC752F	C RESISTOR	7.5KΩ F	LF2	AB63-00012A	LINE FILTER	15mH 4A
R18	T2007-IC391J	C RESISTOR	390Ω J	NT1	T1404-00001A	THERMISTOR	
R19	T2007-IC471J	C RESISTOR	470Ω J	PC1	T1001-00094A	PHOTO COUPLER	
R20	T2007-IC682J	C RESISTOR	6.8KΩ J	PC2	T1001-00094A	PHOTO COUPLER	
R21	T2007-IC682J	C RESISTOR	6.8KΩ J	PC3	T1001-00094A	PHOTO COUPLER	
R22	T2007-IC682J	C RESISTOR	6.8KΩ J				

△Ref No.	Part No.	Part Name	Description Local
RC1	T2007-JC224J	C RESISTOR	220KΩ J
RC2	T2007-JC224J	C RESISTOR	220KΩ J
RC3	T2007-JC224J	C RESISTOR	220KΩ J
RS1	T2003-ETR15A	R-WIRE	0.2Ω 3W J
RS2	T2003-ETR62A	R-WIRE	0.62Ω 3W J
RS3	T2003-ET0R2A	R-WIRE	0.2Ω 3W J
SC1	T0501-00011A	SCR	0.8A 30V
△VX1	T1405-0011A	VARIATOR	
△VX4	T1405-0011A	VARIATOR	
ZD1	T0408-00007A	Z DIODE	
ZD2	T0408-00006A	Z DIODE	
ZD3	T0408-00008A	Z DIODE	
ZD4	T0408-00007A	Z DIODE	
ZD5	T0408-00005A	Z DIODE	
ZD6	T0408-00005A	Z DIODE	
ZD7	T0408-00005A	Z DIODE	
ZD8	T0408-00008A	Z DIODE	
ZD9	T0408-00007A	Z DIODE	
ZD10	T0408-00006A	Z DIODE	

LED P.W. BOARD ASS'Y (QAL0827-001)

△Ref No.	Part No.	Part Name	Description Local
IR201	TA59-00037A	IR RECEIVER	
Q201	T0507-00001A	TRANSISTOR	
Q204	T0507-00001A	TRANSISTOR	
C237	T2203-FC102D	C CAPACITOR	1000pF 50V K
R201	2007-000084	C RESISTOR	4.7KΩ 1/16W J
R202	2007-000078	C RESISTOR	1KΩ 1/16W J
R203	2007-000309	C RESISTOR	10Ω 1/16W J
R204	2007-000081	C RESISTOR	2.7KΩ 1/16W J
R297	2007-000090	C RESISTOR	10KΩ 1/16W J
R298	2007-000090	C RESISTOR	10KΩ 1/16W J
CE201	2401-001495	E CAPACITOR	47uF 16V M
J210	T3711-00034	CONNECTOR	
J211	T3711-00034	CONNECTOR	
LD201	T0601-00002A	LED	POWER

KEY P.W. BOARD ASS'Y (QAL0828-001)

△Ref No.	Part No.	Part Name	Description Local
D201	T0407-00004A	DIODE	
C246	T2203-FC332D	C CAPACITOR	3300pF 50V K
C247	T2203-FC332D	C CAPACITOR	3300pF 50V K
R205	2007-000122	C RESISTOR	1.2KΩ 1/16W J
R206	2007-000120	C RESISTOR	680Ω 1/16W J
R207	2007-000124	C RESISTOR	2.2KΩ 1/16W J
R208	2007-000122	C RESISTOR	1.2KΩ 1/16W J
R209	2007-000120	C RESISTOR	680Ω 1/16W J
R293	2007-000113	C RESISTOR	33Ω 1/16W J
L226	T2901-AC002A	CHIP BEAD	80Ω
L227	T2901-AC002A	CHIP BEAD	80Ω
L240	T2901-CC004A	CHIP BEAD	500Ω
J207	T3722-0043A	JACK	HEADPHONE
J209	T3711-00035	CONNECTOR	
S201	T3404-00004A	TACT SWITCH	POWER
S202	T3404-00004A	TACT SWITCH	TV/AV
S203	T3404-00004A	TACT SWITCH	MENU/OK
S204	T3404-00004A	TACT SWITCH	CH+
S205	T3404-00004A	TACT SWITCH	CH-
S206	T3404-00004A	TACT SWITCH	VOL+
S207	T3404-00004A	TACT SWITCH	VOL-
ZD228	T0408-00002A	Z DIODE	
ZD229	T0408-00002A	Z DIODE	

PRINTED WIRING BOARD PARTS LIST [LT-26A61SJ, LT-26A61SU]

MAIN P.W. BOARD ASS'Y (QAL0822-001)

△Ref No.	Part No.	Part Name	Description Local	△Ref No.	Part No.	Part Name	Description Local
				ZD213	T2901-HC002A	Z DIODE	
				ZD214	T2901-HC011A	Z DIODE	
				ZD215	T2901-HC011A	Z DIODE	
			(SERVICE)	ZD216	T2901-HC011A	Z DIODE	
U101	T1001-00081A	IC		ZD217	T2901-HC011A	Z DIODE	
U202	ATF02-26A61SJ	IC	(SERVICE)	ZD218	T2901-HC011A	Z DIODE	
U301	T1001-00073A-61	IC		ZD219	T2901-JC005A	Z DIODE	
U302	T1001-00064A	IC	(SERVICE)	ZD221	T2901-JC005A	Z DIODE	
U303	ATF32-26A61SJ	IC		ZD222	T2901-JC005A	Z DIODE	
U401	T1001-00084A	IC		ZD227	T2901-JC005A	Z DIODE	
U402	T1001-00085A	IC		ZD230	T2901-JC005A	Z DIODE	
U405	T1001-00075A	IC		ZD231	T2901-JC012B	Z DIODE	
U501	T1001-00086A	IC		ZD232	T2901-JC012B	Z DIODE	
U502	T1001-00063A	IC		ZD250	T2901-JC012B	Z DIODE	
U601	T1001-00087A	IC		ZD251	T2901-JC012B	Z DIODE	
U602	T1001-00088A	IC		ZD252	T2901-JC012B	Z DIODE	
U603	T1001-00070A	IC		ZD253	T2901-JC010B	Z DIODE	
U801	T0407-00004A	TRANSISTOR		ZD254	T2901-JC010B	Z DIODE	
U802	T0407-00004A	TRANSISTOR		ZD255	T2901-JC010B	Z DIODE	
Q101	T1001-00052A	IC		ZD256	T2901-JC010B	Z DIODE	
Q102	T0507-00001A	TRANSISTOR		ZD257	T2901-JC010B	Z DIODE	
Q103	T0507-00001A	TRANSISTOR		ZD258	T2901-JC004A	Z DIODE	
Q104	T0507-00001A	TRANSISTOR		ZD259	T2901-JC004A	Z DIODE	
Q105	T0507-00006A	TRANSISTOR		ZD260	T2901-JC004A	Z DIODE	
Q106	T0507-00001A	TRANSISTOR		ZD261	T2901-JC004A	Z DIODE	
Q202	T0507-00001A	TRANSISTOR		ZD262	T2901-JC004A	Z DIODE	
Q203	T0507-00005A	TRANSISTOR		ZD263	T2703-KC007A	Z DIODE	
Q301	T1001-00049A	IC		ZD264	T2703-KC007A	Z DIODE	
Q303	T1001-00078A	IC		ZD267	T2703-KC007A	Z DIODE	
Q304	T0507-00003A	TRANSISTOR		ZD270	T2703-KC007A	Z DIODE	
Q305	T0507-00003A	TRANSISTOR		ZD271	T2703-KC007A	Z DIODE	
Q306	T0507-00007A	TRANSISTOR		ZD280	T2703-KC014A	Z DIODE	
Q307	T0407-00003A	TRANSISTOR		ZD281	T2703-KC014A	Z DIODE	
Q308	T0507-00005A	TRANSISTOR		ZD702	T2703-JC011A	DIODE	
Q309	T0507-00005A	TRANSISTOR		ZD2213	T2703-KC014A	Z DIODE	
Q311	T0507-00005A	TRANSISTOR		ZD2214	T2703-KC014A	Z DIODE	
Q312	T0507-00006A	TRANSISTOR		ZD2215	T2703-KC014A	Z DIODE	
Q315	T0507-00006A	TRANSISTOR		ZD2216	T2703-LC010A	Z DIODE	
Q316	T0507-00005A	TRANSISTOR		ZD2274	T2703-LC010A	Z DIODE	
Q317	T0407-00003A	TRANSISTOR					
Q403	T0507-00006A	TRANSISTOR					
Q501	T1001-00079A	IC		C101	T0407-00002A	C CAPACITOR	100nF 25V K
Q502	T1001-00048A	IC		C103	2007-000094	C CAPACITOR	10uF 10V Z
Q503	T0507-00007A	TRANSISTOR		C105	2007-000093	C CAPACITOR	100nF 50V Z
Q601	T0507-00006A	TRANSISTOR		C106	2007-000094	C CAPACITOR	10uF 10V Z
Q602	T0507-00002A	TRANSISTOR		C107	2007-000094	C CAPACITOR	10uF 10V Z
Q603	T0507-00002A	TRANSISTOR		C109	2007-000094	C CAPACITOR	10uF 10V Z
Q604	T0407-00002A	TRANSISTOR		C110	2007-000094	C CAPACITOR	10uF 10V Z
Q701	T0507-00002A	TRANSISTOR		C113	2007-000129	C CAPACITOR	10uF 10V Z
Q702	T0507-00002A	TRANSISTOR		C201	T0507-00005A	C CAPACITOR	1nF 50V K
Q703	T0507-00002A	TRANSISTOR		C202	2007-000081	C CAPACITOR	47nF 50V K
Q801	T1001-00089A	IC		C203	2007-000081	C CAPACITOR	47nF 50V K
Q802	T0507-00008A	TRANSISTOR		C204	2007-000081	C CAPACITOR	47nF 50V K
Q804	T1001-00051A	IC		C205	2007-000081	C CAPACITOR	47nF 50V K
Q805	T0507-00008A	TRANSISTOR		C206	2007-000081	C CAPACITOR	47nF 50V K
Q806	T0507-00008A	TRANSISTOR		C207	2007-000082	C CAPACITOR	47nF 50V K
Q2203	T0407-00002A	TRANSISTOR		C208	2007-000082	C CAPACITOR	47nF 50V K
				C209	2007-000082	C CAPACITOR	47nF 50V K
D101	T0408-00002A	DIODE		C210	T0507-00005A	C CAPACITOR	1nF 50V K
D205	T2703-IC002A	Z DIODE		C211	2007-000082	C CAPACITOR	47nF 50V K
D206	T2703-IC002A	Z DIODE		C213	T1001-00089A	C CAPACITOR	10pF 50V K
D207	T2703-IC002A	Z DIODE		C214	T1001-00089A	C CAPACITOR	10pF 50V K
D208	T2703-IC002A	Z DIODE		C215	T1001-00089A	C CAPACITOR	10pF 50V K
D209	T2703-IC002A	Z DIODE		C216	2007-000120	C CAPACITOR	0.47nF 50V K
D210	T2703-IC002A	Z DIODE		C218	2007-000120	C CAPACITOR	0.47nF 50V K
D222	2007-000070	DIODE		C219	2007-000120	C CAPACITOR	0.47nF 50V K
D223	2007-000070	DIODE		C220	2007-000120	C CAPACITOR	0.47nF 50V K
D224	2007-000070	DIODE		C221	2007-000120	C CAPACITOR	0.47nF 50V K
D225	2007-000070	DIODE		C222	2007-000121	C CAPACITOR	0.47nF 50V K
D226	2007-000070	DIODE		C223	2007-000121	C CAPACITOR	0.47nF 50V K
D227	2007-000882	DIODE		C226	2007-000121	C CAPACITOR	0.47nF 50V K
D228	2007-000882	DIODE		C227	2007-000082	C CAPACITOR	47nF 50V K
D229	2007-000882	DIODE		C228	2007-000084	C CAPACITOR	47nF 50V K
D301	T0408-00002A	DIODE		C229	2007-000084	C CAPACITOR	47nF 50V K
D601	T0408-00002A	DIODE		C230	2007-000121	C CAPACITOR	0.47nF 50V K
D602	T0408-00002A	DIODE		C233	2007-000121	C CAPACITOR	0.47nF 50V K
D702	T0408-00002A	DIODE		C234	2007-000078	C CAPACITOR	0.47nF 50V K
D704	T0408-00002A	DIODE		C235	2007-000078	C CAPACITOR	0.47nF 50V K
D801	T0407-00005A	DIODE		C236	T1001-00089A	C CAPACITOR	10pF 50V K
ZD101	T0408-00009A	Z DIODE		C238	T1001-00089A	C CAPACITOR	10pF 50V K
ZD202	T0408-00009A	Z DIODE		C242	2007-000643	C CAPACITOR	0.33nF 50V K
ZD203	T0408-00009A	Z DIODE		C243	2007-000643	C CAPACITOR	0.33nF 50V K
ZD204	T0408-00009A	Z DIODE		C244	2007-000643	C CAPACITOR	0.33nF 50V K
ZD206	T0408-00009A	Z DIODE		C248	2007-000077	C CAPACITOR	330nF 16V Z
ZD209	T2901-HC002A	Z DIODE		C249	2007-000077	C CAPACITOR	330nF 16V Z
ZD210	T2901-HC002A	Z DIODE		C252	T0407-00002A	C CAPACITOR	100nF 25V K
ZD211	T2901-HC002A	Z DIODE		C253	T0407-00002A	C CAPACITOR	100nF 25V K
ZD212	T2901-HC002A	Z DIODE		C254	T0407-00002A	C CAPACITOR	100nF 25V K

△Ref No.	Part No.	Part Name	Description Local	△Ref No.	Part No.	Part Name	Description Local
C255	T0407-00002A	C CAPACITOR	100nF 25V K	C516	T2703-KC014A	C CAPACITOR	100nF 25V K
C256	T0407-00004A	C CAPACITOR	100nF 25V K	C517	T2703-LC010A	C CAPACITOR	100nF 25V K
C257	T0407-00004A	C CAPACITOR	100nF 25V K	C518	T2703-LC010A	C CAPACITOR	100nF 25V K
C258	T0407-00004A	C CAPACITOR	100nF 25V K	C519	T2703-LC010A	C CAPACITOR	100nF 25V K
C259	T0407-00004A	C CAPACITOR	100nF 25V K	C520	T2703-LC010A	C CAPACITOR	100nF 25V K
C301	T0407-00004A	C CAPACITOR	100nF 25V K	C524	T2703-LC010A	C CAPACITOR	100nF 25V K
C302	T0407-00003A	C CAPACITOR	100nF 25V K	C525	T2703-IC002A	C CAPACITOR	100nF 25V K
C303	T0407-00003A	C CAPACITOR	100nF 25V K	C526	T2703-IC002A	C CAPACITOR	100nF 25V K
C304	T0407-00003A	C CAPACITOR	100nF 25V K	C527	T2703-IC002A	C CAPACITOR	100nF 25V K
C305	T0407-00003A	C CAPACITOR	100nF 25V K	C528	T2703-IC002A	C CAPACITOR	100nF 25V K
C306	2007-000074	C CAPACITOR	0.22nF 50V K	C529	T2703-IC002A	C CAPACITOR	100nF 25V K
C307	T0507-00002A	C CAPACITOR	10nF 50V K	C530	T2703-IC002A	C CAPACITOR	100nF 25V K
C308	2007-000075	C CAPACITOR	220nF 50V K	C531	T2703-IC002A	C CAPACITOR	100nF 25V K
C309	T0407-00003A	C CAPACITOR	100nF 25V K	C532	T2703-IC002A	C CAPACITOR	100nF 25V K
C310	T0408-00002A	C CAPACITOR	100nF 25V K	C533	T2703-IC002A	C CAPACITOR	100nF 25V K
C311	T0507-00007A	C CAPACITOR	33pF 50V K	C534	T2703-IC002A	C CAPACITOR	100nF 25V K
C312	T0507-00001A	C CAPACITOR	0.1nF 50V K	C535	T2703-JC011A	C CAPACITOR	100nF 25V K
C313	T0507-00001A	C CAPACITOR	0.1nF 50V K	C536	T2703-JC011A	C CAPACITOR	100nF 25V K
C314	T0507-00001A	C CAPACITOR	0.1nF 50V K	C537	T2703-JC011A	C CAPACITOR	100nF 25V K
C316	T0507-00007A	C CAPACITOR	33pF 50V K	C538	T2703-JC011A	C CAPACITOR	100nF 25V K
C317	T0408-00002A	C CAPACITOR	100nF 25V K	C539	T2703-JC011A	C CAPACITOR	100nF 25V K
C318	T0408-00002A	C CAPACITOR	100nF 25V K	C540	2007-000070	C CAPACITOR	100nF 25V K
C319	T0408-00002A	C CAPACITOR	100nF 25V K	C541	2007-000070	C CAPACITOR	100nF 25V K
C402	T0408-00002A	C CAPACITOR	100nF 25V K	C543	2007-000070	C CAPACITOR	100nF 25V K
C403	T0408-00002A	C CAPACITOR	100nF 25V K	C544	2007-000070	C CAPACITOR	100nF 25V K
C404	T0408-00002A	C CAPACITOR	100nF 25V K	C545	2007-000070	C CAPACITOR	100nF 25V K
C405	T0408-00002A	C CAPACITOR	100nF 25V K	C546	2007-000882	C CAPACITOR	100nF 25V K
C406	T0408-00002A	C CAPACITOR	100nF 25V K	C548	2007-000882	C CAPACITOR	100nF 25V K
C407	T0408-00002A	C CAPACITOR	100nF 25V K	C549	2007-000882	C CAPACITOR	100nF 25V K
C409	T0407-00005A	C CAPACITOR	100nF 25V K	C550	T1001-00051A	C CAPACITOR	10pF 50V K
C411	T0407-00005A	C CAPACITOR	100nF 25V K	C552	2007-000882	C CAPACITOR	100nF 25V K
C412	T0407-00005A	C CAPACITOR	100nF 25V K	C553	T0507-00007A	C CAPACITOR	33pF 50V K
C413	T0407-00005A	C CAPACITOR	100nF 25V K	C554	T0507-00007A	C CAPACITOR	33pF 50V K
C414	T0407-00005A	C CAPACITOR	100nF 25V K	C555	2007-000882	C CAPACITOR	100nF 25V K
C415	T0408-000009A	C CAPACITOR	100nF 25V K	C556	T0507-00005A	C CAPACITOR	1nF 50V K
C416	T0408-000009A	C CAPACITOR	100nF 25V K	C557	T1001-00051A	C CAPACITOR	10pF 50V K
C417	T0408-000009A	C CAPACITOR	100nF 25V K	C559	2007-001134	C CAPACITOR	1uF 16V Z
C419	T0408-000009A	C CAPACITOR	100nF 25V K	C601	2007-000309	C CAPACITOR	100nF 25V K
C420	T0408-000009A	C CAPACITOR	100nF 25V K	C604	2007-000118	C CAPACITOR	3.3nF 50V K
C421	2007-000115	C CAPACITOR	1.5nF 50V K	C605	2007-000118	C CAPACITOR	3.3nF 50V K
C422	2007-000115	C CAPACITOR	1.5nF 50V K	C606	T1001-00048A	C CAPACITOR	6pF 50V K
C423	2007-000115	C CAPACITOR	1.5nF 50V K	C607	T1001-00048A	C CAPACITOR	6pF 50V K
C424	T0507-00001A	C CAPACITOR	0.1nF 50V K	C608	T0507-00006A	C CAPACITOR	47pF 50V K
C425	T0507-00003A	C CAPACITOR	22pF 50V K	C610	2007-000309	C CAPACITOR	100nF 25V K
C426	T0507-00003A	C CAPACITOR	22pF 50V K	C611	T0507-00006A	C CAPACITOR	47pF 50V K
C427	T2901-HC002A	C CAPACITOR	100nF 25V K	C612	T2203-FC100D	C RESISTOR	0Ω 1/16W J
C428	T2901-HC002A	C CAPACITOR	100nF 25V K	C614	2007-000123	C CAPACITOR	4.7nF 50V K
C429	T2901-HC002A	C CAPACITOR	100nF 25V K	C615	2007-000643	C CAPACITOR	0.33nF 50V K
C430	T2901-HC002A	C CAPACITOR	100nF 25V K	C616	2007-000643	C CAPACITOR	0.33nF 50V K
C431	T2901-HC002A	C CAPACITOR	100nF 25V K	C617	2007-000309	C CAPACITOR	100nF 25V K
C432	T2901-HC011A	C CAPACITOR	100nF 25V K	C618	T0507-00002A	C CAPACITOR	10nF 50V K
C433	T2901-HC011A	C CAPACITOR	100nF 25V K	C619	T0507-00002A	C CAPACITOR	10nF 50V K
C434	T2901-HC011A	C CAPACITOR	100nF 25V K	C620	T0507-00002A	C CAPACITOR	10nF 50V K
C435	T2901-HC011A	C CAPACITOR	100nF 25V K	C621	2007-000309	C CAPACITOR	100nF 25V K
C436	T1001-00051A	C CAPACITOR	10pF 50V K	C623	2007-000119	C CAPACITOR	3.9nF 50V K
C438	T2901-HC011A	C CAPACITOR	100nF 25V K	C624	2007-000119	C CAPACITOR	3.9nF 50V K
C439	T2901-JC005A	C CAPACITOR	100nF 25V K	C625	T0507-00005A	C CAPACITOR	1nF 50V K
C440	T2901-JC005A	C CAPACITOR	100nF 25V K	C626	2007-000076	C CAPACITOR	0.33nF 50V K
C441	T2901-JC005A	C CAPACITOR	100nF 25V K	C627	2007-000076	C CAPACITOR	0.33nF 50V K
C442	T2901-JC005A	C CAPACITOR	100nF 25V K	C632	2007-000076	C CAPACITOR	0.33nF 50V K
C443	T2901-JC005A	C CAPACITOR	100nF 25V K	C633	2007-000076	C CAPACITOR	0.33nF 50V K
C444	T2901-JC012B	C CAPACITOR	100nF 25V K	C634	2007-001134	C CAPACITOR	1uF 16V Z
C445	T2901-JC012B	C CAPACITOR	100nF 25V K	C635	2007-001134	C CAPACITOR	1uF 16V Z
C446	T2901-JC012B	C CAPACITOR	100nF 25V K	C636	T0507-00006A	C CAPACITOR	47pF 50V K
C447	T2901-JC012B	C CAPACITOR	100nF 25V K	C638	2007-000309	C CAPACITOR	100nF 25V K
C451	T0507-00002A	C CAPACITOR	10nF 50V K	C639	2007-000090	C CAPACITOR	6.8nF 50V K
C452	T2901-JC012B	C CAPACITOR	100nF 25V K	C640	2007-000090	C CAPACITOR	6.8nF 50V K
C453	T2901-JC010B	C CAPACITOR	100nF 25V K	C701	2007-000071	C CAPACITOR	100nF 25V K
C454	T2901-JC010B	C CAPACITOR	100nF 25V K	C702	2007-000071	C CAPACITOR	100nF 25V K
C455	2007-000078	C CAPACITOR	0.47nF 50V K	C703	T0507-00008A	C CAPACITOR	10nF 50V K
C456	T2901-JC010B	C CAPACITOR	100nF 25V K	C707	2007-000072	C CAPACITOR	100nF 50V K
C457	T2901-JC010B	C CAPACITOR	100nF 25V K	C710	2007-000084	C CAPACITOR	47nF 50V K
C458	T2901-JC010B	C CAPACITOR	100nF 25V K	C712	2007-001167	C CAPACITOR	0.15nF 50V K
C459	2007-001167	C CAPACITOR	0.15nF 50V K	C714	2007-000402	C CAPACITOR	2.2nF 50V K
C460	2007-001167	C CAPACITOR	0.15nF 50V K	C715	T0507-00005A	C CAPACITOR	1nF 50V K
C461	2007-000115	C CAPACITOR	1.5nF 50V K	C801	2007-000071	C CAPACITOR	100nF 25V K
C501	T2901-JC004A	C CAPACITOR	100nF 25V K	C802	2007-000071	C CAPACITOR	100nF 25V K
C502	T2901-JC004A	C CAPACITOR	100nF 25V K	C805	2007-000071	C CAPACITOR	100nF 25V K
C503	T2901-JC004A	C CAPACITOR	100nF 25V K	C806	2007-000113	C CAPACITOR	100nF 25V K
C504	T2901-JC004A	C CAPACITOR	100nF 25V K	C807	2007-000113	C CAPACITOR	100nF 25V K
C506	T2901-JC004A	C CAPACITOR	100nF 25V K	C820	2007-000113	C CAPACITOR	100nF 25V K
C507	T2703-KC007A	C CAPACITOR	100nF 25V K	C821	2007-000113	C CAPACITOR	100nF 25V K
C508	T2703-KC007A	C CAPACITOR	100nF 25V K	C2251	2007-000113	C CAPACITOR	100nF 25V K
C509	T2703-KC007A	C CAPACITOR	100nF 25V K	CA02	T0507-00006A	C CAPACITOR	47pF 50V K
C510	T2703-KC007A	C CAPACITOR	100nF 25V K	CA03	T0507-00006A	C CAPACITOR	47pF 50V K
C511	T2703-KC007A	C CAPACITOR	100nF 25V K				
C512	T2703-KC014A	C CAPACITOR	100nF 25V K	L301	T3711-00037	C RESISTOR	4.7KΩ 1/16W J
C513	T2703-KC014A	C CAPACITOR	100nF 25V K	R101	2401-001363	C RESISTOR	330Ω 1/16W J
C514	T2703-KC014A	C CAPACITOR	100nF 25V K	R102	2401-001363	C RESISTOR	330Ω 1/16W J
C515	T2703-KC014A	C CAPACITOR	100nF 25V K	R104	2401-001363	C RESISTOR	330Ω 1/16W J

△Ref No.	Part No.	Part Name	Description Local	△Ref No.	Part No.	Part Name	Description Local
R107	T2401-BT1010	C RESISTOR	220Ω 1/16W J	R310	T1001-00064A	C RESISTOR	10KΩ 1/16W J
R108	T2203-FC060D	C RESISTOR	0Ω 1/16W J	R313	2401-001495	C RESISTOR	100Ω 1/16W J
R109	T1001-00087A	C RESISTOR	100KΩ 1/16W J	R314	T3711-00037	C RESISTOR	4.7KΩ 1/16W J
R110	T1001-00087A	C RESISTOR	100KΩ 1/16W J	R315	T2203-FC101D	C RESISTOR	10Ω 1/16W J
R114	T1001-00087A	C RESISTOR	100KΩ 1/16W J	R316	T2203-FC101D	C RESISTOR	10Ω 1/16W J
R115	2401-001363	C RESISTOR	330Ω 1/16W J	R317	T2203-FC101D	C RESISTOR	10Ω 1/16W J
R119	2401-001363	C RESISTOR	330Ω 1/16W J	R318	T3711-00035	C RESISTOR	2.7KΩ 1/16W J
R121	T1001-00087A	C RESISTOR	100KΩ 1/16W J	R319	T2203-FC101D	C RESISTOR	10Ω 1/16W J
R123	T2401-CT4710	C RESISTOR	330Ω 1/16W J	R320	2401-001495	C RESISTOR	100Ω 1/16W J
R124	T2401-BT1010	C RESISTOR	220Ω 1/16W J	R321	T3711-00035	C RESISTOR	2.7KΩ 1/16W J
R126	TA40-00016A	C RESISTOR	1KΩ 1/16W J	R322	2401-001495	C RESISTOR	100Ω 1/16W J
R127	T1001-00073A	C RESISTOR	10KΩ 1/16W J	R327	2401-001495	C RESISTOR	100Ω 1/16W J
R128	T1001-00073A	C RESISTOR	10KΩ 1/16W J	R328	T2401-CT4700	C RESISTOR	100Ω 1/16W J
R129	T1001-00073A	C RESISTOR	10KΩ 1/16W J	R329	T2203-FC473D	C RESISTOR	75Ω 1/16W J
R130	TA40-00016A	C RESISTOR	1KΩ 1/16W J	R330	T3711-00037	C RESISTOR	4.7KΩ 1/16W J
R131	T3711-00034	C RESISTOR	1.5KΩ 1/16W J	R331	T2401-CT4700	C RESISTOR	100Ω 1/16W J
R132	T1001-00086A	C RESISTOR	47KΩ 1/16W J	R332	T2203-DC104E	C RESISTOR	22Ω 1/16W J
R133	T2401-BT1010	C RESISTOR	220Ω 1/16W J	R333	T2203-DC104E	C RESISTOR	22Ω 1/16W J
R134	T1001-00073A	C RESISTOR	10KΩ 1/16W J	R335	T1001-00084A	C RESISTOR	22KΩ 1/16W J
R136	T1001-00085A	C RESISTOR	27KΩ 1/16W J	R336	T1001-00086A	C RESISTOR	47KΩ 1/16W J
R138	T1001-00073A	C RESISTOR	10KΩ 1/16W J	R337	T3711-00036	C RESISTOR	3.3KΩ 1/16W J
R210	2401-002075	C RESISTOR	270Ω 1/16W J	R338	T3711-00036	C RESISTOR	3.3KΩ 1/16W J
R211	T2401-FT0R1A	C RESISTOR	100Ω 1/16W J	R339	T3711-00036	C RESISTOR	3.3KΩ 1/16W J
R214	TA40-00016A	C RESISTOR	1KΩ 1/16W J	R340	T2203-DC104E	C RESISTOR	22Ω 1/16W J
R215	TA40-00016A	C RESISTOR	1KΩ 1/16W J	R341	T2401-CT4700	C RESISTOR	100Ω 1/16W J
R216	TA40-00016A	C RESISTOR	1KΩ 1/16W J	R342	T2203-FC101D	C RESISTOR	10Ω 1/16W J
R217	T3722-00054A	C RESISTOR	1KΩ 1/16W J	R343	T3722-00040A	C RESISTOR	1KΩ 1/16W J
R218	T3722-00054A	C RESISTOR	1KΩ 1/16W J	R344	T2401-CT4700	C RESISTOR	100Ω 1/16W J
R219	T3722-00054A	C RESISTOR	1KΩ 1/16W J	R345	T2401-CT4700	C RESISTOR	100Ω 1/16W J
R220	T3722-00054A	C RESISTOR	1KΩ 1/16W J	R346	2401-000914	C RESISTOR	100Ω 1/16W J
R223	T2801-00011A	C RESISTOR	470Ω 1/16W J	R347	2401-000914	C RESISTOR	100Ω 1/16W J
R224	T2203-FC152D	C RESISTOR	33Ω 1/16W J	R348	2401-000914	C RESISTOR	100Ω 1/16W J
R225	T2203-FC392D	C RESISTOR	75Ω 1/16W J	R349	T3711-00037	C RESISTOR	4.7KΩ 1/16W J
R226	T2203-FC152D	C RESISTOR	33Ω 1/16W J	R350	T3711-00037	C RESISTOR	4.7KΩ 1/16W J
R227	T2203-FC392D	C RESISTOR	75Ω 1/16W J	R351	T2203-FC221E	C RESISTOR	33Ω 1/16W J
R228	T2203-FC152D	C RESISTOR	33Ω 1/16W J	R352	T2203-FC221E	C RESISTOR	33Ω 1/16W J
R229	T2203-FC392D	C RESISTOR	75Ω 1/16W J	R353	T2203-FC221E	C RESISTOR	33Ω 1/16W J
R230	T2203-FC152D	C RESISTOR	33Ω 1/16W J	R354	T2203-FC222D	C RESISTOR	33Ω 1/16W J
R231	T2203-FC152D	C RESISTOR	33Ω 1/16W J	R355	2401-000914	C RESISTOR	100Ω 1/16W J
R232	T2801-00011A	C RESISTOR	470Ω 1/16W J	R356	2401-000914	C RESISTOR	100Ω 1/16W J
R233	T2203-FC221E	C RESISTOR	33Ω 1/16W J	R357	T3711-00036	C RESISTOR	3.3KΩ 1/16W J
R235	T2203-FC392D	C RESISTOR	75Ω 1/16W J	R358	2401-000603	C RESISTOR	100Ω 1/16W J
R236	T2203-FC392D	C RESISTOR	75Ω 1/16W J	R359	2401-000603	C RESISTOR	100Ω 1/16W J
R237	T2203-FC104E	C RESISTOR	82Ω 1/16W J	R360	T3711-00036	C RESISTOR	3.3KΩ 1/16W J
R238	T2203-FC104E	C RESISTOR	82Ω 1/16W J	R361	T3711-00019	C RESISTOR	4.7KΩ 1/16W J
R239	T2203-FC104E	C RESISTOR	82Ω 1/16W J	R363	T2801-00014A	C RESISTOR	680Ω 1/16W J
R242	T2203-FC471D	C RESISTOR	75Ω 1/16W J	R364	T2203-FC102D	C RESISTOR	10Ω 1/16W J
R243	T3722-00054A	C RESISTOR	1KΩ 1/16W J	R365	T3711-00019	C RESISTOR	4.7KΩ 1/16W J
R244	T3722-00040A	C RESISTOR	1KΩ 1/16W J	R367	2401-000603	C RESISTOR	100Ω 1/16W J
R245	T2203-FC471D	C RESISTOR	75Ω 1/16W J	R370	T1001-00064A	C RESISTOR	10KΩ 1/16W J
R246	T2203-FC471D	C RESISTOR	75Ω 1/16W J	R371	T2401-CT4710	C RESISTOR	330Ω 1/16W J
R247	T2203-FC471D	C RESISTOR	75Ω 1/16W J	R373	2401-000603	C RESISTOR	100Ω 1/16W J
R248	T1001-00064A	C RESISTOR	10KΩ 1/16W J	R375	T1001-00064A	C RESISTOR	10KΩ 1/16W J
R249	T1001-00064A	C RESISTOR	10KΩ 1/16W J	R376	2401-002075	C RESISTOR	270Ω 1/16W J
R255	T2401-FT0R1A	C RESISTOR	100Ω 1/16W J	R377	T2203-FC060D	C RESISTOR	0Ω 1/16W J
R256	T2203-FC471D	C RESISTOR	75Ω 1/16W J	R378	T3722-00040A	C RESISTOR	1KΩ 1/16W J
R260	T2203-FC472D	C RESISTOR	75Ω 1/16W J	R380	T1001-00083A	C RESISTOR	10KΩ 1/16W J
R261	T1001-00085A	C RESISTOR	27KΩ 1/16W J	R382	2401-000603	C RESISTOR	100Ω 1/16W J
R262	T2203-FC472D	C RESISTOR	75Ω 1/16W J	R383	T2801-00013A	C RESISTOR	560Ω 1/16W J
R263	T2203-FC472D	C RESISTOR	75Ω 1/16W J	R385	2401-002235	C RESISTOR	100Ω 1/16W J
R264	T2203-FC472D	C RESISTOR	75Ω 1/16W J	R390	T3711-00019	C RESISTOR	4.7KΩ 1/16W J
R267	T2203-FC472D	C RESISTOR	75Ω 1/16W J	R391	T2203-FC060D	C RESISTOR	0Ω 1/16W J
R271	T2401-FT0R1A	C RESISTOR	100Ω 1/16W J	R392	T3711-00019	C RESISTOR	4.7KΩ 1/16W J
R272	T2401-FT0R1A	C RESISTOR	100Ω 1/16W J	R393	2401-002235	C RESISTOR	100Ω 1/16W J
R273	2401-002075	C RESISTOR	270Ω 1/16W J	R394	T3722-00040A	C RESISTOR	1KΩ 1/16W J
R274	T2401-FT0R1A	C RESISTOR	100Ω 1/16W J	R395	T2203-FC330D	C RESISTOR	0Ω 1/16W J
R275	T2203-FC060D	C RESISTOR	0Ω 1/16W J	R396	T3711-00029	C RESISTOR	3.3KΩ 1/16W J
R277	T2203-FC060D	C RESISTOR	0Ω 1/16W J	R397	T3711-00029	C RESISTOR	3.3KΩ 1/16W J
R278	T3722-00040A	C RESISTOR	1KΩ 1/16W J	R411	T2801-00011A	C RESISTOR	470Ω 1/16W J
R279	T3722-00040A	C RESISTOR	1KΩ 1/16W J	R412	T2203-FC334D	C RESISTOR	68Ω 1/16W J
R280	T3722-00040A	C RESISTOR	1KΩ 1/16W J	R413	2401-002235	C RESISTOR	100Ω 1/16W J
R281	T2203-FC104E	C RESISTOR	82Ω 1/16W J	R414	T2203-FC222D	C RESISTOR	33Ω 1/16W J
R282	T2203-FC104E	C RESISTOR	82Ω 1/16W J	R415	T2801-00014A	C RESISTOR	680Ω 1/16W J
R283	T2203-BC106E	C RESISTOR	82Ω 1/16W J	R416	T2203-DC104E	C RESISTOR	22Ω 1/16W J
R285	T2203-FC473D	C RESISTOR	75Ω 1/16W J	R417	T2203-DC104E	C RESISTOR	22Ω 1/16W J
R286	T1001-00085A	C RESISTOR	27KΩ 1/16W J	R418	T3711-00019	C RESISTOR	4.7KΩ 1/16W J
R287	T2203-FC470D	C RESISTOR	4.7Ω 1/16W J	R419	T2203-FC100D	C RESISTOR	0Ω 1/16W J
R288	T2203-FC473D	C RESISTOR	75Ω 1/16W J	R427	T1001-00052A	C RESISTOR	1MΩ 1/16W J
R289	T2203-FC473D	C RESISTOR	75Ω 1/16W J	R429	T2203-FC222D	C RESISTOR	33Ω 1/16W J
R290	2401-000269	C RESISTOR	100Ω 1/16W J	R432	T2203-FC222D	C RESISTOR	33Ω 1/16W J
R291	2401-000269	C RESISTOR	100Ω 1/16W J	R434	T2203-FC222D	C RESISTOR	33Ω 1/16W J
R292	T3722-00040A	C RESISTOR	1KΩ 1/16W J	R436	T2203-FC224D	C RESISTOR	33Ω 1/16W J
R294	T2203-FC470D	C RESISTOR	4.7Ω 1/16W J	R442	T2203-FC331D	C RESISTOR	33Ω 1/16W J
R295	T2203-FC473D	C RESISTOR	75Ω 1/16W J	R456	T3711-00038	C RESISTOR	4.7KΩ 1/16W J
R296	T3722-00040A	C RESISTOR	1KΩ 1/16W J	R457	T2203-FC682D	C RESISTOR	75Ω 1/16W J
R299	T2203-FC221E	C RESISTOR	33Ω 1/16W J	R458	T2203-FC682D	C RESISTOR	75Ω 1/16W J
R304	2401-000269	C RESISTOR	100Ω 1/16W J	R459	T2203-FC682D	C RESISTOR	75Ω 1/16W J
R305	2401-000269	C RESISTOR	100Ω 1/16W J	R460	T3711-00038	C RESISTOR	4.7KΩ 1/16W J
R307	2401-000269	C RESISTOR	100Ω 1/16W J	R461	T1001-00070A	C RESISTOR	470KΩ 1/16W J
R308	2401-001495	C RESISTOR	100Ω 1/16W J	R462	T3711-00038	C RESISTOR	4.7KΩ 1/16W J

△Ref No.	Part No.	Part Name	Description Local	△Ref No.	Part No.	Part Name	Description Local
R501	T1001-00083A	C RESISTOR	10KΩ 1/16W J	R712	T1001-00088A	C RESISTOR	100KΩ 1/16W J
R504	T3711-00038	C RESISTOR	4.7KΩ 1/16W J	R713	T1001-00084A	C RESISTOR	22KΩ 1/16W J
R505	T1001-00087A	C RESISTOR	100KΩ 1/16W J	R801	T1001-00083A	C RESISTOR	10KΩ 1/16W J
R509	2007-001167	CHIP BEAD	30Ω	R802	T3711-00037	C RESISTOR	4.7KΩ 1/16W J
R510	2007-001167	CHIP BEAD	30Ω	R803	2401-002075	C RESISTOR	270Ω 1/16W J
R511	2007-001167	CHIP BEAD	30Ω	R804	AA60-40014A	C RESISTOR	4.7KΩ 1/16W J
R515	2007-001167	CHIP BEAD	30Ω	R805	AA60-40014A	C RESISTOR	4.7KΩ 1/16W J
R516	2007-001167	CHIP BEAD	30Ω	R806	AA60-40014A	C RESISTOR	4.7KΩ 1/16W J
R517	2007-000115	CHIP BEAD	30Ω	R810	T2203-FC220D	C RESISTOR	0Ω 1/16W J
R518	2007-000115	CHIP BEAD	30Ω	R2215	T2203-FC332D	C RESISTOR	47Ω 1/16W J
R519	2007-000115	CHIP BEAD	30Ω	R2219	T2203-FC104D	C RESISTOR	22Ω 1/16W J
R529	T2203-FC100D	C RESISTOR	0Ω 1/16W J	R2220	T2203-FC104D	C RESISTOR	22Ω 1/16W J
R540	T2203-FC102D	C RESISTOR	10Ω 1/16W J	R2221	T2203-FC104D	C RESISTOR	22Ω 1/16W J
R541	2007-000115	CHIP BEAD	30Ω	R2222	T2203-FC104D	C RESISTOR	22Ω 1/16W J
R542	2007-000115	CHIP BEAD	30Ω	R2223	T2203-CC105D	C RESISTOR	22Ω 1/16W J
R543	2007-000074	CHIP BEAD	30Ω	R2224	T2203-CC105D	C RESISTOR	22Ω 1/16W J
R544	T2203-FC104D	C RESISTOR	22Ω 1/16W J	R2225	T2203-CC105D	C RESISTOR	22Ω 1/16W J
R546	2007-000074	CHIP BEAD	30Ω	R2226	T2203-CC105D	C RESISTOR	22Ω 1/16W J
R548	2007-000074	CHIP BEAD	30Ω	R2227	T2203-CC105D	C RESISTOR	22Ω 1/16W J
R550	2007-000074	CHIP BEAD	30Ω	R2228	T2203-FC150D	C RESISTOR	22Ω 1/16W J
R560	2007-000074	CHIP BEAD	30Ω	R2290	T3711-00033	C RESISTOR	1KΩ 1/16W J
R561	2007-000402	CHIP BEAD	30Ω	R2291	AA60-40014A	C RESISTOR	4.7KΩ 1/16W J
R562	2007-000402	CHIP BEAD	30Ω	R2292	AA60-40014A	C RESISTOR	4.7KΩ 1/16W J
R563	2007-000402	CHIP BEAD	30Ω	R2293	T1001-00081A	C RESISTOR	4.7KΩ 1/16W J
R565	2007-000402	CHIP BEAD	30Ω	RA01	T2203-FC220D	C RESISTOR	0Ω 1/16W J
R566	T2203-FC102D	C RESISTOR	10Ω 1/16W J	RA02	T2203-FC330D	C RESISTOR	0Ω 1/16W J
R567	2007-000402	CHIP BEAD	30Ω	RA03	T2203-FC331D	C RESISTOR	33Ω 1/16W J
R568	T2203-FC102D	C RESISTOR	10Ω 1/16W J	RA04	T2203-FC224D	C RESISTOR	33Ω 1/16W J
R571	T2203-FC334D	C RESISTOR	68Ω 1/16W J	RA05	T2203-FC224D	C RESISTOR	33Ω 1/16W J
R572	T2203-FC334D	C RESISTOR	68Ω 1/16W J	RA06	T2203-FC224D	C RESISTOR	33Ω 1/16W J
R573	T2203-FC334D	C RESISTOR	68Ω 1/16W J	RA07	T2203-FC224D	C RESISTOR	33Ω 1/16W J
R574	2401-002235	C RESISTOR	100Ω 1/16W J	RA08	T2203-FC331D	C RESISTOR	33Ω 1/16W J
R575	T2203-FC334D	C RESISTOR	68Ω 1/16W J	RA09	T2203-FC331D	C RESISTOR	33Ω 1/16W J
R577	2007-000075	CHIP BEAD	30Ω	RA10	T2203-FC331D	C RESISTOR	33Ω 1/16W J
R579	2007-000075	CHIP BEAD	30Ω	L201	2007-000309	CHIP BEAD	80Ω
R582	2007-000075	CHIP BEAD	30Ω	L202	2007-000309	CHIP BEAD	80Ω
R583	2007-000075	CHIP BEAD	30Ω	L203	2007-000309	CHIP BEAD	80Ω
R584	2007-000075	CHIP BEAD	30Ω	L204	2007-000309	CHIP BEAD	80Ω
R585	2007-000643	CHIP BEAD	30Ω	L205	2007-000309	CHIP BEAD	80Ω
R586	2007-000643	CHIP BEAD	30Ω	L206	2007-000071	CHIP BEAD	80Ω
R587	2007-000643	CHIP BEAD	30Ω	L207	2007-000071	CHIP BEAD	80Ω
R588	2007-000643	CHIP BEAD	30Ω	L208	2007-000071	CHIP BEAD	80Ω
R589	T2203-FC220D	C RESISTOR	0Ω 1/16W J	L209	2007-000071	CHIP BEAD	80Ω
R591	2007-000643	CHIP BEAD	30Ω	L210	2007-000071	CHIP BEAD	80Ω
R592	2007-000076	CHIP BEAD	30Ω	L211	2007-000113	CHIP BEAD	80Ω
R593	T3722-00040A	C RESISTOR	1KΩ 1/16W J	L214	2007-000113	CHIP BEAD	80Ω
R594	T3722-00041A	C RESISTOR	1KΩ 1/16W J	L215	2007-000113	CHIP BEAD	80Ω
R595	T3711-00038	C RESISTOR	4.7KΩ 1/16W J	L216	2007-000113	CHIP BEAD	80Ω
R596	T3711-00037	C RESISTOR	4.7KΩ 1/16W J	L217	2007-000113	CHIP BEAD	80Ω
R597	T2401-BT102A	C RESISTOR	390Ω 1/16W J	L218	2007-000072	CHIP BEAD	80Ω
R601	T3722-00041A	C RESISTOR	1KΩ 1/16W J	L219	2007-000072	CHIP BEAD	80Ω
R602	T1001-00063A	C RESISTOR	68KΩ 1/16W J	L220	2007-000072	CHIP BEAD	80Ω
R603	2401-000242	C RESISTOR	150Ω 1/16W J	L221	2007-000072	CHIP BEAD	80Ω
R604	T3711-00037	C RESISTOR	4.7KΩ 1/16W J	L302	2007-000072	CHIP BEAD	80Ω
R605	T3722-00041A	C RESISTOR	1KΩ 1/16W J	L303	2007-001134	CHIP BEAD	80Ω
R606	T1001-00086A	C RESISTOR	47KΩ 1/16W J	L304	2007-001134	CHIP BEAD	80Ω
R607	T3711-00037	C RESISTOR	4.7KΩ 1/16W J	L305	2007-001134	CHIP BEAD	80Ω
R608	T1001-00075A	C RESISTOR	30KΩ 1/16W J	L306	2007-000093	CHIP BEAD	500Ω
R609	T3722-00041A	C RESISTOR	1KΩ 1/16W J	L317	T2007-HC330J	CHIP COIL	10uH
R610	T1001-00075A	C RESISTOR	30KΩ 1/16W J	L401	2007-000093	CHIP BEAD	500Ω
R611	T3722-00041A	C RESISTOR	1KΩ 1/16W J	L402	2007-000093	CHIP BEAD	500Ω
R612	T1001-00086A	C RESISTOR	47KΩ 1/16W J	L404	2007-000093	CHIP BEAD	500Ω
R613	2401-002235	C RESISTOR	100Ω 1/16W J	L405	2007-000093	CHIP BEAD	500Ω
R614	2401-002594	C RESISTOR	100Ω 1/16W J	L406	2007-000094	CHIP BEAD	500Ω
R615	2401-002594	C RESISTOR	100Ω 1/16W J	L408	2007-000094	CHIP BEAD	500Ω
R616	2401-002594	C RESISTOR	100Ω 1/16W J	L501	2007-000094	CHIP BEAD	500Ω
R617	2401-002594	C RESISTOR	100Ω 1/16W J	L502	2007-000094	CHIP BEAD	500Ω
R618	2401-002594	C RESISTOR	100Ω 1/16W J	L504	2007-000094	CHIP BEAD	500Ω
R619	T2203-FC100D	C RESISTOR	0Ω 1/16W J	L505	2007-000129	CHIP BEAD	500Ω
R620	T2203-FC100D	C RESISTOR	0Ω 1/16W J	L507	2007-000129	CHIP BEAD	500Ω
R621	T2203-FC220D	C RESISTOR	0Ω 1/16W J	L509	2007-000129	CHIP BEAD	500Ω
R622	T2203-FC220D	C RESISTOR	0Ω 1/16W J	L510	2007-000129	CHIP BEAD	500Ω
R623	T1001-00083A	C RESISTOR	10KΩ 1/16W J	L511	2007-000129	CHIP BEAD	500Ω
R624	T1001-00082A	C RESISTOR	20KΩ 1/16W J	L512	2007-000096	CHIP BEAD	500Ω
R625	T3711-00033	C RESISTOR	1KΩ 1/16W J	L513	2007-000096	CHIP BEAD	500Ω
R629	T2401-CT2210	C RESISTOR	100Ω 1/16W J	L514	2007-000096	CHIP BEAD	500Ω
R630	T1001-00082A	C RESISTOR	20KΩ 1/16W J	L515	2007-000096	CHIP BEAD	500Ω
R631	T1001-00083A	C RESISTOR	10KΩ 1/16W J	L516	2007-000096	CHIP BEAD	500Ω
R632	T2203-FC102D	C RESISTOR	10Ω 1/16W J	L517	2007-000097	CHIP BEAD	500Ω
R633	T3711-00037	C RESISTOR	4.7KΩ 1/16W J	L5VA	2007-000120	CHIP BEAD	80Ω
R701	T2401-CT2210	C RESISTOR	100Ω 1/16W J	L5VB	2007-000120	CHIP BEAD	80Ω
R702	T2401-CT2210	C RESISTOR	100Ω 1/16W J	L5VC	2007-000121	CHIP BEAD	80Ω
R703	T2401-CT2210	C RESISTOR	100Ω 1/16W J	L601	T2007-HC472J	CHIP COIL	10uH
R704	T2801-00013A	C RESISTOR	560Ω 1/16W J	L602	T2007-HC472J	CHIP COIL	10uH
R705	T2801-00012A	C RESISTOR	820Ω 1/16W J	L603	2007-000097	CHIP BEAD	500Ω
R707	T2203-FC103D	C RESISTOR	10Ω 1/16W J	L606	2007-000097	CHIP BEAD	500Ω
R708	T2401-CT2210	C RESISTOR	100Ω 1/16W J	L608	2007-000097	CHIP BEAD	500Ω
R709	T2203-FC103D	C RESISTOR	10Ω 1/16W J	L610	2007-000121	CHIP BEAD	80Ω
R710	T3711-00033	C RESISTOR	1KΩ 1/16W J	L701	2007-000109	CHIP COIL	10uH
R711	T2203-FC330D	C RESISTOR	0Ω 1/16W J				

△Ref No.	Part No.	Part Name	Description	Local	△Ref No.	Part No.	Part Name	Description	Local
L703	2007-000102	SMD COIL	680uH		CE626	T2203-FC100D	E CAPACITOR	1uF 50V M	
L705	2007-000100	SMD COIL	470uH		CE627	2007-000102	E CAPACITOR	47uF 16V M	
L801	2007-000118	CHIP BEAD	80Ω		CE630	T2007-HC472J	E CAPACITOR	22uF 16V M	
L802	2007-000118	CHIP BEAD	80Ω		CE701	2007-000100	E CAPACITOR	100uF 16V M	
L803	2007-000118	CHIP BEAD	80Ω		CE702	T2203-FC102D	E CAPACITOR	10uF 16V M	
L804	2007-000118	CHIP BEAD	80Ω		CE703	2007-000100	E CAPACITOR	100uF 16V M	
L805	2007-000118	CHIP BEAD	80Ω		CE704	2007-000100	E CAPACITOR	100uF 16V M	
L806	2007-000077	CHIP BEAD	80Ω		CE705	T2203-FC100D	E CAPACITOR	1uF 50V M	
L807	2007-000077	CHIP BEAD	80Ω		CE801	T2203-FC103D	E CAPACITOR	220uF 16V M	
L808	2007-000077	CHIP BEAD	80Ω		CE802	T2203-FC221E	E CAPACITOR	470uF 16V M	
L809	2007-000077	CHIP BEAD	80Ω		CE803	2007-000107	E CAPACITOR	47uF 16V M	
L810	2007-000077	CHIP BEAD	80Ω		CE804	2007-000100	E CAPACITOR	100uF 16V M	
L812	2007-000119	CHIP BEAD	80Ω		CE805	T2203-DC104E	E CAPACITOR	220uF 16V M	
L813	2007-000119	CHIP BEAD	80Ω		CE808	T2203-FC104D	E CAPACITOR	220uF 16V M	
L814	2007-000107	SMD COIL	100uH		CE809	T2203-FC224D	E CAPACITOR	1000uF 10V M	
L815	2007-000119	CHIP BEAD	80Ω		CE810	T2203-FC222D	E CAPACITOR	470uF 16V M	
L816	2007-000119	CHIP BEAD	80Ω		CE811	T2203-DC104E	E CAPACITOR	220uF 16V M	
L820	2007-000119	CHIP BEAD	80Ω		J101	2401-002594	CONNECTOR		
L821	2007-000120	CHIP BEAD	80Ω		J102	T2401-CT2210	CONNECTOR		
L822	2007-000120	CHIP BEAD	80Ω		J201	T2203-FC472D	JACK	PC IN	
L823	2007-000120	CHIP BEAD	80Ω		J202	T2203-FC473D	JACK	EXT2	
L830	T3711-00033	C RESISTOR	1KΩ 1/16W J		J203	T2203-FC682D	JACK	EXT-1	
LA01	2007-000121	CHIP BEAD	80Ω		J205	T2203-FC104E	JACK	EXT-3/EXT4	
LA02	2007-000121	CHIP BEAD	80Ω		J209	T2401-FT0R1A	CONNECTOR		
CE101	2007-000097	E CAPACITOR	100uF 16V M		J210	2401-000269	CONNECTOR		
CE102	2007-000107	E CAPACITOR	47uF 16V M		J303	T2203-BC106E	CONNECTOR		
CE103	2007-000109	E CAPACITOR	22uF 16V M		J304	2401-001495	CONNECTOR		
CE105	T2203-FC220D	E CAPACITOR	10uF 16V M		J501	2401-000603	CONNECTOR		
CE107	T2203-FC060D	E CAPACITOR	1uF 50V M		J601	T2401-CT4700	CONNECTOR		
CE108	2007-000096	E CAPACITOR	0.1uF 50V M		J602	2401-000914	CONNECTOR		
CE202	T2203-FC220D	E CAPACITOR	10uF 16V M		J801	2401-002235	CONNECTOR		
CE203	T2203-FC220D	E CAPACITOR	10uF 16V M		RN301	2007-000084	BEAD ARRAY	120Ω	
CE204	T2203-FC220D	E CAPACITOR	10uF 16V M		RN302	2007-000084	BEAD ARRAY	120Ω	
CE205	T2203-FC220D	E CAPACITOR	10uF 16V M		RN303	2007-000084	BEAD ARRAY	120Ω	
CE206	T2203-FC103D	E CAPACITOR	220uF 16V M		RN304	2007-000084	BEAD ARRAY	120Ω	
CE207	T2203-FC103D	E CAPACITOR	220uF 16V M		RN305	2007-000084	BEAD ARRAY	120Ω	
CE220	2007-000097	E CAPACITOR	100uF 16V M		RN306	2007-000090	BEAD ARRAY	120Ω	
CE221	2007-000097	E CAPACITOR	100uF 16V M		RN307	2007-000090	BEAD ARRAY	120Ω	
CE301	T2203-FC150D	E CAPACITOR	100uF 10V M		RN308	T1001-00079A	CHIP ARRAY	4.7KΩ 1/16W J	
CE302	T2203-CC105D	E CAPACITOR	100uF 10V M		RN309	2007-000090	BEAD ARRAY	120Ω	
CE402	2007-000109	E CAPACITOR	22uF 16V M		RN310	T1001-00079A	CHIP ARRAY	4.7KΩ 1/16W J	
CE404	T2203-FC330D	E CAPACITOR	10uF 16V M		RN408	2007-000078	BEAD ARRAY	30Ω	
CE405	T2203-FC330D	E CAPACITOR	10uF 16V M		RN409	2007-000078	BEAD ARRAY	30Ω	
CE407	T2203-FC330D	E CAPACITOR	10uF 16V M		RN410	2007-000078	BEAD ARRAY	30Ω	
CE408	T2203-FC330D	E CAPACITOR	10uF 16V M		RN411	2007-000078	BEAD ARRAY	30Ω	
CE410	T2203-FC221E	E CAPACITOR	470uF 16V M		RN412	T1001-00049A	CHIP ARRAY	33Ω 1/16W J	
CE411	T2203-FC152D	E CAPACITOR	4.7uF 50V M		RN413	T1001-00049A	CHIP ARRAY	33Ω 1/16W J	
CE412	T2203-FC330D	E CAPACITOR	10uF 16V M		RN414	T1001-00049A	CHIP ARRAY	33Ω 1/16W J	
CE413	T2203-FC470D	E CAPACITOR	10uF 16V M		RN415	T1001-00049A	CHIP ARRAY	33Ω 1/16W J	
CE414	T2203-FC152D	E CAPACITOR	4.7uF 50V M		RN416	T1001-00049A	CHIP ARRAY	33Ω 1/16W J	
CE415	T2203-FC470D	E CAPACITOR	10uF 16V M		RN417	T1001-00078A	CHIP ARRAY	33Ω 1/16W J	
CE416	T2203-FC152D	E CAPACITOR	4.7uF 50V M		RN418	T1001-00078A	CHIP ARRAY	33Ω 1/16W J	
CE502	T2203-FC104D	E CAPACITOR	220uF 16V M		RN503	2007-000081	BEAD ARRAY	30Ω	
CE503	2007-000097	E CAPACITOR	100uF 16V M		RN505	2007-000081	BEAD ARRAY	30Ω	
CE504	2007-000107	E CAPACITOR	47uF 16V M		RN508	2007-000081	BEAD ARRAY	30Ω	
CE506	2007-000109	E CAPACITOR	22uF 16V M		RN509	2007-000081	BEAD ARRAY	30Ω	
CE507	2007-000109	E CAPACITOR	22uF 16V M		RN510	2007-000082	BEAD ARRAY	30Ω	
CE508	2007-000102	E CAPACITOR	47uF 16V M		RN511	2007-000082	BEAD ARRAY	30Ω	
CE509	2007-000109	E CAPACITOR	22uF 16V M		RN512	2007-000082	BEAD ARRAY	30Ω	
CE510	T2007-HC330J	E CAPACITOR	22uF 16V M		RN513	2007-000078	BEAD ARRAY	30Ω	
CE511	T2007-HC330J	E CAPACITOR	22uF 16V M		RN514	2007-000082	BEAD ARRAY	30Ω	
CE512	T2007-HC330J	E CAPACITOR	22uF 16V M		RN515	2007-000123	BEAD ARRAY	30Ω	
CE513	T2007-HC330J	E CAPACITOR	22uF 16V M		RN516	2007-000123	BEAD ARRAY	30Ω	
CE514	T2007-HC330J	E CAPACITOR	22uF 16V M		RN517	2007-000123	BEAD ARRAY	30Ω	
CE515	T2007-HC472J	E CAPACITOR	22uF 16V M		RN518	2007-000123	BEAD ARRAY	30Ω	
CE516	T2007-HC472J	E CAPACITOR	22uF 16V M		RN519	2007-000123	BEAD ARRAY	30Ω	
CE517	T2203-FC470D	E CAPACITOR	10uF 16V M		RN520	2007-000081	BEAD ARRAY	30Ω	
CE518	2007-000097	E CAPACITOR	100uF 16V M		X301	T2203-FC331D	CRYSTAL	6MHz	
CE601	T2203-FC103D	E CAPACITOR	220uF 16V M		X401	T2203-FC392D	CRYSTAL	27MHz	
CE602	T2203-FC103D	E CAPACITOR	220uF 16V M		X501	T2203-FC332D	CRYSTAL	14.318MHz	
CE603	2007-000102	E CAPACITOR	47uF 16V M		X601	T2203-FC334D	CRYSTAL	18.432MHz	
CE604	2007-000102	E CAPACITOR	47uF 16V M						
CE605	T2203-FC060D	E CAPACITOR	1uF 50V M						
CE606	T2203-CC105D	E CAPACITOR	100uF 10V M						
CE607	T2203-FC470D	E CAPACITOR	10uF 16V M						
CE608	T2203-FC470D	E CAPACITOR	10uF 16V M						
CE609	T2203-FC101D	E CAPACITOR	10uF 16V M						
CE610	T2203-FC101D	E CAPACITOR	10uF 16V M						
CE611	T2203-FC101D	E CAPACITOR	10uF 16V M						
CE612	2007-000102	E CAPACITOR	47uF 16V M						
CE613	T2203-FC101D	E CAPACITOR	10uF 16V M						
CE614	T2203-FC101D	E CAPACITOR	10uF 16V M						
CE617	T2203-FC102D	E CAPACITOR	10uF 16V M						
CE620	T2203-FC102D	E CAPACITOR	10uF 16V M						
CE621	T2203-FC102D	E CAPACITOR	10uF 16V M						
CE622	T2203-FC060D	E CAPACITOR	1uF 50V M						
CE623	T2203-FC060D	E CAPACITOR	1uF 50V M						
CE624	T2203-FC102D	E CAPACITOR	10uF 16V M						
CE625	T2203-FC060D	E CAPACITOR	1uF 50V M						

POWER P.W. BOARD ASS'Y (QAL0826-001)

REFER TO PARTS LIST IN PAGE 3-10 FOR THIS P.W. BOARD.

LED P.W. BOARD ASS'Y (QAL0827-001)

REFER TO PARTS LIST IN PAGE 3-12 FOR THIS P.W. BOARD.

KEY P.W. BOARD ASS'Y (QAL0828-001)

REFER TO PARTS LIST IN PAGE 3-12 FOR THIS P.W. BOARD.

PRINTED WIRING BOARD PARTS LIST [LT-32A61BJ, LT-32A61BU, LT-32A61SU/c]

MAIN P.W. BOARD ASS'Y (QAL0825-001)

△Ref No.	Part No.	Part Name	Description	Local
U101	T1001-00081A	IC		
U202	ATF02-32A61BJ	IC	(SERVICE)	
U301	T1001-00073A-61	IC		
U302	T1001-00064A	IC		
U303	ATF32-32A61BJ	IC	(SERVICE)	
U401	T1001-00084A	IC		
U402	T1001-00085A	IC		
U405	T1001-00075A	IC		
U501	T1001-00086A	IC		
U502	T1001-00063A	IC		
U601	T1001-00087A	IC		
U602	T1001-00088A	IC		
U603	T1001-00070A	IC		
U801	T0407-00004A	TRANSISTOR		
U802	T0407-00004A	TRANSISTOR		
Q101	T1001-00052A	IC		
Q102	T0507-00001A	TRANSISTOR		
Q103	T0507-00001A	TRANSISTOR		
Q104	T0507-00001A	TRANSISTOR		
Q105	T0507-00006A	TRANSISTOR		
Q106	T0507-00001A	TRANSISTOR		
Q202	T0507-00001A	TRANSISTOR		
Q203	T0507-00005A	TRANSISTOR		
Q301	T1001-00049A	IC		
Q303	T1001-00078A	IC		
Q304	T0507-00003A	TRANSISTOR		
Q305	T0507-00003A	TRANSISTOR		
Q306	T0507-00007A	TRANSISTOR		
Q307	T0407-00003A	TRANSISTOR		
Q308	T0507-00005A	TRANSISTOR		
Q309	T0507-00005A	TRANSISTOR		
Q311	T0507-00005A	TRANSISTOR		
Q312	T0507-00006A	TRANSISTOR		
Q315	T0507-00006A	TRANSISTOR		
Q316	T0507-00005A	TRANSISTOR		
Q317	T0407-00003A	TRANSISTOR		
Q403	T0507-00006A	TRANSISTOR		
Q501	T1001-00079A	IC		
Q502	T1001-00048A	IC		
Q503	T0507-00007A	TRANSISTOR		
Q601	T0507-00006A	TRANSISTOR		
Q602	T0507-00002A	TRANSISTOR		
Q603	T0507-00002A	TRANSISTOR		
Q604	T0407-00002A	TRANSISTOR		
Q701	T0507-00002A	TRANSISTOR		
Q702	T0507-00002A	TRANSISTOR		
Q703	T0507-00002A	TRANSISTOR		
Q801	T1001-00089A	IC		
Q802	T0507-00008A	TRANSISTOR		
Q804	T1001-00051A	IC		
Q805	T0507-00008A	TRANSISTOR		
Q806	T0507-00008A	TRANSISTOR		
Q2203	T0407-00002A	TRANSISTOR		
D101	T0408-00002A	DIODE		
D205	T2703-IC002A	Z DIODE		
D206	T2703-IC002A	Z DIODE		
D207	T2703-IC002A	Z DIODE		
D208	T2703-IC002A	Z DIODE		
D209	T2703-IC002A	Z DIODE		
D210	T2703-IC002A	Z DIODE		
D222	2007-000070	DIODE		
D223	2007-000070	DIODE		
D224	2007-000070	DIODE		
D225	2007-000070	DIODE		
D226	2007-000070	DIODE		
D227	2007-000882	DIODE		
D228	2007-000882	DIODE		
D229	2007-000882	DIODE		
D301	T0408-00002A	DIODE		
D601	T0408-00002A	DIODE		
D602	T0408-00002A	DIODE		
D702	T0408-00002A	DIODE		
D704	T0408-00002A	DIODE		
D801	T0407-00005A	DIODE		
ZD101	T0408-00009A	Z DIODE		
ZD202	T0408-00009A	Z DIODE		
ZD203	T0408-00009A	Z DIODE		
ZD204	T0408-00009A	Z DIODE		
ZD206	T0408-00009A	Z DIODE		
ZD209	T2901-HC002A	Z DIODE		
ZD210	T2901-HC002A	Z DIODE		
ZD211	T2901-HC002A	Z DIODE		
ZD212	T2901-HC002A	Z DIODE		
ZD213	T2901-HC002A	Z DIODE		
ZD214	T2901-HC001A	Z DIODE		
ZD215	T2901-HC001A	Z DIODE		
ZD216	T2901-HC001A	Z DIODE		
ZD217	T2901-HC001A	Z DIODE		
ZD218	T2901-HC001A	Z DIODE		
ZD219	T2901-JC005A	Z DIODE		
ZD221	T2901-JC005A	Z DIODE		
ZD222	T2901-JC005A	Z DIODE		
ZD227	T2901-JC005A	Z DIODE		
ZD230	T2901-JC005A	Z DIODE		
ZD231	T2901-JC012B	Z DIODE		
ZD232	T2901-JC012B	Z DIODE		
ZD250	T2901-JC012B	Z DIODE		
ZD251	T2901-JC012B	Z DIODE		
ZD252	T2901-JC012B	Z DIODE		
ZD253	T2901-JC010B	Z DIODE		
ZD254	T2901-JC010B	Z DIODE		
ZD255	T2901-JC010B	Z DIODE		
ZD256	T2901-JC010B	Z DIODE		
ZD257	T2901-JC010B	Z DIODE		
ZD258	T2901-JC004A	Z DIODE		
ZD259	T2901-JC004A	Z DIODE		
ZD260	T2901-JC004A	Z DIODE		
ZD261	T2901-JC004A	Z DIODE		
ZD262	T2901-JC004A	Z DIODE		
ZD263	T2703-KC007A	Z DIODE		
ZD264	T2703-KC007A	Z DIODE		
ZD267	T2703-KC007A	Z DIODE		
ZD270	T2703-KC007A	Z DIODE		
ZD271	T2703-KC007A	Z DIODE		
ZD280	T2703-KC014A	Z DIODE		
ZD281	T2703-KC014A	Z DIODE		
ZD702	T2703-JC011A	DIODE		
ZD2213	T2703-KC014A	Z DIODE		
ZD2214	T2703-KC014A	Z DIODE		
ZD2215	T2703-KC014A	Z DIODE		
ZD2216	T2703-LC010A	Z DIODE		
ZD2274	T2703-LC010A	Z DIODE		
C101	T0407-00002A	C CAPACITOR		100nF 25V K
C103	2007-000094	C CAPACITOR		10uF 10V Z
C105	2007-000093	C CAPACITOR		100nF 50V Z
C106	2007-000094	C CAPACITOR		10uF 10V Z
C107	2007-000094	C CAPACITOR		10uF 10V Z
C109	2007-000094	C CAPACITOR		10uF 10V Z
C110	2007-000094	C CAPACITOR		10uF 10V Z
C113	2007-000129	C CAPACITOR		10uF 10V Z
C201	T0507-00005A	C CAPACITOR		1nF 50V K
C202	2007-000081	C CAPACITOR		47nF 50V K
C203	2007-000081	C CAPACITOR		47nF 50V K
C204	2007-000081	C CAPACITOR		47nF 50V K
C205	2007-000081	C CAPACITOR		47nF 50V K
C206	2007-000081	C CAPACITOR		47nF 50V K
C207	2007-000082	C CAPACITOR		47nF 50V K
C208	2007-000082	C CAPACITOR		47nF 50V K
C209	2007-000082	C CAPACITOR		47nF 50V K
C210	T0507-00005A	C CAPACITOR		1nF 50V K
C211	2007-000082	C CAPACITOR		47nF 50V K
C213	T1001-00089A	C CAPACITOR		10pF 50V K
C214	T1001-00089A	C CAPACITOR		10pF 50V K
C215	T1001-00089A	C CAPACITOR		10pF 50V K
C216	2007-000120	C CAPACITOR		0.47nF 50V K
C218	2007-000120	C CAPACITOR		0.47nF 50V K
C219	2007-000120	C CAPACITOR		0.47nF 50V K
C220	2007-000120	C CAPACITOR		0.47nF 50V K
C221	2007-000120	C CAPACITOR		0.47nF 50V K
C222	2007-000121	C CAPACITOR		0.47nF 50V K
C223	2007-000121	C CAPACITOR		0.47nF 50V K
C226	2007-000121	C CAPACITOR		0.47nF 50V K
C227	2007-000082	C CAPACITOR		47nF 50V K
C228	2007-000084	C CAPACITOR		47nF 50V K
C229	2007-000084	C CAPACITOR		47nF 50V K
C230	2007-000121	C CAPACITOR		0.47nF 50V K
C233	2007-000121	C CAPACITOR		0.47nF 50V K
C234	2007-000078	C CAPACITOR		0.47nF 50V K
C235	2007-000078	C CAPACITOR		0.47nF 50V K
C236	T1001-00089A	C CAPACITOR		10pF 50V K
C238	T1001-00089A	C CAPACITOR		10pF 50V K
C242	2007-000643	C CAPACITOR		0.33nF 50V K
C243	2007-000643	C CAPACITOR		0.33nF 50V K
C244	2007-000643	C CAPACITOR		0.33nF 50V K
C248	2007-000077	C CAPACITOR		330nF 16V Z
C249	2007-000077	C CAPACITOR		330nF 16V Z
C252	T0407-00002A	C CAPACITOR		100nF 25V K
C253	T0407-00002A	C CAPACITOR		100nF 25V K
C254	T0407-00002A	C CAPACITOR		100nF 25V K

△Ref No.	Part No.	Part Name	Description Local	△Ref No.	Part No.	Part Name	Description Local
C255	T0407-00002A	C CAPACITOR	100nF 25V K	C516	T2703-KC014A	C CAPACITOR	100nF 25V K
C256	T0407-00004A	C CAPACITOR	100nF 25V K	C517	T2703-LC010A	C CAPACITOR	100nF 25V K
C257	T0407-00004A	C CAPACITOR	100nF 25V K	C518	T2703-LC010A	C CAPACITOR	100nF 25V K
C258	T0407-00004A	C CAPACITOR	100nF 25V K	C519	T2703-LC010A	C CAPACITOR	100nF 25V K
C259	T0407-00004A	C CAPACITOR	100nF 25V K	C520	T2703-LC010A	C CAPACITOR	100nF 25V K
C301	T0407-00004A	C CAPACITOR	100nF 25V K	C524	T2703-LC010A	C CAPACITOR	100nF 25V K
C302	T0407-00003A	C CAPACITOR	100nF 25V K	C525	T2703-IC002A	C CAPACITOR	100nF 25V K
C303	T0407-00003A	C CAPACITOR	100nF 25V K	C526	T2703-IC002A	C CAPACITOR	100nF 25V K
C304	T0407-00003A	C CAPACITOR	100nF 25V K	C527	T2703-IC002A	C CAPACITOR	100nF 25V K
C305	T0407-00003A	C CAPACITOR	100nF 25V K	C528	T2703-IC002A	C CAPACITOR	100nF 25V K
C306	2007-000074	C CAPACITOR	0.22nF 50V K	C529	T2703-IC002A	C CAPACITOR	100nF 25V K
C307	T0507-00002A	C CAPACITOR	10nF 50V K	C530	T2703-IC002A	C CAPACITOR	100nF 25V K
C308	2007-000075	C CAPACITOR	220nF 50V K	C531	T2703-IC002A	C CAPACITOR	100nF 25V K
C309	T0407-00003A	C CAPACITOR	100nF 25V K	C532	T2703-IC002A	C CAPACITOR	100nF 25V K
C310	T0408-00002A	C CAPACITOR	100nF 25V K	C533	T2703-IC002A	C CAPACITOR	100nF 25V K
C311	T0507-00007A	C CAPACITOR	33pF 50V K	C534	T2703-IC002A	C CAPACITOR	100nF 25V K
C312	T0507-00001A	C CAPACITOR	0.1nF 50V K	C535	T2703-JC011A	C CAPACITOR	100nF 25V K
C313	T0507-00001A	C CAPACITOR	0.1nF 50V K	C536	T2703-JC011A	C CAPACITOR	100nF 25V K
C314	T0507-00001A	C CAPACITOR	0.1nF 50V K	C537	T2703-JC011A	C CAPACITOR	100nF 25V K
C316	T0507-00007A	C CAPACITOR	0.1nF 50V K	C538	T2703-JC011A	C CAPACITOR	100nF 25V K
C317	T0408-00002A	C CAPACITOR	100nF 25V K	C539	T2703-JC011A	C CAPACITOR	100nF 25V K
C318	T0408-00002A	C CAPACITOR	100nF 25V K	C540	2007-000070	C CAPACITOR	100nF 25V K
C319	T0408-00002A	C CAPACITOR	100nF 25V K	C541	2007-000070	C CAPACITOR	100nF 25V K
C402	T0408-00002A	C CAPACITOR	100nF 25V K	C543	2007-000070	C CAPACITOR	100nF 25V K
C403	T0408-00002A	C CAPACITOR	100nF 25V K	C544	2007-000070	C CAPACITOR	100nF 25V K
C404	T0408-00002A	C CAPACITOR	100nF 25V K	C545	2007-000070	C CAPACITOR	100nF 25V K
C405	T0408-00002A	C CAPACITOR	100nF 25V K	C546	2007-000882	C CAPACITOR	100nF 25V K
C406	T0408-00002A	C CAPACITOR	100nF 25V K	C548	2007-000882	C CAPACITOR	100nF 25V K
C407	T0408-00002A	C CAPACITOR	100nF 25V K	C549	2007-000882	C CAPACITOR	100nF 25V K
C409	T0407-00005A	C CAPACITOR	100nF 25V K	C550	T1001-00051A	C CAPACITOR	10pF 50V K
C411	T0407-00005A	C CAPACITOR	100nF 25V K	C552	2007-000882	C CAPACITOR	100nF 25V K
C412	T0407-00005A	C CAPACITOR	100nF 25V K	C553	T0507-00007A	C CAPACITOR	33pF 50V K
C413	T0407-00005A	C CAPACITOR	100nF 25V K	C554	T0507-00007A	C CAPACITOR	33pF 50V K
C414	T0407-00005A	C CAPACITOR	100nF 25V K	C555	2007-000882	C CAPACITOR	100nF 25V K
C415	T0408-000009A	C CAPACITOR	100nF 25V K	C556	T0507-00005A	C CAPACITOR	1nF 50V K
C416	T0408-000009A	C CAPACITOR	100nF 25V K	C557	T1001-00051A	C CAPACITOR	10pF 50V K
C417	T0408-000009A	C CAPACITOR	100nF 25V K	C559	2007-001134	C CAPACITOR	1uF 16V Z
C419	T0408-000009A	C CAPACITOR	100nF 25V K	C601	2007-000309	C CAPACITOR	100nF 25V K
C420	T0408-000009A	C CAPACITOR	100nF 25V K	C604	2007-000118	C CAPACITOR	3.3nF 50V K
C421	2007-000115	C CAPACITOR	1.5nF 50V K	C605	2007-000118	C CAPACITOR	3.3nF 50V K
C422	2007-000115	C CAPACITOR	1.5nF 50V K	C606	T1001-00048A	C CAPACITOR	6pF 50V K
C423	2007-000115	C CAPACITOR	1.5nF 50V K	C607	T1001-00048A	C CAPACITOR	6pF 50V K
C424	T0507-00001A	C CAPACITOR	0.1nF 50V K	C608	T0507-00006A	C CAPACITOR	47pF 50V K
C425	T0507-00003A	C CAPACITOR	22pF 50V K	C610	2007-000309	C CAPACITOR	100nF 25V K
C426	T0507-00003A	C CAPACITOR	22pF 50V K	C611	T0507-00006A	C CAPACITOR	47pF 50V K
C427	T2901-HC002A	C CAPACITOR	100nF 25V K	C612	T2203-FC100D	C RESISTOR	0Ω 1/16W J
C428	T2901-HC002A	C CAPACITOR	100nF 25V K	C614	2007-000123	C CAPACITOR	4.7nF 50V K
C429	T2901-HC002A	C CAPACITOR	100nF 25V K	C615	2007-000643	C CAPACITOR	0.33nF 50V K
C430	T2901-HC002A	C CAPACITOR	100nF 25V K	C616	2007-000643	C CAPACITOR	0.33nF 50V K
C431	T2901-HC002A	C CAPACITOR	100nF 25V K	C617	2007-000309	C CAPACITOR	100nF 25V K
C432	T2901-HC011A	C CAPACITOR	100nF 25V K	C618	T0507-00002A	C CAPACITOR	10nF 50V K
C433	T2901-HC011A	C CAPACITOR	100nF 25V K	C619	T0507-00002A	C CAPACITOR	10nF 50V K
C434	T2901-HC011A	C CAPACITOR	100nF 25V K	C620	T0507-00002A	C CAPACITOR	10nF 50V K
C435	T2901-HC011A	C CAPACITOR	100nF 25V K	C621	2007-000309	C CAPACITOR	100nF 25V K
C436	T1001-00051A	C CAPACITOR	10pF 50V K	C623	2007-000119	C CAPACITOR	3.9nF 50V K
C438	T2901-HC011A	C CAPACITOR	100nF 25V K	C624	2007-000119	C CAPACITOR	3.9nF 50V K
C439	T2901-JC005A	C CAPACITOR	100nF 25V K	C625	T0507-00005A	C CAPACITOR	1nF 50V K
C440	T2901-JC005A	C CAPACITOR	100nF 25V K	C626	2007-000076	C CAPACITOR	0.33nF 50V K
C441	T2901-JC005A	C CAPACITOR	100nF 25V K	C627	2007-000076	C CAPACITOR	0.33nF 50V K
C442	T2901-JC005A	C CAPACITOR	100nF 25V K	C632	2007-000076	C CAPACITOR	0.33nF 50V K
C443	T2901-JC005A	C CAPACITOR	100nF 25V K	C633	2007-000076	C CAPACITOR	0.33nF 50V K
C444	T2901-JC012B	C CAPACITOR	100nF 25V K	C634	2007-001134	C CAPACITOR	1uF 16V Z
C445	T2901-JC012B	C CAPACITOR	100nF 25V K	C635	2007-001134	C CAPACITOR	1uF 16V Z
C446	T2901-JC012B	C CAPACITOR	100nF 25V K	C636	T0507-00006A	C CAPACITOR	47pF 50V K
C447	T2901-JC012B	C CAPACITOR	100nF 25V K	C638	2007-000309	C CAPACITOR	100nF 25V K
C451	T0507-00002A	C CAPACITOR	10nF 50V K	C639	2007-000090	C CAPACITOR	6.8nF 50V K
C452	T2901-JC012B	C CAPACITOR	100nF 25V K	C640	2007-000090	C CAPACITOR	6.8nF 50V K
C453	T2901-JC010B	C CAPACITOR	100nF 25V K	C701	2007-000071	C CAPACITOR	100nF 25V K
C454	T2901-JC010B	C CAPACITOR	100nF 25V K	C702	2007-000071	C CAPACITOR	100nF 25V K
C455	2007-000078	C CAPACITOR	0.47nF 50V K	C703	T0507-00008A	C CAPACITOR	10nF 50V K
C456	T2901-JC010B	C CAPACITOR	100nF 25V K	C707	2007-000072	C CAPACITOR	100nF 50V K
C457	T2901-JC010B	C CAPACITOR	100nF 25V K	C710	2007-000084	C CAPACITOR	47nF 50V K
C458	T2901-JC010B	C CAPACITOR	100nF 25V K	C712	2007-001167	C CAPACITOR	0.15nF 50V K
C459	2007-001167	C CAPACITOR	0.15nF 50V K	C714	2007-000402	C CAPACITOR	2.2nF 50V K
C460	2007-001167	C CAPACITOR	0.15nF 50V K	C715	T0507-00005A	C CAPACITOR	1nF 50V K
C461	2007-000115	C CAPACITOR	1.5nF 50V K	C801	2007-000071	C CAPACITOR	100nF 25V K
C501	T2901-JC004A	C CAPACITOR	100nF 25V K	C802	2007-000071	C CAPACITOR	100nF 25V K
C502	T2901-JC004A	C CAPACITOR	100nF 25V K	C805	2007-000071	C CAPACITOR	100nF 25V K
C503	T2901-JC004A	C CAPACITOR	100nF 25V K	C806	2007-000113	C CAPACITOR	100nF 25V K
C504	T2901-JC004A	C CAPACITOR	100nF 25V K	C807	2007-000113	C CAPACITOR	100nF 25V K
C506	T2901-JC004A	C CAPACITOR	100nF 25V K	C820	2007-000113	C CAPACITOR	100nF 25V K
C507	T2703-KC007A	C CAPACITOR	100nF 25V K	C821	2007-000113	C CAPACITOR	100nF 25V K
C508	T2703-KC007A	C CAPACITOR	100nF 25V K	C2251	2007-000113	C CAPACITOR	100nF 25V K
C509	T2703-KC007A	C CAPACITOR	100nF 25V K	CA02	T0507-00006A	C CAPACITOR	47pF 50V K
C510	T2703-KC007A	C CAPACITOR	100nF 25V K	CA03	T0507-00006A	C CAPACITOR	47pF 50V K
C511	T2703-KC007A	C CAPACITOR	100nF 25V K				
C512	T2703-KC014A	C CAPACITOR	100nF 25V K	L301	T3711-00037	C RESISTOR	4.7KΩ 1/16W J
C513	T2703-KC014A	C CAPACITOR	100nF 25V K	R101	2401-001363	C RESISTOR	330Ω 1/16W J
C514	T2703-KC014A	C CAPACITOR	100nF 25V K	R102	2401-001363	C RESISTOR	330Ω 1/16W J
C515	T2703-KC014A	C CAPACITOR	100nF 25V K	R104	2401-001363	C RESISTOR	330Ω 1/16W J

△Ref No.	Part No.	Part Name	Description Local	△Ref No.	Part No.	Part Name	Description Local
R107	T2401-BT1010	C RESISTOR	220Ω 1/16W J	R310	T1001-00064A	C RESISTOR	10KΩ 1/16W J
R108	T2203-FC060D	C RESISTOR	0Ω 1/16W J	R313	2401-001495	C RESISTOR	100Ω 1/16W J
R109	T1001-00087A	C RESISTOR	100KΩ 1/16W J	R314	T3711-00037	C RESISTOR	4.7KΩ 1/16W J
R110	T1001-00087A	C RESISTOR	100KΩ 1/16W J	R315	T2203-FC101D	C RESISTOR	10Ω 1/16W J
R114	T1001-00087A	C RESISTOR	100KΩ 1/16W J	R316	T2203-FC101D	C RESISTOR	10Ω 1/16W J
R115	2401-001363	C RESISTOR	330Ω 1/16W J	R317	T2203-FC101D	C RESISTOR	10Ω 1/16W J
R119	2401-001363	C RESISTOR	330Ω 1/16W J	R318	T3711-00035	C RESISTOR	2.7KΩ 1/16W J
R121	T1001-00087A	C RESISTOR	100KΩ 1/16W J	R319	T2203-FC101D	C RESISTOR	10Ω 1/16W J
R123	T2401-CT4710	C RESISTOR	330Ω 1/16W J	R320	2401-001495	C RESISTOR	100Ω 1/16W J
R124	T2401-BT1010	C RESISTOR	220Ω 1/16W J	R321	T3711-00035	C RESISTOR	2.7KΩ 1/16W J
R126	TA40-00016A	C RESISTOR	1KΩ 1/16W J	R322	2401-001495	C RESISTOR	100Ω 1/16W J
R127	T1001-00073A	C RESISTOR	10KΩ 1/16W J	R327	2401-001495	C RESISTOR	100Ω 1/16W J
R128	T1001-00073A	C RESISTOR	10KΩ 1/16W J	R328	T2401-CT4700	C RESISTOR	100Ω 1/16W J
R129	T1001-00073A	C RESISTOR	10KΩ 1/16W J	R329	T2203-FC473D	C RESISTOR	75Ω 1/16W J
R130	TA40-00016A	C RESISTOR	1KΩ 1/16W J	R330	T3711-00037	C RESISTOR	4.7KΩ 1/16W J
R131	T3711-00034	C RESISTOR	1.5KΩ 1/16W J	R331	T2401-CT4700	C RESISTOR	100Ω 1/16W J
R132	T1001-00086A	C RESISTOR	47KΩ 1/16W J	R332	T2203-DC104E	C RESISTOR	22Ω 1/16W J
R133	T2401-BT1010	C RESISTOR	220Ω 1/16W J	R333	T2203-DC104E	C RESISTOR	22Ω 1/16W J
R134	T1001-00073A	C RESISTOR	10KΩ 1/16W J	R335	T1001-00084A	C RESISTOR	22KΩ 1/16W J
R136	T1001-00085A	C RESISTOR	27KΩ 1/16W J	R336	T1001-00086A	C RESISTOR	47KΩ 1/16W J
R138	T1001-00073A	C RESISTOR	10KΩ 1/16W J	R337	T3711-00036	C RESISTOR	3.3KΩ 1/16W J
R210	2401-002075	C RESISTOR	270Ω 1/16W J	R338	T3711-00036	C RESISTOR	3.3KΩ 1/16W J
R211	T2401-FT0R1A	C RESISTOR	100Ω 1/16W J	R339	T3711-00036	C RESISTOR	3.3KΩ 1/16W J
R214	TA40-00016A	C RESISTOR	1KΩ 1/16W J	R340	T2203-DC104E	C RESISTOR	22Ω 1/16W J
R215	TA40-00016A	C RESISTOR	1KΩ 1/16W J	R341	T2401-CT4700	C RESISTOR	100Ω 1/16W J
R216	TA40-00016A	C RESISTOR	1KΩ 1/16W J	R342	T2203-FC101D	C RESISTOR	10Ω 1/16W J
R217	T3722-00054A	C RESISTOR	1KΩ 1/16W J	R343	T3722-00040A	C RESISTOR	1KΩ 1/16W J
R218	T3722-00054A	C RESISTOR	1KΩ 1/16W J	R344	T2401-CT4700	C RESISTOR	100Ω 1/16W J
R219	T3722-00054A	C RESISTOR	1KΩ 1/16W J	R345	T2401-CT4700	C RESISTOR	100Ω 1/16W J
R220	T3722-00054A	C RESISTOR	1KΩ 1/16W J	R346	2401-000914	C RESISTOR	100Ω 1/16W J
R223	T2801-00011A	C RESISTOR	470Ω 1/16W J	R347	2401-000914	C RESISTOR	100Ω 1/16W J
R224	T2203-FC152D	C RESISTOR	33Ω 1/16W J	R348	2401-000914	C RESISTOR	100Ω 1/16W J
R225	T2203-FC392D	C RESISTOR	75Ω 1/16W J	R349	T3711-00037	C RESISTOR	4.7KΩ 1/16W J
R226	T2203-FC152D	C RESISTOR	33Ω 1/16W J	R350	T3711-00037	C RESISTOR	4.7KΩ 1/16W J
R227	T2203-FC392D	C RESISTOR	75Ω 1/16W J	R351	T2203-FC221E	C RESISTOR	33Ω 1/16W J
R228	T2203-FC152D	C RESISTOR	33Ω 1/16W J	R352	T2203-FC221E	C RESISTOR	33Ω 1/16W J
R229	T2203-FC392D	C RESISTOR	75Ω 1/16W J	R353	T2203-FC221E	C RESISTOR	33Ω 1/16W J
R230	T2203-FC152D	C RESISTOR	33Ω 1/16W J	R354	T2203-FC222D	C RESISTOR	33Ω 1/16W J
R231	T2203-FC152D	C RESISTOR	33Ω 1/16W J	R355	2401-000914	C RESISTOR	100Ω 1/16W J
R232	T2801-00011A	C RESISTOR	470Ω 1/16W J	R356	2401-000914	C RESISTOR	100Ω 1/16W J
R233	T2203-FC221E	C RESISTOR	33Ω 1/16W J	R357	T3711-00036	C RESISTOR	3.3KΩ 1/16W J
R235	T2203-FC392D	C RESISTOR	75Ω 1/16W J	R358	2401-000603	C RESISTOR	100Ω 1/16W J
R236	T2203-FC392D	C RESISTOR	75Ω 1/16W J	R359	2401-000603	C RESISTOR	100Ω 1/16W J
R237	T2203-FC104E	C RESISTOR	82Ω 1/16W J	R360	T3711-00036	C RESISTOR	3.3KΩ 1/16W J
R238	T2203-FC104E	C RESISTOR	82Ω 1/16W J	R361	T3711-00019	C RESISTOR	4.7KΩ 1/16W J
R239	T2203-FC104E	C RESISTOR	82Ω 1/16W J	R363	T2801-00014A	C RESISTOR	680Ω 1/16W J
R242	T2203-FC471D	C RESISTOR	75Ω 1/16W J	R364	T2203-FC102D	C RESISTOR	10Ω 1/16W J
R243	T3722-00054A	C RESISTOR	1KΩ 1/16W J	R365	T3711-00019	C RESISTOR	4.7KΩ 1/16W J
R244	T3722-00040A	C RESISTOR	1KΩ 1/16W J	R367	2401-000603	C RESISTOR	100Ω 1/16W J
R245	T2203-FC471D	C RESISTOR	75Ω 1/16W J	R370	T1001-00064A	C RESISTOR	10KΩ 1/16W J
R246	T2203-FC471D	C RESISTOR	75Ω 1/16W J	R371	T2401-CT4710	C RESISTOR	330Ω 1/16W J
R247	T2203-FC471D	C RESISTOR	75Ω 1/16W J	R373	2401-000603	C RESISTOR	100Ω 1/16W J
R248	T1001-00064A	C RESISTOR	10KΩ 1/16W J	R375	T1001-00064A	C RESISTOR	10KΩ 1/16W J
R249	T1001-00064A	C RESISTOR	10KΩ 1/16W J	R376	2401-002075	C RESISTOR	270Ω 1/16W J
R255	T2401-FT0R1A	C RESISTOR	100Ω 1/16W J	R377	T2203-FC060D	C RESISTOR	0Ω 1/16W J
R256	T2203-FC471D	C RESISTOR	75Ω 1/16W J	R378	T3722-00040A	C RESISTOR	1KΩ 1/16W J
R260	T2203-FC472D	C RESISTOR	75Ω 1/16W J	R380	T1001-00083A	C RESISTOR	10KΩ 1/16W J
R261	T1001-00085A	C RESISTOR	27KΩ 1/16W J	R382	2401-000603	C RESISTOR	100Ω 1/16W J
R262	T2203-FC472D	C RESISTOR	75Ω 1/16W J	R383	T2801-00013A	C RESISTOR	560Ω 1/16W J
R263	T2203-FC472D	C RESISTOR	75Ω 1/16W J	R385	2401-002235	C RESISTOR	100Ω 1/16W J
R264	T2203-FC472D	C RESISTOR	75Ω 1/16W J	R390	T3711-00019	C RESISTOR	4.7KΩ 1/16W J
R267	T2203-FC472D	C RESISTOR	75Ω 1/16W J	R391	T2203-FC060D	C RESISTOR	0Ω 1/16W J
R271	T2401-FT0R1A	C RESISTOR	100Ω 1/16W J	R392	T3711-00019	C RESISTOR	4.7KΩ 1/16W J
R272	T2401-FT0R1A	C RESISTOR	100Ω 1/16W J	R393	2401-002235	C RESISTOR	100Ω 1/16W J
R273	2401-002075	C RESISTOR	270Ω 1/16W J	R394	T3722-00040A	C RESISTOR	1KΩ 1/16W J
R274	T2401-FT0R1A	C RESISTOR	100Ω 1/16W J	R395	T2203-FC330D	C RESISTOR	0Ω 1/16W J
R275	T2203-FC060D	C RESISTOR	0Ω 1/16W J	R396	T3711-00029	C RESISTOR	3.3KΩ 1/16W J
R277	T2203-FC060D	C RESISTOR	0Ω 1/16W J	R397	T3711-00029	C RESISTOR	3.3KΩ 1/16W J
R278	T3722-00040A	C RESISTOR	1KΩ 1/16W J	R411	T2801-00011A	C RESISTOR	470Ω 1/16W J
R279	T3722-00040A	C RESISTOR	1KΩ 1/16W J	R412	T2203-FC334D	C RESISTOR	68Ω 1/16W J
R280	T3722-00040A	C RESISTOR	1KΩ 1/16W J	R413	2401-002235	C RESISTOR	100Ω 1/16W J
R281	T2203-FC104E	C RESISTOR	82Ω 1/16W J	R414	T2203-FC222D	C RESISTOR	33Ω 1/16W J
R282	T2203-FC104E	C RESISTOR	82Ω 1/16W J	R415	T2801-00014A	C RESISTOR	680Ω 1/16W J
R283	T2203-BC106E	C RESISTOR	82Ω 1/16W J	R416	T2203-DC104E	C RESISTOR	22Ω 1/16W J
R285	T2203-FC473D	C RESISTOR	75Ω 1/16W J	R417	T2203-DC104E	C RESISTOR	22Ω 1/16W J
R286	T1001-00085A	C RESISTOR	27KΩ 1/16W J	R418	T3711-00019	C RESISTOR	4.7KΩ 1/16W J
R287	T2203-FC470D	C RESISTOR	4.7Ω 1/16W J	R419	T2203-FC100D	C RESISTOR	0Ω 1/16W J
R288	T2203-FC473D	C RESISTOR	75Ω 1/16W J	R427	T1001-00052A	C RESISTOR	1MΩ 1/16W J
R289	T2203-FC473D	C RESISTOR	75Ω 1/16W J	R429	T2203-FC222D	C RESISTOR	33Ω 1/16W J
R290	2401-000269	C RESISTOR	100Ω 1/16W J	R432	T2203-FC222D	C RESISTOR	33Ω 1/16W J
R291	2401-000269	C RESISTOR	100Ω 1/16W J	R434	T2203-FC222D	C RESISTOR	33Ω 1/16W J
R292	T3722-00040A	C RESISTOR	1KΩ 1/16W J	R436	T2203-FC224D	C RESISTOR	33Ω 1/16W J
R294	T2203-FC470D	C RESISTOR	4.7Ω 1/16W J	R442	T2203-FC331D	C RESISTOR	33Ω 1/16W J
R295	T2203-FC473D	C RESISTOR	75Ω 1/16W J	R456	T3711-00038	C RESISTOR	4.7KΩ 1/16W J
R296	T3722-00040A	C RESISTOR	1KΩ 1/16W J	R457	T2203-FC682D	C RESISTOR	75Ω 1/16W J
R299	T2203-FC221E	C RESISTOR	33Ω 1/16W J	R458	T2203-FC682D	C RESISTOR	75Ω 1/16W J
R304	2401-000269	C RESISTOR	100Ω 1/16W J	R459	T2203-FC682D	C RESISTOR	75Ω 1/16W J
R305	2401-000269	C RESISTOR	100Ω 1/16W J	R460	T3711-00038	C RESISTOR	4.7KΩ 1/16W J
R307	2401-000269	C RESISTOR	100Ω 1/16W J	R461	T1001-00070A	C RESISTOR	470KΩ 1/16W J
R308	2401-001495	C RESISTOR	100Ω 1/16W J	R462	T3711-00038	C RESISTOR	4.7KΩ 1/16W J

△Ref No.	Part No.	Part Name	Description Local	△Ref No.	Part No.	Part Name	Description Local
R501	T1001-00083A	C RESISTOR	10KΩ 1/16W J	R712	T1001-00088A	C RESISTOR	100KΩ 1/16W J
R504	T3711-00038	C RESISTOR	4.7KΩ 1/16W J	R713	T1001-00084A	C RESISTOR	22KΩ 1/16W J
R505	T1001-00087A	C RESISTOR	100KΩ 1/16W J	R801	T1001-00083A	C RESISTOR	10KΩ 1/16W J
R509	2007-001167	CHIP BEAD	30Ω	R802	T3711-00037	C RESISTOR	4.7KΩ 1/16W J
R510	2007-001167	CHIP BEAD	30Ω	R803	2401-002075	C RESISTOR	270Ω 1/16W J
R511	2007-001167	CHIP BEAD	30Ω	R804	AA60-40014A	C RESISTOR	4.7KΩ 1/16W J
R515	2007-001167	CHIP BEAD	30Ω	R805	AA60-40014A	C RESISTOR	4.7KΩ 1/16W J
R516	2007-001167	CHIP BEAD	30Ω	R806	AA60-40014A	C RESISTOR	4.7KΩ 1/16W J
R517	2007-000115	CHIP BEAD	30Ω	R810	T2203-FC220D	C RESISTOR	0Ω 1/16W J
R518	2007-000115	CHIP BEAD	30Ω	R2215	T2203-FC332D	C RESISTOR	47Ω 1/16W J
R519	2007-000115	CHIP BEAD	30Ω	R2219	T2203-FC104D	C RESISTOR	22Ω 1/16W J
R529	T2203-FC100D	C RESISTOR	0Ω 1/16W J	R2220	T2203-FC104D	C RESISTOR	22Ω 1/16W J
R540	T2203-FC102D	C RESISTOR	10Ω 1/16W J	R2221	T2203-FC104D	C RESISTOR	22Ω 1/16W J
R541	2007-000115	CHIP BEAD	30Ω	R2222	T2203-FC104D	C RESISTOR	22Ω 1/16W J
R542	2007-000115	CHIP BEAD	30Ω	R2223	T2203-CC105D	C RESISTOR	22Ω 1/16W J
R543	2007-000074	CHIP BEAD	30Ω	R2224	T2203-CC105D	C RESISTOR	22Ω 1/16W J
R544	T2203-FC104D	C RESISTOR	22Ω 1/16W J	R2225	T2203-CC105D	C RESISTOR	22Ω 1/16W J
R546	2007-000074	CHIP BEAD	30Ω	R2226	T2203-CC105D	C RESISTOR	22Ω 1/16W J
R548	2007-000074	CHIP BEAD	30Ω	R2227	T2203-CC105D	C RESISTOR	22Ω 1/16W J
R550	2007-000074	CHIP BEAD	30Ω	R2228	T2203-FC150D	C RESISTOR	22Ω 1/16W J
R560	2007-000074	CHIP BEAD	30Ω	R2290	T3711-00033	C RESISTOR	1KΩ 1/16W J
R561	2007-000402	CHIP BEAD	30Ω	R2291	AA60-40014A	C RESISTOR	4.7KΩ 1/16W J
R562	2007-000402	CHIP BEAD	30Ω	R2292	AA60-40014A	C RESISTOR	4.7KΩ 1/16W J
R563	2007-000402	CHIP BEAD	30Ω	R2293	T1001-00081A	C RESISTOR	4.7KΩ 1/16W J
R565	2007-000402	CHIP BEAD	30Ω	RA01	T2203-FC220D	C RESISTOR	0Ω 1/16W J
R566	T2203-FC102D	C RESISTOR	10Ω 1/16W J	RA02	T2203-FC330D	C RESISTOR	0Ω 1/16W J
R567	2007-000402	CHIP BEAD	30Ω	RA03	T2203-FC331D	C RESISTOR	33Ω 1/16W J
R568	T2203-FC102D	C RESISTOR	10Ω 1/16W J	RA04	T2203-FC224D	C RESISTOR	33Ω 1/16W J
R571	T2203-FC334D	C RESISTOR	68Ω 1/16W J	RA05	T2203-FC224D	C RESISTOR	33Ω 1/16W J
R572	T2203-FC334D	C RESISTOR	68Ω 1/16W J	RA06	T2203-FC224D	C RESISTOR	33Ω 1/16W J
R573	T2203-FC334D	C RESISTOR	68Ω 1/16W J	RA07	T2203-FC224D	C RESISTOR	33Ω 1/16W J
R574	2401-002235	C RESISTOR	100Ω 1/16W J	RA08	T2203-FC331D	C RESISTOR	33Ω 1/16W J
R575	T2203-FC334D	C RESISTOR	68Ω 1/16W J	RA09	T2203-FC331D	C RESISTOR	33Ω 1/16W J
R577	2007-000075	CHIP BEAD	30Ω	RA10	T2203-FC331D	C RESISTOR	33Ω 1/16W J
R579	2007-000075	CHIP BEAD	30Ω	L201	2007-000309	CHIP BEAD	80Ω
R582	2007-000075	CHIP BEAD	30Ω	L202	2007-000309	CHIP BEAD	80Ω
R583	2007-000075	CHIP BEAD	30Ω	L203	2007-000309	CHIP BEAD	80Ω
R584	2007-000075	CHIP BEAD	30Ω	L204	2007-000309	CHIP BEAD	80Ω
R585	2007-000643	CHIP BEAD	30Ω	L205	2007-000309	CHIP BEAD	80Ω
R586	2007-000643	CHIP BEAD	30Ω	L206	2007-000071	CHIP BEAD	80Ω
R587	2007-000643	CHIP BEAD	30Ω	L207	2007-000071	CHIP BEAD	80Ω
R588	2007-000643	CHIP BEAD	30Ω	L208	2007-000071	CHIP BEAD	80Ω
R589	T2203-FC220D	C RESISTOR	0Ω 1/16W J	L209	2007-000071	CHIP BEAD	80Ω
R591	2007-000643	CHIP BEAD	30Ω	L210	2007-000071	CHIP BEAD	80Ω
R592	2007-000076	CHIP BEAD	30Ω	L211	2007-000113	CHIP BEAD	80Ω
R593	T3722-00040A	C RESISTOR	1KΩ 1/16W J	L212	2007-000113	CHIP BEAD	80Ω
R594	T3722-00041A	C RESISTOR	1KΩ 1/16W J	L213	2007-000113	CHIP BEAD	80Ω
R595	T3711-00038	C RESISTOR	4.7KΩ 1/16W J	L214	2007-000113	CHIP BEAD	80Ω
R596	T3711-00037	C RESISTOR	4.7KΩ 1/16W J	L215	2007-000113	CHIP BEAD	80Ω
R597	T2401-BT102A	C RESISTOR	390Ω 1/16W J	L216	2007-000113	CHIP BEAD	80Ω
R601	T3722-00041A	C RESISTOR	1KΩ 1/16W J	L217	2007-000113	CHIP BEAD	80Ω
R602	T1001-00063A	C RESISTOR	68KΩ 1/16W J	L218	2007-000072	CHIP BEAD	80Ω
R603	2401-000242	C RESISTOR	100Ω 1/16W J	L219	2007-000072	CHIP BEAD	80Ω
R604	T3711-00037	C RESISTOR	4.7KΩ 1/16W J	L220	2007-000072	CHIP BEAD	80Ω
R605	T3722-00041A	C RESISTOR	1KΩ 1/16W J	L221	2007-000072	CHIP BEAD	80Ω
R606	T1001-00086A	C RESISTOR	47KΩ 1/16W J	L302	2007-000072	CHIP BEAD	80Ω
R607	T3711-00037	C RESISTOR	4.7KΩ 1/16W J	L303	2007-001134	CHIP BEAD	80Ω
R608	T1001-00075A	C RESISTOR	30KΩ 1/16W J	L304	2007-001134	CHIP BEAD	80Ω
R609	T3722-00041A	C RESISTOR	1KΩ 1/16W J	L305	2007-001134	CHIP BEAD	80Ω
R610	T1001-00075A	C RESISTOR	30KΩ 1/16W J	L306	2007-000093	CHIP BEAD	500Ω
R611	T3722-00041A	C RESISTOR	1KΩ 1/16W J	L317	T2007-HC330J	CHIP COIL	10uH
R612	T1001-00086A	C RESISTOR	47KΩ 1/16W J	L401	2007-000093	CHIP BEAD	500Ω
R613	2401-002235	C RESISTOR	100Ω 1/16W J	L402	2007-000093	CHIP BEAD	500Ω
R614	2401-002594	C RESISTOR	100Ω 1/16W J	L404	2007-000093	CHIP BEAD	500Ω
R615	2401-002594	C RESISTOR	100Ω 1/16W J	L405	2007-000093	CHIP BEAD	500Ω
R616	2401-002594	C RESISTOR	100Ω 1/16W J	L406	2007-000094	CHIP BEAD	500Ω
R617	2401-002594	C RESISTOR	100Ω 1/16W J	L408	2007-000094	CHIP BEAD	500Ω
R618	2401-002594	C RESISTOR	100Ω 1/16W J	L501	2007-000094	CHIP BEAD	500Ω
R619	T2203-FC100D	C RESISTOR	0Ω 1/16W J	L502	2007-000094	CHIP BEAD	500Ω
R620	T2203-FC100D	C RESISTOR	0Ω 1/16W J	L504	2007-000094	CHIP BEAD	500Ω
R621	T2203-FC220D	C RESISTOR	0Ω 1/16W J	L505	2007-000129	CHIP BEAD	500Ω
R622	T2203-FC220D	C RESISTOR	0Ω 1/16W J	L507	2007-000129	CHIP BEAD	500Ω
R623	T1001-00083A	C RESISTOR	10KΩ 1/16W J	L509	2007-000129	CHIP BEAD	500Ω
R624	T1001-00082A	C RESISTOR	20KΩ 1/16W J	L510	2007-000129	CHIP BEAD	500Ω
R625	T3711-00033	C RESISTOR	1KΩ 1/16W J	L511	2007-000129	CHIP BEAD	500Ω
R629	T2401-CT2210	C RESISTOR	100Ω 1/16W J	L512	2007-000096	CHIP BEAD	500Ω
R630	T1001-00082A	C RESISTOR	20KΩ 1/16W J	L513	2007-000096	CHIP BEAD	500Ω
R631	T1001-00083A	C RESISTOR	10KΩ 1/16W J	L514	2007-000096	CHIP BEAD	500Ω
R632	T2203-FC102D	C RESISTOR	10Ω 1/16W J	L515	2007-000096	CHIP BEAD	500Ω
R633	T3711-00037	C RESISTOR	4.7KΩ 1/16W J	L516	2007-000096	CHIP BEAD	500Ω
R701	T2401-CT2210	C RESISTOR	100Ω 1/16W J	L517	2007-000097	CHIP BEAD	500Ω
R702	T2401-CT2210	C RESISTOR	100Ω 1/16W J	L5VA	2007-000120	CHIP BEAD	80Ω
R703	T2401-CT2210	C RESISTOR	100Ω 1/16W J	L5VB	2007-000120	CHIP BEAD	80Ω
R704	T2801-00013A	C RESISTOR	560Ω 1/16W J	L5VC	2007-000121	CHIP BEAD	80Ω
R705	T2801-00012A	C RESISTOR	820Ω 1/16W J	L601	T2007-HC472J	CHIP COIL	10uH
R707	T2203-FC103D	C RESISTOR	10Ω 1/16W J	L602	T2007-HC472J	CHIP COIL	10uH
R708	T2401-CT2210	C RESISTOR	100Ω 1/16W J	L603	2007-000097	CHIP BEAD	500Ω
R709	T2203-FC103D	C RESISTOR	10Ω 1/16W J	L606	2007-000097	CHIP BEAD	500Ω
R710	T3711-00033	C RESISTOR	1KΩ 1/16W J	L608	2007-000097	CHIP BEAD	500Ω
R711	T2203-FC330D	C RESISTOR	0Ω 1/16W J	L610	2007-000121	CHIP BEAD	80Ω
				L701	2007-000109	CHIP COIL	10uH

△Ref No.	Part No.	Part Name	Description	Local	△Ref No.	Part No.	Part Name	Description	Local
L703	2007-000102	SMD COIL	680uH		CE626	T2203-FC100D	E CAPACITOR	1uF 50V M	
L705	2007-000100	SMD COIL	470uH		CE627	2007-000102	E CAPACITOR	47uF 16V M	
L801	2007-000118	CHIP BEAD	80Ω		CE630	T2007-HC472J	E CAPACITOR	22uF 16V M	
L802	2007-000118	CHIP BEAD	80Ω		CE701	2007-000100	E CAPACITOR	100uF 16V M	
L803	2007-000118	CHIP BEAD	80Ω		CE702	T2203-FC102D	E CAPACITOR	10uF 16V M	
L804	2007-000118	CHIP BEAD	80Ω		CE703	2007-000100	E CAPACITOR	100uF 16V M	
L805	2007-000118	CHIP BEAD	80Ω		CE704	2007-000100	E CAPACITOR	100uF 16V M	
L806	2007-000077	CHIP BEAD	80Ω		CE705	T2203-FC100D	E CAPACITOR	1uF 50V M	
L807	2007-000077	CHIP BEAD	80Ω		CE801	T2203-FC103D	E CAPACITOR	220uF 16V M	
L808	2007-000077	CHIP BEAD	80Ω		CE802	T2203-FC221E	E CAPACITOR	470uF 16V M	
L809	2007-000077	CHIP BEAD	80Ω		CE803	2007-000107	E CAPACITOR	47uF 16V M	
L810	2007-000077	CHIP BEAD	80Ω		CE804	2007-000100	E CAPACITOR	100uF 16V M	
L812	2007-000119	CHIP BEAD	80Ω		CE805	T2203-DC104E	E CAPACITOR	220uF 16V M	
L813	2007-000119	CHIP BEAD	80Ω		CE808	T2203-FC104D	E CAPACITOR	220uF 16V M	
L814	2007-000107	SMD COIL	100uH		CE809	T2203-FC224D	E CAPACITOR	1000uF 10V M	
L815	2007-000119	CHIP BEAD	80Ω		CE810	T2203-FC222D	E CAPACITOR	470uF 16V M	
L816	2007-000119	CHIP BEAD	80Ω		CE811	T2203-DC104E	E CAPACITOR	220uF 16V M	
L820	2007-000119	CHIP BEAD	80Ω		J101	2401-002594	CONNECTOR		
L821	2007-000120	CHIP BEAD	80Ω		J102	T2401-CT2210	CONNECTOR		
L822	2007-000120	CHIP BEAD	80Ω		J201	T2203-FC472D	JACK	PC IN	
L823	2007-000120	CHIP BEAD	80Ω		J202	T2203-FC473D	JACK	EXT2	
L830	T3711-00033	C RESISTOR	1KΩ 1/16W J		J203	T2203-FC682D	JACK	EXT-1	
LA01	2007-000121	CHIP BEAD	80Ω		J205	T2203-FC104E	JACK	EXT-3/EXT4	
LA02	2007-000121	CHIP BEAD	80Ω		J209	T2401-FT0R1A	CONNECTOR		
CE101	2007-000097	E CAPACITOR	100uF 16V M		J210	2401-000269	CONNECTOR		
CE102	2007-000107	E CAPACITOR	47uF 16V M		J303	T2203-BC106E	CONNECTOR		
CE103	2007-000109	E CAPACITOR	22uF 16V M		J304	2401-001495	CONNECTOR		
CE105	T2203-FC220D	E CAPACITOR	10uF 16V M		J501	2401-000603	CONNECTOR		
CE107	T2203-FC060D	E CAPACITOR	1uF 50V M		J601	T2401-CT4700	CONNECTOR		
CE108	2007-000096	E CAPACITOR	0.1uF 50V M		J602	2401-000914	CONNECTOR		
CE202	T2203-FC220D	E CAPACITOR	10uF 16V M		J801	2401-002235	CONNECTOR		
CE203	T2203-FC220D	E CAPACITOR	10uF 16V M		RN301	2007-000084	BEAD ARRAY	120Ω	
CE204	T2203-FC220D	E CAPACITOR	10uF 16V M		RN302	2007-000084	BEAD ARRAY	120Ω	
CE205	T2203-FC220D	E CAPACITOR	10uF 16V M		RN303	2007-000084	BEAD ARRAY	120Ω	
CE206	T2203-FC103D	E CAPACITOR	220uF 16V M		RN304	2007-000084	BEAD ARRAY	120Ω	
CE207	T2203-FC103D	E CAPACITOR	220uF 16V M		RN305	2007-000084	BEAD ARRAY	120Ω	
CE220	2007-000097	E CAPACITOR	100uF 16V M		RN306	2007-000090	BEAD ARRAY	120Ω	
CE221	2007-000097	E CAPACITOR	100uF 16V M		RN307	2007-000090	BEAD ARRAY	120Ω	
CE301	T2203-FC150D	E CAPACITOR	100uF 10V M		RN308	T1001-00079A	CHIP ARRAY	4.7KΩ 1/16W J	
CE302	T2203-CC105D	E CAPACITOR	100uF 10V M		RN309	2007-000090	BEAD ARRAY	120Ω	
CE402	2007-000109	E CAPACITOR	22uF 16V M		RN310	T1001-00079A	CHIP ARRAY	4.7KΩ 1/16W J	
CE404	T2203-FC330D	E CAPACITOR	10uF 16V M		RN408	2007-000078	BEAD ARRAY	30Ω	
CE405	T2203-FC330D	E CAPACITOR	10uF 16V M		RN409	2007-000078	BEAD ARRAY	30Ω	
CE407	T2203-FC330D	E CAPACITOR	10uF 16V M		RN410	2007-000078	BEAD ARRAY	30Ω	
CE408	T2203-FC330D	E CAPACITOR	10uF 16V M		RN411	2007-000078	BEAD ARRAY	30Ω	
CE410	T2203-FC221E	E CAPACITOR	470uF 16V M		RN412	T1001-00049A	CHIP ARRAY	33Ω 1/16W J	
CE411	T2203-FC152D	E CAPACITOR	4.7uF 50V M		RN413	T1001-00049A	CHIP ARRAY	33Ω 1/16W J	
CE412	T2203-FC330D	E CAPACITOR	10uF 16V M		RN414	T1001-00049A	CHIP ARRAY	33Ω 1/16W J	
CE413	T2203-FC470D	E CAPACITOR	10uF 16V M		RN415	T1001-00049A	CHIP ARRAY	33Ω 1/16W J	
CE414	T2203-FC152D	E CAPACITOR	4.7uF 50V M		RN416	T1001-00049A	CHIP ARRAY	33Ω 1/16W J	
CE415	T2203-FC470D	E CAPACITOR	10uF 16V M		RN417	T1001-00078A	CHIP ARRAY	33Ω 1/16W J	
CE416	T2203-FC152D	E CAPACITOR	4.7uF 50V M		RN418	T1001-00078A	CHIP ARRAY	33Ω 1/16W J	
CE502	T2203-FC104D	E CAPACITOR	220uF 16V M		RN503	2007-000081	BEAD ARRAY	30Ω	
CE503	2007-000097	E CAPACITOR	100uF 16V M		RN505	2007-000081	BEAD ARRAY	30Ω	
CE504	2007-000107	E CAPACITOR	47uF 16V M		RN508	2007-000081	BEAD ARRAY	30Ω	
CE506	2007-000109	E CAPACITOR	22uF 16V M		RN509	2007-000081	BEAD ARRAY	30Ω	
CE507	2007-000109	E CAPACITOR	22uF 16V M		RN510	2007-000082	BEAD ARRAY	30Ω	
CE508	2007-000102	E CAPACITOR	47uF 16V M		RN511	2007-000082	BEAD ARRAY	30Ω	
CE509	2007-000109	E CAPACITOR	22uF 16V M		RN512	2007-000082	BEAD ARRAY	30Ω	
CE510	T2007-HC330J	E CAPACITOR	22uF 16V M		RN513	2007-000078	BEAD ARRAY	30Ω	
CE511	T2007-HC330J	E CAPACITOR	22uF 16V M		RN514	2007-000082	BEAD ARRAY	30Ω	
CE512	T2007-HC330J	E CAPACITOR	22uF 16V M		RN515	2007-000123	BEAD ARRAY	30Ω	
CE513	T2007-HC330J	E CAPACITOR	22uF 16V M		RN516	2007-000123	BEAD ARRAY	30Ω	
CE514	T2007-HC330J	E CAPACITOR	22uF 16V M		RN517	2007-000123	BEAD ARRAY	30Ω	
CE515	T2007-HC472J	E CAPACITOR	22uF 16V M		RN518	2007-000123	BEAD ARRAY	30Ω	
CE516	T2007-HC472J	E CAPACITOR	22uF 16V M		RN519	2007-000123	BEAD ARRAY	30Ω	
CE517	T2203-FC470D	E CAPACITOR	10uF 16V M		RN520	2007-000081	BEAD ARRAY	30Ω	
CE518	2007-000097	E CAPACITOR	100uF 16V M		X301	T2203-FC331D	CRYSTAL	6MHz	
CE601	T2203-FC103D	E CAPACITOR	220uF 16V M		X401	T2203-FC392D	CRYSTAL	27MHz	
CE602	T2203-FC103D	E CAPACITOR	220uF 16V M		X501	T2203-FC332D	CRYSTAL	14.318MHz	
CE603	2007-000102	E CAPACITOR	47uF 16V M		X601	T2203-FC334D	CRYSTAL	18.432MHz	
CE604	2007-000102	E CAPACITOR	47uF 16V M						
CE605	T2203-FC060D	E CAPACITOR	1uF 50V M						
CE606	T2203-CC105D	E CAPACITOR	100uF 10V M						
CE607	T2203-FC470D	E CAPACITOR	10uF 16V M						
CE608	T2203-FC470D	E CAPACITOR	10uF 16V M						
CE609	T2203-FC101D	E CAPACITOR	10uF 16V M						
CE610	T2203-FC101D	E CAPACITOR	10uF 16V M						
CE611	T2203-FC101D	E CAPACITOR	10uF 16V M						
CE612	2007-000102	E CAPACITOR	47uF 16V M						
CE613	T2203-FC101D	E CAPACITOR	10uF 16V M						
CE614	T2203-FC101D	E CAPACITOR	10uF 16V M						
CE617	T2203-FC102D	E CAPACITOR	10uF 16V M						
CE620	T2203-FC102D	E CAPACITOR	10uF 16V M						
CE621	T2203-FC102D	E CAPACITOR	10uF 16V M						
CE622	T2203-FC060D	E CAPACITOR	1uF 50V M						
CE623	T2203-FC060D	E CAPACITOR	1uF 50V M						
CE624	T2203-FC102D	E CAPACITOR	10uF 16V M						
CE625	T2203-FC060D	E CAPACITOR	1uF 50V M						

POWER P.W. BOARD ASS'Y (QAL0826-001)

REFER TO PARTS LIST IN PAGE 3-10 FOR THIS P.W. BOARD.

LED P.W. BOARD ASS'Y (QAL0827-001)

REFER TO PARTS LIST IN PAGE 3-12 FOR THIS P.W. BOARD.

KEY P.W. BOARD ASS'Y (QAL0828-001)

REFER TO PARTS LIST IN PAGE 3-12 FOR THIS P.W. BOARD.

PRINTED WIRING BOARD PARTS LIST [LT-32A61BU/c, LT-32A61SJ, LT-32A61SU]

MAIN P.W. BOARD ASS'Y (QAL0824-001)

△Ref No.	Part No.	Part Name	Description Local	△Ref No.	Part No.	Part Name	Description Local
U101	T1001-00081A	IC		ZD213	T2901-HC002A	Z DIODE	
U202	ATF02-32A61SJ	IC	(SERVICE)	ZD214	T2901-HC011A	Z DIODE	
U301	T1001-00073A-61	IC		ZD215	T2901-HC011A	Z DIODE	
U302	T1001-00064A	IC		ZD216	T2901-HC011A	Z DIODE	
U303	ATF32-32A61SJ	IC	(SERVICE)	ZD217	T2901-HC011A	Z DIODE	
U401	T1001-00084A	IC		ZD218	T2901-HC011A	Z DIODE	
U402	T1001-00085A	IC		ZD219	T2901-JC005A	Z DIODE	
U405	T1001-00075A	IC		ZD221	T2901-JC005A	Z DIODE	
U501	T1001-00086A	IC		ZD222	T2901-JC005A	Z DIODE	
U502	T1001-00063A	IC		ZD227	T2901-JC005A	Z DIODE	
U601	T1001-00087A	IC		ZD230	T2901-JC005A	Z DIODE	
U602	T1001-00088A	IC		ZD231	T2901-JC012B	Z DIODE	
U603	T1001-00070A	IC		ZD232	T2901-JC012B	Z DIODE	
U801	T0407-00004A	TRANSISTOR		ZD250	T2901-JC012B	Z DIODE	
U802	T0407-00004A	TRANSISTOR		ZD251	T2901-JC012B	Z DIODE	
Q101	T1001-00052A	IC		ZD252	T2901-JC012B	Z DIODE	
Q102	T0507-00001A	TRANSISTOR		ZD253	T2901-JC010B	Z DIODE	
Q103	T0507-00001A	TRANSISTOR		ZD254	T2901-JC010B	Z DIODE	
Q104	T0507-00001A	TRANSISTOR		ZD255	T2901-JC010B	Z DIODE	
Q105	T0507-00006A	TRANSISTOR		ZD256	T2901-JC010B	Z DIODE	
Q106	T0507-00001A	TRANSISTOR		ZD257	T2901-JC010B	Z DIODE	
Q202	T0507-00001A	TRANSISTOR		ZD258	T2901-JC004A	Z DIODE	
Q203	T0507-00005A	TRANSISTOR		ZD259	T2901-JC004A	Z DIODE	
Q301	T1001-00049A	IC		ZD260	T2901-JC004A	Z DIODE	
Q303	T1001-00078A	IC		ZD261	T2901-JC004A	Z DIODE	
Q304	T0507-00003A	TRANSISTOR		ZD262	T2901-JC004A	Z DIODE	
Q305	T0507-00003A	TRANSISTOR		ZD263	T2703-KC007A	Z DIODE	
Q306	T0507-00007A	TRANSISTOR		ZD264	T2703-KC007A	Z DIODE	
Q307	T0407-00003A	TRANSISTOR		ZD267	T2703-KC007A	Z DIODE	
Q308	T0507-00005A	TRANSISTOR		ZD270	T2703-KC007A	Z DIODE	
Q309	T0507-00005A	TRANSISTOR		ZD271	T2703-KC007A	Z DIODE	
Q311	T0507-00005A	TRANSISTOR		ZD280	T2703-KC014A	Z DIODE	
Q312	T0507-00006A	TRANSISTOR		ZD281	T2703-KC014A	Z DIODE	
Q315	T0507-00006A	TRANSISTOR		ZD702	T2703-JC011A	DIODE	
Q316	T0507-00005A	TRANSISTOR		ZD2213	T2703-KC014A	Z DIODE	
Q317	T0407-00003A	TRANSISTOR		ZD2214	T2703-KC014A	Z DIODE	
Q403	T0507-00006A	TRANSISTOR		ZD2215	T2703-KC014A	Z DIODE	
Q501	T1001-00079A	IC		ZD2216	T2703-LC010A	Z DIODE	
Q502	T1001-00048A	IC		ZD2274	T2703-LC010A	Z DIODE	
Q503	T0507-00007A	TRANSISTOR		C101	T0407-00002A	C CAPACITOR	100nF 25V K
Q601	T0507-00006A	TRANSISTOR		C103	2007-000094	C CAPACITOR	10uF 10V Z
Q602	T0507-00002A	TRANSISTOR		C105	2007-000093	C CAPACITOR	100nF 50V Z
Q603	T0507-00002A	TRANSISTOR		C106	2007-000094	C CAPACITOR	10uF 10V Z
Q604	T0407-00002A	TRANSISTOR		C107	2007-000094	C CAPACITOR	10uF 10V Z
Q701	T0507-00002A	TRANSISTOR		C109	2007-000094	C CAPACITOR	10uF 10V Z
Q702	T0507-00002A	TRANSISTOR		C110	2007-000094	C CAPACITOR	10uF 10V Z
Q703	T0507-00002A	TRANSISTOR		C113	2007-000129	C CAPACITOR	10uF 10V Z
Q801	T1001-00089A	IC		C201	T0507-00005A	C CAPACITOR	1nF 50V K
Q802	T0507-00008A	TRANSISTOR		C202	2007-000081	C CAPACITOR	47nF 50V K
Q804	T1001-00051A	IC		C203	2007-000081	C CAPACITOR	47nF 50V K
Q805	T0507-00008A	TRANSISTOR		C204	2007-000081	C CAPACITOR	47nF 50V K
Q806	T0507-00008A	TRANSISTOR		C205	2007-000081	C CAPACITOR	47nF 50V K
Q2203	T0407-00002A	TRANSISTOR		C206	2007-000081	C CAPACITOR	47nF 50V K
D101	T0408-00002A	DIODE		C207	2007-000082	C CAPACITOR	47nF 50V K
D205	T2703-IC002A	Z DIODE		C208	2007-000082	C CAPACITOR	47nF 50V K
D206	T2703-IC002A	Z DIODE		C209	2007-000082	C CAPACITOR	47nF 50V K
D207	T2703-IC002A	Z DIODE		C210	T0507-00005A	C CAPACITOR	1nF 50V K
D208	T2703-IC002A	Z DIODE		C211	2007-000082	C CAPACITOR	47nF 50V K
D209	T2703-IC002A	Z DIODE		C213	T1001-00089A	C CAPACITOR	10pF 50V K
D210	T2703-IC002A	Z DIODE		C214	T1001-00089A	C CAPACITOR	10pF 50V K
D222	2007-000070	DIODE		C215	T1001-00089A	C CAPACITOR	10pF 50V K
D223	2007-000070	DIODE		C216	2007-000120	C CAPACITOR	0.47nF 50V K
D224	2007-000070	DIODE		C218	2007-000120	C CAPACITOR	0.47nF 50V K
D225	2007-000070	DIODE		C219	2007-000120	C CAPACITOR	0.47nF 50V K
D226	2007-000070	DIODE		C220	2007-000120	C CAPACITOR	0.47nF 50V K
D227	2007-000882	DIODE		C221	2007-000120	C CAPACITOR	0.47nF 50V K
D228	2007-000882	DIODE		C222	2007-000121	C CAPACITOR	0.47nF 50V K
D229	2007-000882	DIODE		C223	2007-000121	C CAPACITOR	0.47nF 50V K
D301	T0408-00002A	DIODE		C226	2007-000121	C CAPACITOR	0.47nF 50V K
D601	T0408-00002A	DIODE		C227	2007-000082	C CAPACITOR	47nF 50V K
D602	T0408-00002A	DIODE		C228	2007-000084	C CAPACITOR	47nF 50V K
D702	T0408-00002A	DIODE		C229	2007-000084	C CAPACITOR	47nF 50V K
D704	T0408-00002A	DIODE		C230	2007-000121	C CAPACITOR	0.47nF 50V K
D801	T0407-00005A	DIODE		C233	2007-000121	C CAPACITOR	0.47nF 50V K
ZD101	T0408-00009A	Z DIODE		C234	2007-000078	C CAPACITOR	0.47nF 50V K
ZD202	T0408-00009A	Z DIODE		C235	2007-000078	C CAPACITOR	0.47nF 50V K
ZD203	T0408-00009A	Z DIODE		C236	T1001-00089A	C CAPACITOR	10pF 50V K
ZD204	T0408-00009A	Z DIODE		C238	T1001-00089A	C CAPACITOR	10pF 50V K
ZD206	T0408-00009A	Z DIODE		C242	2007-000643	C CAPACITOR	0.33nF 50V K
ZD209	T2901-HC002A	Z DIODE		C243	2007-000643	C CAPACITOR	0.33nF 50V K
ZD210	T2901-HC002A	Z DIODE		C244	2007-000643	C CAPACITOR	0.33nF 50V K
ZD211	T2901-HC002A	Z DIODE		C248	2007-000077	C CAPACITOR	330nF 16V Z
ZD212	T2901-HC002A	Z DIODE		C249	2007-000077	C CAPACITOR	330nF 16V Z
				C252	T0407-00002A	C CAPACITOR	100nF 25V K
				C253	T0407-00002A	C CAPACITOR	100nF 25V K
				C254	T0407-00002A	C CAPACITOR	100nF 25V K

△Ref No.	Part No.	Part Name	Description Local	△Ref No.	Part No.	Part Name	Description Local
C255	T0407-00002A	C CAPACITOR	100nF 25V K	C516	T2703-KC014A	C CAPACITOR	100nF 25V K
C256	T0407-00004A	C CAPACITOR	100nF 25V K	C517	T2703-LC010A	C CAPACITOR	100nF 25V K
C257	T0407-00004A	C CAPACITOR	100nF 25V K	C518	T2703-LC010A	C CAPACITOR	100nF 25V K
C258	T0407-00004A	C CAPACITOR	100nF 25V K	C519	T2703-LC010A	C CAPACITOR	100nF 25V K
C259	T0407-00004A	C CAPACITOR	100nF 25V K	C520	T2703-LC010A	C CAPACITOR	100nF 25V K
C301	T0407-00004A	C CAPACITOR	100nF 25V K	C524	T2703-LC010A	C CAPACITOR	100nF 25V K
C302	T0407-00003A	C CAPACITOR	100nF 25V K	C525	T2703-IC002A	C CAPACITOR	100nF 25V K
C303	T0407-00003A	C CAPACITOR	100nF 25V K	C526	T2703-IC002A	C CAPACITOR	100nF 25V K
C304	T0407-00003A	C CAPACITOR	100nF 25V K	C527	T2703-IC002A	C CAPACITOR	100nF 25V K
C305	T0407-00003A	C CAPACITOR	100nF 25V K	C528	T2703-IC002A	C CAPACITOR	100nF 25V K
C306	2007-000074	C CAPACITOR	0.22nF 50V K	C529	T2703-IC002A	C CAPACITOR	100nF 25V K
C307	T0507-00002A	C CAPACITOR	10nF 50V K	C530	T2703-IC002A	C CAPACITOR	100nF 25V K
C308	2007-000075	C CAPACITOR	220nF 50V K	C531	T2703-IC002A	C CAPACITOR	100nF 25V K
C309	T0407-00003A	C CAPACITOR	100nF 25V K	C532	T2703-IC002A	C CAPACITOR	100nF 25V K
C310	T0408-00002A	C CAPACITOR	100nF 25V K	C533	T2703-IC002A	C CAPACITOR	100nF 25V K
C311	T0507-00007A	C CAPACITOR	33pF 50V K	C534	T2703-IC002A	C CAPACITOR	100nF 25V K
C312	T0507-00001A	C CAPACITOR	0.1nF 50V K	C535	T2703-JC011A	C CAPACITOR	100nF 25V K
C313	T0507-00001A	C CAPACITOR	0.1nF 50V K	C536	T2703-JC011A	C CAPACITOR	100nF 25V K
C314	T0507-00001A	C CAPACITOR	0.1nF 50V K	C537	T2703-JC011A	C CAPACITOR	100nF 25V K
C316	T0507-00007A	C CAPACITOR	33pF 50V K	C538	T2703-JC011A	C CAPACITOR	100nF 25V K
C317	T0408-00002A	C CAPACITOR	100nF 25V K	C539	T2703-JC011A	C CAPACITOR	100nF 25V K
C318	T0408-00002A	C CAPACITOR	100nF 25V K	C540	2007-000070	C CAPACITOR	100nF 25V K
C319	T0408-00002A	C CAPACITOR	100nF 25V K	C541	2007-000070	C CAPACITOR	100nF 25V K
C402	T0408-00002A	C CAPACITOR	100nF 25V K	C543	2007-000070	C CAPACITOR	100nF 25V K
C403	T0408-00002A	C CAPACITOR	100nF 25V K	C544	2007-000070	C CAPACITOR	100nF 25V K
C404	T0408-00002A	C CAPACITOR	100nF 25V K	C545	2007-000070	C CAPACITOR	100nF 25V K
C405	T0408-00002A	C CAPACITOR	100nF 25V K	C546	2007-000882	C CAPACITOR	100nF 25V K
C406	T0408-00002A	C CAPACITOR	100nF 25V K	C548	2007-000882	C CAPACITOR	100nF 25V K
C407	T0408-00002A	C CAPACITOR	100nF 25V K	C549	2007-000882	C CAPACITOR	100nF 25V K
C409	T0407-00005A	C CAPACITOR	100nF 25V K	C550	T1001-00051A	C CAPACITOR	10pF 50V K
C411	T0407-00005A	C CAPACITOR	100nF 25V K	C552	2007-000882	C CAPACITOR	100nF 25V K
C412	T0407-00005A	C CAPACITOR	100nF 25V K	C553	T0507-00007A	C CAPACITOR	33pF 50V K
C413	T0407-00005A	C CAPACITOR	100nF 25V K	C554	T0507-00007A	C CAPACITOR	33pF 50V K
C414	T0407-00005A	C CAPACITOR	100nF 25V K	C555	2007-000882	C CAPACITOR	100nF 25V K
C415	T0408-000009A	C CAPACITOR	100nF 25V K	C556	T0507-00005A	C CAPACITOR	1nF 50V K
C416	T0408-000009A	C CAPACITOR	100nF 25V K	C557	T1001-00051A	C CAPACITOR	10pF 50V K
C417	T0408-000009A	C CAPACITOR	100nF 25V K	C559	2007-001134	C CAPACITOR	1uF 16V Z
C419	T0408-000009A	C CAPACITOR	100nF 25V K	C601	2007-000309	C CAPACITOR	100nF 25V K
C420	T0408-000009A	C CAPACITOR	100nF 25V K	C604	2007-000118	C CAPACITOR	3.3nF 50V K
C421	2007-000115	C CAPACITOR	1.5nF 50V K	C605	2007-000118	C CAPACITOR	3.3nF 50V K
C422	2007-000115	C CAPACITOR	1.5nF 50V K	C606	T1001-00048A	C CAPACITOR	6pF 50V K
C423	2007-000115	C CAPACITOR	1.5nF 50V K	C607	T1001-00048A	C CAPACITOR	6pF 50V K
C424	T0507-00001A	C CAPACITOR	0.1nF 50V K	C608	T0507-00006A	C CAPACITOR	47pF 50V K
C425	T0507-00003A	C CAPACITOR	22pF 50V K	C610	2007-000309	C CAPACITOR	100nF 25V K
C426	T0507-00003A	C CAPACITOR	22pF 50V K	C611	T0507-00006A	C CAPACITOR	47pF 50V K
C427	T2901-HC002A	C CAPACITOR	100nF 25V K	C612	T2203-FC100D	C RESISTOR	0Ω 1/16W J
C428	T2901-HC002A	C CAPACITOR	100nF 25V K	C614	2007-000123	C CAPACITOR	4.7nF 50V K
C429	T2901-HC002A	C CAPACITOR	100nF 25V K	C615	2007-000643	C CAPACITOR	0.33nF 50V K
C430	T2901-HC002A	C CAPACITOR	100nF 25V K	C616	2007-000643	C CAPACITOR	0.33nF 50V K
C431	T2901-HC002A	C CAPACITOR	100nF 25V K	C617	2007-000309	C CAPACITOR	100nF 25V K
C432	T2901-HC011A	C CAPACITOR	100nF 25V K	C618	T0507-00002A	C CAPACITOR	10nF 50V K
C433	T2901-HC011A	C CAPACITOR	100nF 25V K	C619	T0507-00002A	C CAPACITOR	10nF 50V K
C434	T2901-HC011A	C CAPACITOR	100nF 25V K	C620	T0507-00002A	C CAPACITOR	10nF 50V K
C435	T2901-HC011A	C CAPACITOR	100nF 25V K	C621	2007-000309	C CAPACITOR	100nF 25V K
C436	T1001-00051A	C CAPACITOR	10pF 50V K	C623	2007-000119	C CAPACITOR	3.9nF 50V K
C438	T2901-HC011A	C CAPACITOR	100nF 25V K	C624	2007-000119	C CAPACITOR	3.9nF 50V K
C439	T2901-JC005A	C CAPACITOR	100nF 25V K	C625	T0507-00005A	C CAPACITOR	1nF 50V K
C440	T2901-JC005A	C CAPACITOR	100nF 25V K	C626	2007-000076	C CAPACITOR	0.33nF 50V K
C441	T2901-JC005A	C CAPACITOR	100nF 25V K	C627	2007-000076	C CAPACITOR	0.33nF 50V K
C442	T2901-JC005A	C CAPACITOR	100nF 25V K	C632	2007-000076	C CAPACITOR	0.33nF 50V K
C443	T2901-JC005A	C CAPACITOR	100nF 25V K	C633	2007-000076	C CAPACITOR	0.33nF 50V K
C444	T2901-JC012B	C CAPACITOR	100nF 25V K	C634	2007-001134	C CAPACITOR	1uF 16V Z
C445	T2901-JC012B	C CAPACITOR	100nF 25V K	C635	2007-001134	C CAPACITOR	1uF 16V Z
C446	T2901-JC012B	C CAPACITOR	100nF 25V K	C636	T0507-00006A	C CAPACITOR	47pF 50V K
C447	T2901-JC012B	C CAPACITOR	100nF 25V K	C638	2007-000309	C CAPACITOR	100nF 25V K
C451	T0507-00002A	C CAPACITOR	10nF 50V K	C639	2007-000090	C CAPACITOR	6.8nF 50V K
C452	T2901-JC012B	C CAPACITOR	100nF 25V K	C640	2007-000090	C CAPACITOR	6.8nF 50V K
C453	T2901-JC010B	C CAPACITOR	100nF 25V K	C701	2007-000071	C CAPACITOR	100nF 25V K
C454	T2901-JC010B	C CAPACITOR	100nF 25V K	C702	2007-000071	C CAPACITOR	100nF 25V K
C455	2007-000078	C CAPACITOR	0.47nF 50V K	C703	T0507-00008A	C CAPACITOR	10nF 50V K
C456	T2901-JC010B	C CAPACITOR	100nF 25V K	C707	2007-000072	C CAPACITOR	100nF 50V K
C457	T2901-JC010B	C CAPACITOR	100nF 25V K	C710	2007-000084	C CAPACITOR	47nF 50V K
C458	T2901-JC010B	C CAPACITOR	100nF 25V K	C712	2007-001167	C CAPACITOR	0.15nF 50V K
C459	2007-001167	C CAPACITOR	0.15nF 50V K	C714	2007-000402	C CAPACITOR	2.2nF 50V K
C460	2007-001167	C CAPACITOR	0.15nF 50V K	C715	T0507-00005A	C CAPACITOR	1nF 50V K
C461	2007-000115	C CAPACITOR	1.5nF 50V K	C801	2007-000071	C CAPACITOR	100nF 25V K
C501	T2901-JC004A	C CAPACITOR	100nF 25V K	C802	2007-000071	C CAPACITOR	100nF 25V K
C502	T2901-JC004A	C CAPACITOR	100nF 25V K	C805	2007-000071	C CAPACITOR	100nF 25V K
C503	T2901-JC004A	C CAPACITOR	100nF 25V K	C806	2007-000113	C CAPACITOR	100nF 25V K
C504	T2901-JC004A	C CAPACITOR	100nF 25V K	C807	2007-000113	C CAPACITOR	100nF 25V K
C506	T2901-JC004A	C CAPACITOR	100nF 25V K	C820	2007-000113	C CAPACITOR	100nF 25V K
C507	T2703-KC007A	C CAPACITOR	100nF 25V K	C821	2007-000113	C CAPACITOR	100nF 25V K
C508	T2703-KC007A	C CAPACITOR	100nF 25V K	C2251	2007-000113	C CAPACITOR	100nF 25V K
C509	T2703-KC007A	C CAPACITOR	100nF 25V K	CA02	T0507-00006A	C CAPACITOR	47pF 50V K
C510	T2703-KC007A	C CAPACITOR	100nF 25V K	CA03	T0507-00006A	C CAPACITOR	47pF 50V K
C511	T2703-KC007A	C CAPACITOR	100nF 25V K				
C512	T2703-KC014A	C CAPACITOR	100nF 25V K	L301	T3711-00037	C RESISTOR	4.7KΩ 1/16W J
C513	T2703-KC014A	C CAPACITOR	100nF 25V K	R101	2401-001363	C RESISTOR	330Ω 1/16W J
C514	T2703-KC014A	C CAPACITOR	100nF 25V K	R102	2401-001363	C RESISTOR	330Ω 1/16W J
C515	T2703-KC014A	C CAPACITOR	100nF 25V K	R104	2401-001363	C RESISTOR	330Ω 1/16W J

△Ref No.	Part No.	Part Name	Description Local	△Ref No.	Part No.	Part Name	Description Local
R107	T2401-BT1010	C RESISTOR	220Ω 1/16W J	R310	T1001-00064A	C RESISTOR	10KΩ 1/16W J
R108	T2203-FC060D	C RESISTOR	0Ω 1/16W J	R313	2401-001495	C RESISTOR	100Ω 1/16W J
R109	T1001-00087A	C RESISTOR	100KΩ 1/16W J	R314	T3711-00037	C RESISTOR	4.7KΩ 1/16W J
R110	T1001-00087A	C RESISTOR	100KΩ 1/16W J	R315	T2203-FC101D	C RESISTOR	10Ω 1/16W J
R114	T1001-00087A	C RESISTOR	100KΩ 1/16W J	R316	T2203-FC101D	C RESISTOR	10Ω 1/16W J
R115	2401-001363	C RESISTOR	330Ω 1/16W J	R317	T2203-FC101D	C RESISTOR	10Ω 1/16W J
R119	2401-001363	C RESISTOR	330Ω 1/16W J	R318	T3711-00035	C RESISTOR	2.7KΩ 1/16W J
R121	T1001-00087A	C RESISTOR	100KΩ 1/16W J	R319	T2203-FC101D	C RESISTOR	10Ω 1/16W J
R123	T2401-CT4710	C RESISTOR	330Ω 1/16W J	R320	2401-001495	C RESISTOR	100Ω 1/16W J
R124	T2401-BT1010	C RESISTOR	220Ω 1/16W J	R321	T3711-00035	C RESISTOR	2.7KΩ 1/16W J
R126	TA40-00016A	C RESISTOR	1KΩ 1/16W J	R322	2401-001495	C RESISTOR	100Ω 1/16W J
R127	T1001-00073A	C RESISTOR	10KΩ 1/16W J	R327	2401-001495	C RESISTOR	100Ω 1/16W J
R128	T1001-00073A	C RESISTOR	10KΩ 1/16W J	R328	T2401-CT4700	C RESISTOR	100Ω 1/16W J
R129	T1001-00073A	C RESISTOR	10KΩ 1/16W J	R329	T2203-FC473D	C RESISTOR	75Ω 1/16W J
R130	TA40-00016A	C RESISTOR	1KΩ 1/16W J	R330	T3711-00037	C RESISTOR	4.7KΩ 1/16W J
R131	T3711-00034	C RESISTOR	1.5KΩ 1/16W J	R331	T2401-CT4700	C RESISTOR	100Ω 1/16W J
R132	T1001-00086A	C RESISTOR	47KΩ 1/16W J	R332	T2203-DC104E	C RESISTOR	22Ω 1/16W J
R133	T2401-BT1010	C RESISTOR	220Ω 1/16W J	R333	T2203-DC104E	C RESISTOR	22Ω 1/16W J
R134	T1001-00073A	C RESISTOR	10KΩ 1/16W J	R335	T1001-00084A	C RESISTOR	22KΩ 1/16W J
R136	T1001-00085A	C RESISTOR	27KΩ 1/16W J	R336	T1001-00086A	C RESISTOR	47KΩ 1/16W J
R138	T1001-00073A	C RESISTOR	10KΩ 1/16W J	R337	T3711-00036	C RESISTOR	3.3KΩ 1/16W J
R210	2401-002075	C RESISTOR	270Ω 1/16W J	R338	T3711-00036	C RESISTOR	3.3KΩ 1/16W J
R211	T2401-FT0R1A	C RESISTOR	100Ω 1/16W J	R339	T3711-00036	C RESISTOR	3.3KΩ 1/16W J
R214	TA40-00016A	C RESISTOR	1KΩ 1/16W J	R340	T2203-DC104E	C RESISTOR	22Ω 1/16W J
R215	TA40-00016A	C RESISTOR	1KΩ 1/16W J	R341	T2401-CT4700	C RESISTOR	100Ω 1/16W J
R216	TA40-00016A	C RESISTOR	1KΩ 1/16W J	R342	T2203-FC101D	C RESISTOR	10Ω 1/16W J
R217	T3722-00054A	C RESISTOR	1KΩ 1/16W J	R343	T3722-00040A	C RESISTOR	1KΩ 1/16W J
R218	T3722-00054A	C RESISTOR	1KΩ 1/16W J	R344	T2401-CT4700	C RESISTOR	100Ω 1/16W J
R219	T3722-00054A	C RESISTOR	1KΩ 1/16W J	R345	T2401-CT4700	C RESISTOR	100Ω 1/16W J
R220	T3722-00054A	C RESISTOR	1KΩ 1/16W J	R346	2401-000914	C RESISTOR	100Ω 1/16W J
R223	T2801-00011A	C RESISTOR	470Ω 1/16W J	R347	2401-000914	C RESISTOR	100Ω 1/16W J
R224	T2203-FC152D	C RESISTOR	33Ω 1/16W J	R348	2401-000914	C RESISTOR	100Ω 1/16W J
R225	T2203-FC392D	C RESISTOR	75Ω 1/16W J	R349	T3711-00037	C RESISTOR	4.7KΩ 1/16W J
R226	T2203-FC152D	C RESISTOR	33Ω 1/16W J	R350	T3711-00037	C RESISTOR	4.7KΩ 1/16W J
R227	T2203-FC392D	C RESISTOR	75Ω 1/16W J	R351	T2203-FC221E	C RESISTOR	33Ω 1/16W J
R228	T2203-FC152D	C RESISTOR	33Ω 1/16W J	R352	T2203-FC221E	C RESISTOR	33Ω 1/16W J
R229	T2203-FC392D	C RESISTOR	75Ω 1/16W J	R353	T2203-FC221E	C RESISTOR	33Ω 1/16W J
R230	T2203-FC152D	C RESISTOR	33Ω 1/16W J	R354	T2203-FC222D	C RESISTOR	33Ω 1/16W J
R231	T2203-FC152D	C RESISTOR	33Ω 1/16W J	R355	2401-000914	C RESISTOR	100Ω 1/16W J
R232	T2801-00011A	C RESISTOR	470Ω 1/16W J	R356	2401-000914	C RESISTOR	100Ω 1/16W J
R233	T2203-FC221E	C RESISTOR	33Ω 1/16W J	R357	T3711-00036	C RESISTOR	3.3KΩ 1/16W J
R235	T2203-FC392D	C RESISTOR	75Ω 1/16W J	R358	2401-000603	C RESISTOR	100Ω 1/16W J
R236	T2203-FC392D	C RESISTOR	75Ω 1/16W J	R359	2401-000603	C RESISTOR	100Ω 1/16W J
R237	T2203-FC104E	C RESISTOR	82Ω 1/16W J	R360	T3711-00036	C RESISTOR	3.3KΩ 1/16W J
R238	T2203-FC104E	C RESISTOR	82Ω 1/16W J	R361	T3711-00019	C RESISTOR	4.7KΩ 1/16W J
R239	T2203-FC104E	C RESISTOR	82Ω 1/16W J	R363	T2801-00014A	C RESISTOR	680Ω 1/16W J
R242	T2203-FC471D	C RESISTOR	75Ω 1/16W J	R364	T2203-FC102D	C RESISTOR	10Ω 1/16W J
R243	T3722-00054A	C RESISTOR	1KΩ 1/16W J	R365	T3711-00019	C RESISTOR	4.7KΩ 1/16W J
R244	T3722-00040A	C RESISTOR	1KΩ 1/16W J	R367	2401-000603	C RESISTOR	100Ω 1/16W J
R245	T2203-FC471D	C RESISTOR	75Ω 1/16W J	R370	T1001-00064A	C RESISTOR	10KΩ 1/16W J
R246	T2203-FC471D	C RESISTOR	75Ω 1/16W J	R371	T2401-CT4710	C RESISTOR	330Ω 1/16W J
R247	T2203-FC471D	C RESISTOR	75Ω 1/16W J	R373	2401-000603	C RESISTOR	100Ω 1/16W J
R248	T1001-00064A	C RESISTOR	10KΩ 1/16W J	R375	T1001-00064A	C RESISTOR	10KΩ 1/16W J
R249	T1001-00064A	C RESISTOR	10KΩ 1/16W J	R376	2401-002075	C RESISTOR	270Ω 1/16W J
R255	T2401-FT0R1A	C RESISTOR	100Ω 1/16W J	R377	T2203-FC060D	C RESISTOR	0Ω 1/16W J
R256	T2203-FC471D	C RESISTOR	75Ω 1/16W J	R378	T3722-00040A	C RESISTOR	1KΩ 1/16W J
R260	T2203-FC472D	C RESISTOR	75Ω 1/16W J	R380	T1001-00083A	C RESISTOR	10KΩ 1/16W J
R261	T1001-00085A	C RESISTOR	27KΩ 1/16W J	R382	2401-000603	C RESISTOR	100Ω 1/16W J
R262	T2203-FC472D	C RESISTOR	75Ω 1/16W J	R383	T2801-00013A	C RESISTOR	560Ω 1/16W J
R263	T2203-FC472D	C RESISTOR	75Ω 1/16W J	R385	2401-002235	C RESISTOR	100Ω 1/16W J
R264	T2203-FC472D	C RESISTOR	75Ω 1/16W J	R390	T3711-00019	C RESISTOR	4.7KΩ 1/16W J
R267	T2203-FC472D	C RESISTOR	75Ω 1/16W J	R391	T2203-FC060D	C RESISTOR	0Ω 1/16W J
R271	T2401-FT0R1A	C RESISTOR	100Ω 1/16W J	R392	T3711-00019	C RESISTOR	4.7KΩ 1/16W J
R272	T2401-FT0R1A	C RESISTOR	100Ω 1/16W J	R393	2401-002235	C RESISTOR	100Ω 1/16W J
R273	2401-002075	C RESISTOR	270Ω 1/16W J	R394	T3722-00040A	C RESISTOR	1KΩ 1/16W J
R274	T2401-FT0R1A	C RESISTOR	100Ω 1/16W J	R395	T2203-FC330D	C RESISTOR	0Ω 1/16W J
R275	T2203-FC060D	C RESISTOR	0Ω 1/16W J	R396	T3711-00029	C RESISTOR	3.3KΩ 1/16W J
R277	T2203-FC060D	C RESISTOR	0Ω 1/16W J	R397	T3711-00029	C RESISTOR	3.3KΩ 1/16W J
R278	T3722-00040A	C RESISTOR	1KΩ 1/16W J	R411	T2801-00011A	C RESISTOR	470Ω 1/16W J
R279	T3722-00040A	C RESISTOR	1KΩ 1/16W J	R412	T2203-FC334D	C RESISTOR	68Ω 1/16W J
R280	T3722-00040A	C RESISTOR	1KΩ 1/16W J	R413	2401-002235	C RESISTOR	100Ω 1/16W J
R281	T2203-FC104E	C RESISTOR	82Ω 1/16W J	R414	T2203-FC222D	C RESISTOR	33Ω 1/16W J
R282	T2203-FC104E	C RESISTOR	82Ω 1/16W J	R415	T2801-00014A	C RESISTOR	680Ω 1/16W J
R283	T2203-BC106E	C RESISTOR	82Ω 1/16W J	R416	T2203-DC104E	C RESISTOR	22Ω 1/16W J
R285	T2203-FC473D	C RESISTOR	75Ω 1/16W J	R417	T2203-DC104E	C RESISTOR	22Ω 1/16W J
R286	T1001-00085A	C RESISTOR	27KΩ 1/16W J	R418	T3711-00019	C RESISTOR	4.7KΩ 1/16W J
R287	T2203-FC470D	C RESISTOR	4.7Ω 1/16W J	R419	T2203-FC100D	C RESISTOR	0Ω 1/16W J
R288	T2203-FC473D	C RESISTOR	75Ω 1/16W J	R427	T1001-00052A	C RESISTOR	1MΩ 1/16W J
R289	T2203-FC473D	C RESISTOR	75Ω 1/16W J	R429	T2203-FC222D	C RESISTOR	33Ω 1/16W J
R290	2401-000269	C RESISTOR	100Ω 1/16W J	R432	T2203-FC222D	C RESISTOR	33Ω 1/16W J
R291	2401-000269	C RESISTOR	100Ω 1/16W J	R434	T2203-FC222D	C RESISTOR	33Ω 1/16W J
R292	T3722-00040A	C RESISTOR	1KΩ 1/16W J	R436	T2203-FC224D	C RESISTOR	33Ω 1/16W J
R294	T2203-FC470D	C RESISTOR	4.7Ω 1/16W J	R442	T2203-FC331D	C RESISTOR	33Ω 1/16W J
R295	T2203-FC473D	C RESISTOR	75Ω 1/16W J	R456	T3711-00038	C RESISTOR	4.7KΩ 1/16W J
R296	T3722-00040A	C RESISTOR	1KΩ 1/16W J	R457	T2203-FC682D	C RESISTOR	75Ω 1/16W J
R299	T2203-FC221E	C RESISTOR	33Ω 1/16W J	R458	T2203-FC682D	C RESISTOR	75Ω 1/16W J
R304	2401-000269	C RESISTOR	100Ω 1/16W J	R459	T2203-FC682D	C RESISTOR	75Ω 1/16W J
R305	2401-000269	C RESISTOR	100Ω 1/16W J	R460	T3711-00038	C RESISTOR	4.7KΩ 1/16W J
R307	2401-000269	C RESISTOR	100Ω 1/16W J	R461	T1001-00070A	C RESISTOR	470KΩ 1/16W J
R308	2401-001495	C RESISTOR	100Ω 1/16W J	R462	T3711-00038	C RESISTOR	4.7KΩ 1/16W J

△Ref No.	Part No.	Part Name	Description Local	△Ref No.	Part No.	Part Name	Description Local
R501	T1001-00083A	C RESISTOR	10KΩ 1/16W J	R712	T1001-00088A	C RESISTOR	100KΩ 1/16W J
R504	T3711-00038	C RESISTOR	4.7KΩ 1/16W J	R713	T1001-00084A	C RESISTOR	22KΩ 1/16W J
R505	T1001-00087A	C RESISTOR	100KΩ 1/16W J	R801	T1001-00083A	C RESISTOR	10KΩ 1/16W J
R509	2007-001167	CHIP BEAD	30Ω	R802	T3711-00037	C RESISTOR	4.7KΩ 1/16W J
R510	2007-001167	CHIP BEAD	30Ω	R803	2401-002075	C RESISTOR	270Ω 1/16W J
R511	2007-001167	CHIP BEAD	30Ω	R804	AA60-40014A	C RESISTOR	4.7KΩ 1/16W J
R515	2007-001167	CHIP BEAD	30Ω	R805	AA60-40014A	C RESISTOR	4.7KΩ 1/16W J
R516	2007-001167	CHIP BEAD	30Ω	R806	AA60-40014A	C RESISTOR	4.7KΩ 1/16W J
R517	2007-000115	CHIP BEAD	30Ω	R810	T2203-FC220D	C RESISTOR	0Ω 1/16W J
R518	2007-000115	CHIP BEAD	30Ω	R2215	T2203-FC332D	C RESISTOR	47Ω 1/16W J
R519	2007-000115	CHIP BEAD	30Ω	R2219	T2203-FC104D	C RESISTOR	22Ω 1/16W J
R529	T2203-FC100D	C RESISTOR	0Ω 1/16W J	R2220	T2203-FC104D	C RESISTOR	22Ω 1/16W J
R540	T2203-FC102D	C RESISTOR	10Ω 1/16W J	R2221	T2203-FC104D	C RESISTOR	22Ω 1/16W J
R541	2007-000115	CHIP BEAD	30Ω	R2222	T2203-FC104D	C RESISTOR	22Ω 1/16W J
R542	2007-000115	CHIP BEAD	30Ω	R2223	T2203-CC105D	C RESISTOR	22Ω 1/16W J
R543	2007-000074	CHIP BEAD	30Ω	R2224	T2203-CC105D	C RESISTOR	22Ω 1/16W J
R544	T2203-FC104D	C RESISTOR	22Ω 1/16W J	R2225	T2203-CC105D	C RESISTOR	22Ω 1/16W J
R546	2007-000074	CHIP BEAD	30Ω	R2226	T2203-CC105D	C RESISTOR	22Ω 1/16W J
R548	2007-000074	CHIP BEAD	30Ω	R2227	T2203-CC105D	C RESISTOR	22Ω 1/16W J
R550	2007-000074	CHIP BEAD	30Ω	R2228	T2203-FC150D	C RESISTOR	22Ω 1/16W J
R560	2007-000074	CHIP BEAD	30Ω	R2290	T3711-00033	C RESISTOR	1KΩ 1/16W J
R561	2007-000402	CHIP BEAD	30Ω	R2291	AA60-40014A	C RESISTOR	4.7KΩ 1/16W J
R562	2007-000402	CHIP BEAD	30Ω	R2292	AA60-40014A	C RESISTOR	4.7KΩ 1/16W J
R563	2007-000402	CHIP BEAD	30Ω	R2293	T1001-00081A	C RESISTOR	4.7KΩ 1/16W J
R565	2007-000402	CHIP BEAD	30Ω	RA01	T2203-FC220D	C RESISTOR	0Ω 1/16W J
R566	T2203-FC102D	C RESISTOR	10Ω 1/16W J	RA02	T2203-FC330D	C RESISTOR	0Ω 1/16W J
R567	2007-000402	CHIP BEAD	30Ω	RA03	T2203-FC331D	C RESISTOR	33Ω 1/16W J
R568	T2203-FC102D	C RESISTOR	10Ω 1/16W J	RA04	T2203-FC224D	C RESISTOR	33Ω 1/16W J
R571	T2203-FC334D	C RESISTOR	68Ω 1/16W J	RA05	T2203-FC224D	C RESISTOR	33Ω 1/16W J
R572	T2203-FC334D	C RESISTOR	68Ω 1/16W J	RA06	T2203-FC224D	C RESISTOR	33Ω 1/16W J
R573	T2203-FC334D	C RESISTOR	68Ω 1/16W J	RA07	T2203-FC224D	C RESISTOR	33Ω 1/16W J
R574	2401-002235	C RESISTOR	100Ω 1/16W J	RA08	T2203-FC331D	C RESISTOR	33Ω 1/16W J
R575	T2203-FC334D	C RESISTOR	68Ω 1/16W J	RA09	T2203-FC331D	C RESISTOR	33Ω 1/16W J
R577	2007-000075	CHIP BEAD	30Ω	RA10	T2203-FC331D	C RESISTOR	33Ω 1/16W J
R579	2007-000075	CHIP BEAD	30Ω	L201	2007-000309	CHIP BEAD	80Ω
R582	2007-000075	CHIP BEAD	30Ω	L202	2007-000309	CHIP BEAD	80Ω
R583	2007-000075	CHIP BEAD	30Ω	L203	2007-000309	CHIP BEAD	80Ω
R584	2007-000075	CHIP BEAD	30Ω	L204	2007-000309	CHIP BEAD	80Ω
R585	2007-000643	CHIP BEAD	30Ω	L205	2007-000309	CHIP BEAD	80Ω
R586	2007-000643	CHIP BEAD	30Ω	L206	2007-000071	CHIP BEAD	80Ω
R587	2007-000643	CHIP BEAD	30Ω	L207	2007-000071	CHIP BEAD	80Ω
R588	2007-000643	CHIP BEAD	30Ω	L208	2007-000071	CHIP BEAD	80Ω
R589	T2203-FC220D	C RESISTOR	0Ω 1/16W J	L209	2007-000071	CHIP BEAD	80Ω
R591	2007-000643	CHIP BEAD	30Ω	L210	2007-000071	CHIP BEAD	80Ω
R592	2007-000076	CHIP BEAD	30Ω	L211	2007-000113	CHIP BEAD	80Ω
R593	T3722-00040A	C RESISTOR	1KΩ 1/16W J	L214	2007-000113	CHIP BEAD	80Ω
R594	T3722-00041A	C RESISTOR	1KΩ 1/16W J	L215	2007-000113	CHIP BEAD	80Ω
R595	T3711-00038	C RESISTOR	4.7KΩ 1/16W J	L216	2007-000113	CHIP BEAD	80Ω
R596	T3711-00037	C RESISTOR	4.7KΩ 1/16W J	L217	2007-000113	CHIP BEAD	80Ω
R597	T2401-BT102A	C RESISTOR	390Ω 1/16W J	L218	2007-000072	CHIP BEAD	80Ω
R601	T3722-00041A	C RESISTOR	1KΩ 1/16W J	L219	2007-000072	CHIP BEAD	80Ω
R602	T1001-00063A	C RESISTOR	68KΩ 1/16W J	L220	2007-000072	CHIP BEAD	80Ω
R603	2401-000242	C RESISTOR	150Ω 1/16W J	L221	2007-000072	CHIP BEAD	80Ω
R604	T3711-00037	C RESISTOR	4.7KΩ 1/16W J	L302	2007-000072	CHIP BEAD	80Ω
R605	T3722-00041A	C RESISTOR	1KΩ 1/16W J	L303	2007-001134	CHIP BEAD	80Ω
R606	T1001-00086A	C RESISTOR	47KΩ 1/16W J	L304	2007-001134	CHIP BEAD	80Ω
R607	T3711-00037	C RESISTOR	4.7KΩ 1/16W J	L305	2007-001134	CHIP BEAD	80Ω
R608	T1001-00075A	C RESISTOR	30KΩ 1/16W J	L306	2007-000093	CHIP BEAD	500Ω
R609	T3722-00041A	C RESISTOR	1KΩ 1/16W J	L317	T2007-HC330J	CHIP COIL	10uH
R610	T1001-00075A	C RESISTOR	30KΩ 1/16W J	L401	2007-000093	CHIP BEAD	500Ω
R611	T3722-00041A	C RESISTOR	1KΩ 1/16W J	L402	2007-000093	CHIP BEAD	500Ω
R612	T1001-00086A	C RESISTOR	47KΩ 1/16W J	L404	2007-000093	CHIP BEAD	500Ω
R613	2401-002235	C RESISTOR	100Ω 1/16W J	L405	2007-000093	CHIP BEAD	500Ω
R614	2401-002594	C RESISTOR	100Ω 1/16W J	L406	2007-000094	CHIP BEAD	500Ω
R615	2401-002594	C RESISTOR	100Ω 1/16W J	L408	2007-000094	CHIP BEAD	500Ω
R616	2401-002594	C RESISTOR	100Ω 1/16W J	L501	2007-000094	CHIP BEAD	500Ω
R617	2401-002594	C RESISTOR	100Ω 1/16W J	L502	2007-000094	CHIP BEAD	500Ω
R618	2401-002594	C RESISTOR	100Ω 1/16W J	L504	2007-000094	CHIP BEAD	500Ω
R619	T2203-FC100D	C RESISTOR	0Ω 1/16W J	L505	2007-000129	CHIP BEAD	500Ω
R620	T2203-FC100D	C RESISTOR	0Ω 1/16W J	L507	2007-000129	CHIP BEAD	500Ω
R621	T2203-FC220D	C RESISTOR	0Ω 1/16W J	L509	2007-000129	CHIP BEAD	500Ω
R622	T2203-FC220D	C RESISTOR	0Ω 1/16W J	L510	2007-000129	CHIP BEAD	500Ω
R623	T1001-00083A	C RESISTOR	10KΩ 1/16W J	L511	2007-000129	CHIP BEAD	500Ω
R624	T1001-00082A	C RESISTOR	20KΩ 1/16W J	L512	2007-000096	CHIP BEAD	500Ω
R625	T3711-00033	C RESISTOR	1KΩ 1/16W J	L513	2007-000096	CHIP BEAD	500Ω
R629	T2401-CT2210	C RESISTOR	100Ω 1/16W J	L514	2007-000096	CHIP BEAD	500Ω
R630	T1001-00082A	C RESISTOR	20KΩ 1/16W J	L515	2007-000096	CHIP BEAD	500Ω
R631	T1001-00083A	C RESISTOR	10KΩ 1/16W J	L516	2007-000096	CHIP BEAD	500Ω
R632	T2203-FC102D	C RESISTOR	10Ω 1/16W J	L517	2007-000097	CHIP BEAD	500Ω
R633	T3711-00037	C RESISTOR	4.7KΩ 1/16W J	L5VA	2007-000120	CHIP BEAD	80Ω
R701	T2401-CT2210	C RESISTOR	100Ω 1/16W J	L5VB	2007-000120	CHIP BEAD	80Ω
R702	T2401-CT2210	C RESISTOR	100Ω 1/16W J	L5VC	2007-000121	CHIP BEAD	80Ω
R703	T2401-CT2210	C RESISTOR	100Ω 1/16W J	L601	T2007-HC472J	CHIP COIL	10uH
R704	T2801-00013A	C RESISTOR	560Ω 1/16W J	L602	T2007-HC472J	CHIP COIL	10uH
R705	T2801-00012A	C RESISTOR	820Ω 1/16W J	L603	2007-000097	CHIP BEAD	500Ω
R707	T2203-FC103D	C RESISTOR	10Ω 1/16W J	L606	2007-000097	CHIP BEAD	500Ω
R708	T2401-CT2210	C RESISTOR	100Ω 1/16W J	L608	2007-000097	CHIP BEAD	500Ω
R709	T2203-FC103D	C RESISTOR	10Ω 1/16W J	L610	2007-000121	CHIP BEAD	80Ω
R710	T3711-00033	C RESISTOR	1KΩ 1/16W J	L701	2007-000109	CHIP COIL	10uH
R711	T2203-FC330D	C RESISTOR	0Ω 1/16W J				

△Ref No.	Part No.	Part Name	Description	Local	△Ref No.	Part No.	Part Name	Description	Local
L703	2007-000102	SMD COIL	680uH		CE626	T2203-FC100D	E CAPACITOR	1uF 50V M	
L705	2007-000100	SMD COIL	470uH		CE627	2007-000102	E CAPACITOR	47uF 16V M	
L801	2007-000118	CHIP BEAD	80Ω		CE630	T2007-HC472J	E CAPACITOR	22uF 16V M	
L802	2007-000118	CHIP BEAD	80Ω		CE701	2007-000100	E CAPACITOR	100uF 16V M	
L803	2007-000118	CHIP BEAD	80Ω		CE702	T2203-FC102D	E CAPACITOR	10uF 16V M	
L804	2007-000118	CHIP BEAD	80Ω		CE703	2007-000100	E CAPACITOR	100uF 16V M	
L805	2007-000118	CHIP BEAD	80Ω		CE704	2007-000100	E CAPACITOR	100uF 16V M	
L806	2007-000077	CHIP BEAD	80Ω		CE705	T2203-FC100D	E CAPACITOR	1uF 50V M	
L807	2007-000077	CHIP BEAD	80Ω		CE801	T2203-FC103D	E CAPACITOR	220uF 16V M	
L808	2007-000077	CHIP BEAD	80Ω		CE802	T2203-FC221E	E CAPACITOR	470uF 16V M	
L809	2007-000077	CHIP BEAD	80Ω		CE803	2007-000107	E CAPACITOR	47uF 16V M	
L810	2007-000077	CHIP BEAD	80Ω		CE804	2007-000100	E CAPACITOR	100uF 16V M	
L812	2007-000119	CHIP BEAD	80Ω		CE805	T2203-DC104E	E CAPACITOR	220uF 16V M	
L813	2007-000119	CHIP BEAD	80Ω		CE808	T2203-FC104D	E CAPACITOR	220uF 16V M	
L814	2007-000107	SMD COIL	100uH		CE809	T2203-FC224D	E CAPACITOR	1000uF 10V M	
L815	2007-000119	CHIP BEAD	80Ω		CE810	T2203-FC222D	E CAPACITOR	470uF 16V M	
L816	2007-000119	CHIP BEAD	80Ω		CE811	T2203-DC104E	E CAPACITOR	220uF 16V M	
L820	2007-000119	CHIP BEAD	80Ω		J101	2401-002594	CONNECTOR		
L821	2007-000120	CHIP BEAD	80Ω		J102	T2401-CT2210	CONNECTOR		
L822	2007-000120	CHIP BEAD	80Ω		J201	T2203-FC472D	JACK	PC IN	
L823	2007-000120	CHIP BEAD	80Ω		J202	T2203-FC473D	JACK	EXT2	
L830	T3711-00033	C RESISTOR	1KΩ 1/16W J		J203	T2203-FC682D	JACK	EXT-1	
LA01	2007-000121	CHIP BEAD	80Ω		J205	T2203-FC104E	JACK	EXT-3/EXT4	
LA02	2007-000121	CHIP BEAD	80Ω		J209	T2401-FT0R1A	CONNECTOR		
CE101	2007-000097	E CAPACITOR	100uF 16V M		J210	2401-000269	CONNECTOR		
CE102	2007-000107	E CAPACITOR	47uF 16V M		J303	T2203-BC106E	CONNECTOR		
CE103	2007-000109	E CAPACITOR	22uF 16V M		J304	2401-001495	CONNECTOR		
CE105	T2203-FC220D	E CAPACITOR	10uF 16V M		J501	2401-000603	CONNECTOR		
CE107	T2203-FC060D	E CAPACITOR	1uF 50V M		J601	T2401-CT4700	CONNECTOR		
CE108	2007-000096	E CAPACITOR	0.1uF 50V M		J602	2401-000914	CONNECTOR		
CE202	T2203-FC220D	E CAPACITOR	10uF 16V M		J801	2401-002235	CONNECTOR		
CE203	T2203-FC220D	E CAPACITOR	10uF 16V M		RN301	2007-000084	BEAD ARRAY	120Ω	
CE204	T2203-FC220D	E CAPACITOR	10uF 16V M		RN302	2007-000084	BEAD ARRAY	120Ω	
CE205	T2203-FC220D	E CAPACITOR	10uF 16V M		RN303	2007-000084	BEAD ARRAY	120Ω	
CE206	T2203-FC103D	E CAPACITOR	220uF 16V M		RN304	2007-000084	BEAD ARRAY	120Ω	
CE207	T2203-FC103D	E CAPACITOR	220uF 16V M		RN305	2007-000084	BEAD ARRAY	120Ω	
CE220	2007-000097	E CAPACITOR	100uF 16V M		RN306	2007-000090	BEAD ARRAY	120Ω	
CE221	2007-000097	E CAPACITOR	100uF 16V M		RN307	2007-000090	BEAD ARRAY	120Ω	
CE301	T2203-FC150D	E CAPACITOR	100uF 10V M		RN308	T1001-00079A	CHIP ARRAY	4.7KΩ 1/16W J	
CE302	T2203-CC105D	E CAPACITOR	100uF 10V M		RN309	2007-000090	BEAD ARRAY	120Ω	
CE402	2007-000109	E CAPACITOR	22uF 16V M		RN310	T1001-00079A	CHIP ARRAY	4.7KΩ 1/16W J	
CE404	T2203-FC330D	E CAPACITOR	10uF 16V M		RN408	2007-000078	BEAD ARRAY	30Ω	
CE405	T2203-FC330D	E CAPACITOR	10uF 16V M		RN409	2007-000078	BEAD ARRAY	30Ω	
CE407	T2203-FC330D	E CAPACITOR	10uF 16V M		RN410	2007-000078	BEAD ARRAY	30Ω	
CE408	T2203-FC330D	E CAPACITOR	10uF 16V M		RN411	2007-000078	BEAD ARRAY	30Ω	
CE410	T2203-FC221E	E CAPACITOR	470uF 16V M		RN412	T1001-00049A	CHIP ARRAY	33Ω 1/16W J	
CE411	T2203-FC152D	E CAPACITOR	4.7uF 50V M		RN413	T1001-00049A	CHIP ARRAY	33Ω 1/16W J	
CE412	T2203-FC330D	E CAPACITOR	10uF 16V M		RN414	T1001-00049A	CHIP ARRAY	33Ω 1/16W J	
CE413	T2203-FC470D	E CAPACITOR	10uF 16V M		RN415	T1001-00049A	CHIP ARRAY	33Ω 1/16W J	
CE414	T2203-FC152D	E CAPACITOR	4.7uF 50V M		RN416	T1001-00049A	CHIP ARRAY	33Ω 1/16W J	
CE415	T2203-FC470D	E CAPACITOR	10uF 16V M		RN417	T1001-00078A	CHIP ARRAY	33Ω 1/16W J	
CE416	T2203-FC152D	E CAPACITOR	4.7uF 50V M		RN418	T1001-00078A	CHIP ARRAY	33Ω 1/16W J	
CE502	T2203-FC104D	E CAPACITOR	220uF 16V M		RN503	2007-000081	BEAD ARRAY	30Ω	
CE503	2007-000097	E CAPACITOR	100uF 16V M		RN505	2007-000081	BEAD ARRAY	30Ω	
CE504	2007-000107	E CAPACITOR	47uF 16V M		RN508	2007-000081	BEAD ARRAY	30Ω	
CE506	2007-000109	E CAPACITOR	22uF 16V M		RN509	2007-000081	BEAD ARRAY	30Ω	
CE507	2007-000109	E CAPACITOR	22uF 16V M		RN510	2007-000082	BEAD ARRAY	30Ω	
CE508	2007-000102	E CAPACITOR	47uF 16V M		RN511	2007-000082	BEAD ARRAY	30Ω	
CE509	2007-000109	E CAPACITOR	22uF 16V M		RN512	2007-000082	BEAD ARRAY	30Ω	
CE510	T2007-HC330J	E CAPACITOR	22uF 16V M		RN513	2007-000078	BEAD ARRAY	30Ω	
CE511	T2007-HC330J	E CAPACITOR	22uF 16V M		RN514	2007-000082	BEAD ARRAY	30Ω	
CE512	T2007-HC330J	E CAPACITOR	22uF 16V M		RN515	2007-000123	BEAD ARRAY	30Ω	
CE513	T2007-HC330J	E CAPACITOR	22uF 16V M		RN516	2007-000123	BEAD ARRAY	30Ω	
CE514	T2007-HC330J	E CAPACITOR	22uF 16V M		RN517	2007-000123	BEAD ARRAY	30Ω	
CE515	T2007-HC472J	E CAPACITOR	22uF 16V M		RN518	2007-000123	BEAD ARRAY	30Ω	
CE516	T2007-HC472J	E CAPACITOR	22uF 16V M		RN519	2007-000123	BEAD ARRAY	30Ω	
CE517	T2203-FC470D	E CAPACITOR	10uF 16V M		RN520	2007-000081	BEAD ARRAY	30Ω	
CE518	2007-000097	E CAPACITOR	100uF 16V M		X301	T2203-FC331D	CRYSTAL	6MHz	
CE601	T2203-FC103D	E CAPACITOR	220uF 16V M		X401	T2203-FC392D	CRYSTAL	27MHz	
CE602	T2203-FC103D	E CAPACITOR	220uF 16V M		X501	T2203-FC332D	CRYSTAL	14.318MHz	
CE603	2007-000102	E CAPACITOR	47uF 16V M		X601	T2203-FC334D	CRYSTAL	18.432MHz	
CE604	2007-000102	E CAPACITOR	47uF 16V M						
CE605	T2203-FC060D	E CAPACITOR	1uF 50V M						
CE606	T2203-CC105D	E CAPACITOR	100uF 10V M						
CE607	T2203-FC470D	E CAPACITOR	10uF 16V M						
CE608	T2203-FC470D	E CAPACITOR	10uF 16V M						
CE609	T2203-FC101D	E CAPACITOR	10uF 16V M						
CE610	T2203-FC101D	E CAPACITOR	10uF 16V M						
CE611	T2203-FC101D	E CAPACITOR	10uF 16V M						
CE612	2007-000102	E CAPACITOR	47uF 16V M						
CE613	T2203-FC101D	E CAPACITOR	10uF 16V M						
CE614	T2203-FC101D	E CAPACITOR	10uF 16V M						
CE617	T2203-FC102D	E CAPACITOR	10uF 16V M						
CE620	T2203-FC102D	E CAPACITOR	10uF 16V M						
CE621	T2203-FC102D	E CAPACITOR	10uF 16V M						
CE622	T2203-FC060D	E CAPACITOR	1uF 50V M						
CE623	T2203-FC060D	E CAPACITOR	1uF 50V M						
CE624	T2203-FC102D	E CAPACITOR	10uF 16V M						
CE625	T2203-FC060D	E CAPACITOR	1uF 50V M						

POWER P.W. BOARD ASS'Y (QAL0826-001)

REFER TO PARTS LIST IN PAGE 3-10 FOR THIS P.W. BOARD.

LED P.W. BOARD ASS'Y (QAL0827-001)

REFER TO PARTS LIST IN PAGE 3-12 FOR THIS P.W. BOARD.

KEY P.W. BOARD ASS'Y (QAL0828-001)

REFER TO PARTS LIST IN PAGE 3-12 FOR THIS P.W. BOARD.

REMOTE CONTROL UNIT PARTS LIST (RM-C1816S-2C)

△ Ref.No.	Part No.	Part Name	Description	Local
	2AA070311	BATTERY COVER		

PACKING

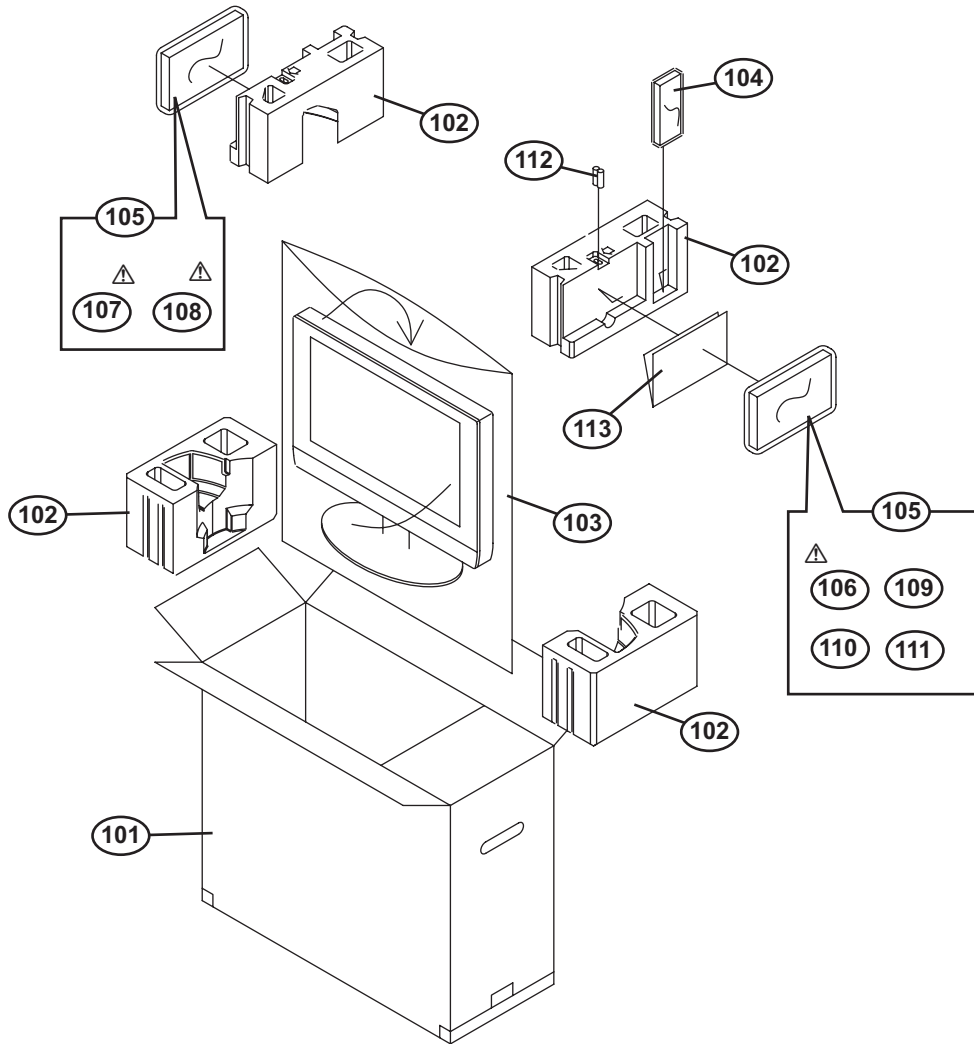

PACKING PARTS LIST

△ Ref.No.	Part No.	Part Name	Description	Local
101	GA10002-056A-U	PACKING CASE		LT-26A61BJ,LT-26A61BU,LT-26A61BU/C,LT-26A61SJ,LT-26A61SU,LT-26A61SU/C
101	GA10002-057B-U	PACKING CASE		LT-32A61BJ,LT-32A61BU,LT-32A61BU/C,LT-32A61SJ,LT-32A61SU,LT-32A61SU/C
102	GA10046-001A-U	CUSHION ASSY	4pcs in 1set	LT-26A61BJ,LT-26A61BU,LT-26A61BU/C,LT-26A61SJ,LT-26A61SU,LT-26A61SU/C
102	GA10049-001A-U	CUSHION ASSY	4pcs in 1set	LT-32A61BJ,LT-32A61BU,LT-32A61BU/C,LT-32A61SJ,LT-32A61SU,LT-32A61SU/C
103	GA10026-001A-U	FOAM BAG		LT-26A61BJ,LT-26A61BU,LT-26A61BU/C,LT-26A61SJ,LT-26A61SU,LT-26A61SU/C
103	GA10026-002A-U	FOAM BAG		LT-32A61BJ,LT-32A61BU,LT-32A61BU/C,LT-32A61SJ,LT-32A61SU,LT-32A61SU/C
104	RM-C1816S-2C	REMOTE CONTROL UNIT		
105	GA30007-001A-U	DOCUMENT BAGS		LT-26A61BJ,LT-26A61SJ,LT-32A61BJ,LT-32A61SJ
105	GA30007-001A-U	DOCUMENT BAGS	(x2)	LT-26A61BU,LT-26A61BU/C,LT-26A61SU,LT-26A61SU/C,LT-32A61BJ,LT-32A61BU,LT-32A61BU/C,LT-32A61SU,LT-32A61SU/C
△ 106	LCT1999-001A-U	INST BOOK	English	LT-26A61BJ,LT-26A61SJ,LT-32A61BJ,LT-32A61SJ
△ 106	LCT1996-001A-U	INST BOOK	English/German/French/Dutch/Spanish/Italian/Portuguese	LT-26A61BU,LT-26A61BU/C,LT-26A61SU,LT-26A61SU/C,LT-32A61BU,LT-32A61BU/C,LT-32A61SU
△ 106	LCT1996-001B-U	INST BOOK	English/German/French/Dutch/Spanish/Italian/Portuguese	LT-26A61SU/C,LT-32A61SU/C
△ 107	LCT1997-001A-U	INST BOOK	Norwegian/Finn/Danish/Swedish	LT-26A61BU,LT-26A61BU/C,LT-26A61SU,LT-26A61SU/C,LT-32A61BU,LT-32A61BU/C,LT-32A61SU
△ 107	LCT1997-001B-U	INST BOOK	Norwegian/Finn/Danish/Swedish	LT-26A61SU/C,LT-32A61SU/C
△ 108	LCT1998-001A-U	INST BOOK	Russian/Polish/Czech/Hungarian/Romanian/Bulgarian	LT-26A61BU,LT-26A61BU/C,LT-26A61SU,LT-26A61SU/C,LT-32A61BU,LT-32A61BU/C,LT-32A61SU
△ 108	LCT1998-001B-U	INST BOOK	Russian/Polish/Czech/Hungarian/Romanian/Bulgarian	LT-26A61SU/C,LT-32A61SU/C
109	-----	WARRANTY CARD	BT-54027-1E	
110	LCT1923-001A-U	SHEET(WEEE)-E		LT-26A61BJ,LT-26A61SJ,LT-32A61BJ,LT-32A61SJ
110	LCT1923-002A-U	SHEET(WEEE)-E		LT-26A61BU,LT-26A61BU/C,LT-26A61SU,LT-26A61SU/C,LT-32A61BU,LT-32A61BU/C,LT-32A61SU,LT-32A61SU/C
111	GA30011-001A-U	REGISTRATION CARD		LT-26A61BJ,LT-26A61SJ,LT-32A61BJ,LT-32A61SJ
112	-----	BATTERY	R6P/AA(x2)	
113	LCT1504-001A-U	CAUTION SHEET		